



Ustalık Eseri

Bu eser, kerpeten montaj hattında çalışan Mehmet Ali Usta'nın ellerinde alın teri ve emekle 13 yılda şekillendi.



Tüm ustalarımızın eserlerine saygıyla...

GARANTİ ŞARTLARI / WARRANTY CONDITIONS

A-KAPSAM İÇİ

1. Normal kullanım şartlarına uygun kullanılan ancak, imalat veya malzeme hatası tespit edilen ürünler, ömür boyu garanti kapsamında, tamir edilir veya mümkün değilse, derhal yenisi ile değiştirilir.



B-KAPSAM DIŞI

Aşağıda yazılı şartlarda kullanılan aletler, garanti kapsamı dışında olup, yenisi ile değiştirilmezler.

1. Kullanım amacı veya kullanma talimatı dışında kullanılmış olan ürünler.
2. Aşırı zorlama ile, boru takılarak veya çekiçle vurularak darbeli kullanım sonucu deforme olmuş ya da kırılmış olan ürünler.
3. Kullanıcı tarafından üzerinde taşlama, zımparalama, delme veya kaynak yapılarak orijinal hali bozulmuş olan ürünler.
4. Kullanıldıktan sonra, gerekli koruyucu bakımları yapılmadan, tozlu, rutubetli ve çamurlu ortamlarda bekletilerek fonksiyonu kaybolmuş ürünler.
5. Uygun olmayan rutubetli ortamlarda, uzun süre stoklanarak, paslanmış, korozyona uğramış olanlar.
6. Uzun süre kullanılmış veya kullanım ömrünü tamamlamış, buna bağlı olarak eskimiş, yıpranmış, deforme olmuş ürünler.

EMNİYETLİ VE DOĞRU EL ALETİ KULLANIM KURALLARI

A-UYULMASI GEREKEN KURALLAR:

1. Anahtarın ölçüsünün kullandığınız parçaya göre uygun olduğundan emin olunuz.
2. Kullanım esnasında aletin doğru şekilde yerleştirildiğinden emin olunuz.
3. Aleti sık kontrol ediniz. Aşınmış, zarar görmüş aletleri değiştiriniz.
4. Aleti kullanım şartlarına uygun olarak kullanınız, aşırı yük uygulamayınız.
5. Özellikle çekiçlerde vurma yüzeyinin, vurulan yüzeyden daha büyük olmak zorunda olduğuna dikkat ediniz.
6. Havalı aletlerde daima uygun aksesuarı kullanınız. (Ayrıca basınçlı havanın yağlandığından emin olunuz.)
7. Çalışma şartlarına göre uygun kişisel koruma teçhizatı kullanınız.
8. Tekerlekli takım dolaplarını, daima kapılarını ve hareketli bölümlerini kilitledikten sonra hareket ettiriniz.
9. Tekerlekli takım dolabı üzerinde çalışırken, tekerleklerini frenleyiniz.
10. Yüksek gerilimli çalışma ortamlarında TS EN IEC 60900 Standartına uygun olarak üretilmiş VDE belgeli ürünleri kullanınız.
11. Aletlerin nemli ve ıslak ortamlarda kullanımı ardından mutlaka kurutunuz ve hafif yağlayınız.

B-YAPILMAMASI GEREKEN İŞLEMLER:

1. Boru vb. uzatmalar kullanarak olması gereken tork gücünü aşmayınız. (Özellikle tüm anahtarlarda)
2. Hiçbir aleti üretim maksadına aykırı işlerde kullanmayınız. (örneğin: tornavidanın levye veya keski gibi kullanımı)
3. Aşırı güç uygulayarak (boru takarak veya çekiçle vurarak) aleti zorlamayınız. (örneğin: anahtarlar ve tornavidalar)
4. Hiçbir zaman, kullandığımız aleti kendinden daha sert olan bir cisme vurmayınız. (örneğin: çekiç ve keski)
5. Aletleri değişikliğe uğratmayınız. (Şekli veya bir kısmını)
6. Metrik ölçülü anahtarları, inch ölçülü civatalarda kullanmayız veya tersini yapmayınız.
7. Yıpranmış ve hatalı aletleri kullanmayınız.
8. Tekerlekli tamir dolabı dolu iken, birden fazla çekmeceyi açık tutmayınız, çekmeceler açıkken hareket ettirmeyiniz.
9. Aletin fonksiyonunu iyileştirmek maksadı ile üzerinde zımpara, taş, kaynak vb. işlem yapmayınız.
10. Aletin kullanımı sırasında boya veya kaplamanın çıkacağı etkilere maruz bırakmayınız. Aksi halde korozyon dayanımı negatif etkilenecektir.
11. İzolasyonu zedelenmiş, sapı yıpranmış VDE sertifikalı ürünleri hiçbir şekilde yüksek gerilim ihtiva eden ortamlarda kullanmayınız.
12. Kontrol kaleminin iç mekanizmasını kesinlikle sökmeye çalışmayınız. Kontrol kalemleri 110 – 250 VAC çalışma aralığı için uygundur.
13. Yukarıda bahsedilen şartlara ve doğru kullanıma riayet ederek, her zaman amaca yönelik uygun aletleri kullanınız.

A- INCLUDED CASES

1. *Products used in accord with normal use conditions but found to have production or material errors will be repaired or if this is not possible replaced immediately under lifetime warranty.*

B- EXCLUDED CASES

Products used under any of the conditions listed below are excluded from the warranty scope and cannot be replaced with new ones:

1. *Products used outside the intended purpose or instructions of use;*
2. *Products deformed or broken due to excessive forcing, pipe attachment or hammer impact;*
3. *Products whose original form is altered by the user by stoning, grinding, perforation or welding;*
4. *Products which lost their function due to being left in dusty, moist or muddy environments without necessary protective maintenance after use;*
5. *Products which became rusted or corroded due to being stored in unsuitable, moist environments for extended periods of time;*
6. *Products which are used for a long period of time or which have completed their useful life and accordingly have become old, worn out and deformed.*

RULES FOR SAFE AND CORRECT USE OF HAND TOOL

A- PRACTICAL RULES:

1. *Make sure size of the wrench is appropriate for the work piece.*
2. *Make sure the tool is positioned correctly during use.*
3. *Frequently control the tool. Replace worn or damaged tools.*
4. *Use the tool in accord with instructions of use. Do not place too much load on the tool.*
5. *Especially beware of the point that the impact surface of a hammer must be larger than the impacted surface.*
6. *Always use appropriate accessories for pneumatic tools. (Also make sure the pneumatic system is properly lubricated.)*
7. *Use personal protection equipment appropriate for work conditions.*
8. *Always make sure to lock lids and moving parts of wheeled set cabinets before moving them.*
9. *Make sure to lock brakes of the wheeled set cabinets before working on them.*
10. *Use VDE certified products made in accord with TS EN IEC 60900 Standard in high voltage work environments.*
11. *Make sure to dry and lightly lubricate tools after use in moist and wet environments.*

B- ACTIONS TO AVOID:

1. *In case of use with extensions like pipes, etc. do not exceed the specified torque value (especially in case of all wrenches).*
2. *Do not use any tool outside of its intended purpose (e.g. do not use a screwdriver as a lever or a chisel).*
3. *To not force the tool (e.g. wrenches and screwdrivers) by using excessive force (by pipe attachment or hammer impact).*
4. *Never use the tool to hit another object harder than the tool (e.g. hammer and chisels).*
5. *Do not alter the tools (in form or partially).*
6. *Do not use metric sized wrenches on inch sized bolts or vice-versa.*
7. *Do not use worn out or faulty tools.*
8. *Do not leave multiple drawers open when using the wheeled set cabinet and do not move the cabinet while the drawers are open.*
9. *Do not perform grinding, stoning, welding, etc. on the tool in order to improve its function.*
10. *Do not expose the tool to conditions that might result in loss of paint or coating during use. Otherwise corrosion resistance of the tool will be affected.*
11. *Never use VDE certified products with damaged or worn isolation or handle in high voltage work environments.*
12. *Never attempt to dismantle the internal assembly of the tester. Testers are suitable for use in the 110 – 250 VAC operation range.*
13. *Always use the right tool for the right job and follow the conditions and rules of correct usage detailed above.*

Yarım asırlık 'güven'

Kalite yolculuğu inanmakla başlar.

Türkiye'nin ilk ve en büyük el aletleri üreticisi İZELTAŞ, 1968 yılında Ege'nin gözbebeği İzmir'den işte bu inançla yola çıktı. Yüzde 100 Türk sermayesiyle oluşturulan ve günden güne büyüyen İZELTAŞ, modern teknolojiyle donatılmış dev tesislerinde üretilen dört bin beş yüz den fazla ürünle 40 ülkeye ihracat yaparak hem kendi insanına hem de ülke ekonomisine katkı sağlıyor.

El aletlerinin yanı sıra üretilen dövme parçalar ile başta otomotiv olmak üzere inşaat, denizcilik ve madencilik sektörüne, savunma ve havacılık sanayilerine, ziraat endüstrisine, altyapı işlerine dek birçok kamu ve özel sektör kuruluşuna hizmet sunuyor.

Daha iyisi, daha yenisi için...

Kalıphane, dövme, işleme, ısıtma işlemi, krom-nikel kaplama, boyama, plastik daldırma, plastik enjeksiyon ve markalama departmanlarından oluşan dünyadaki ender entegre fabrikalardan İZELTAŞ'ta üretimin her aşamasında kalite kontrolüne tabi tutulan ürünler; fiziksel, metalürjik, kimyasal ve elektriksel testlerden geçirilerek İZELTAŞ güvencesine alınıyor. Ar-Ge ve inovasyon ışığında değişime ve gelişime her daim açık olan İZELTAŞ, bu sayede gücüne güç katıyor.

T.C. Sanayi ve Teknoloji Bakanlığında AR-GE Merkezi belgesine sahip İZELTAŞ, TS EN ISO 9001 Kalite Yönetim Sistemi, ISO/IEC 27001 Bilgi Güvenliği Yönetim Sistemi, TS (OHSAS) 18001 İş Sağlığı ve Güvenliği Yönetim Sistemi, TS EN ISO 14001 Çevre Yönetim Sistemi, TS EN ISO 50001 Enerji Yönetim Sistemleri; TSE, TSEK, VDE GS ürün kalite belgeleri ve yüksek teknolojisi ile sadece Türkiye'de değil, dünyada da farkını ortaya koyuyor.

Önce güvenlik, sonra üretim

İnsan önemli, emek değerlidir. İZELTAŞ, "Önce güvenlik" anlayışından ayrılmadan, çalışanları için önlem almaya, onları iş sağlığı ve güvenliği konusunda eğitmeye devam ediyor. Çünkü; "İnsan vücudunun yedek parçası yoktur"

Size ulaştıktan sonra...

Satış sonrasında tüketici haklarını koruma ve sınırsız hizmet anlayışı İZELTAŞ'ın vazgeçilmez şirket politikalarından birini oluşturuyor.

Dolayısıyla...

- El aletleri' dendiğinde akla gelen ilk isim olabildiysek,
- Yarım asırdır 'aileden biri' olmanın hakkını verebildiysek,
- 'Türk malı' sözünün altına imzamız atabildiysek,
- 'Yıllarca kullanılır' diyerek her zaman tercih edildiysek,

Gücümüzü, şevkimizi ve inancımızı siz değerli bayilerimiz ve tüketicilerimizden alıyoruz.

850 çalışanımızla birlikte üreterek, değer sağlayarak dünya markası olmanın haklı gururunu yaşıyoruz.

Nice başarılı yıllara!

Half a century of reliability

Faith is the essential step on the journey to achieve utmost quality.

As the first and largest hand tool manufacturer of Turkey, İZELTAŞ, had this faith as it started its journey in 1968 in İzmir, the beautiful city in the Aegean region. Its establishment, consisting of 100% national capital, İZELTAŞ has grown in years into an industrial giant with huge facilities equipped with state-of-the-art technologies and over 4500 products. Exporting to more than 40 countries, the company is a prominent contributor to not only the Turkish economy but also the community.

Along with manufacturing hand tools, İZELTAŞ produces forged steel parts for various industries like automotive, construction, maritime, mining, aviation, defence, agriculture and infrastructure.

Newer and better

İZELTAŞ is one of the few fully integrated factories in the world that consists of die tooling, forging, processing, heat processing, chrome-nickel plating, dyeing, pvc coating, plastic injection and marking departments. Every stage of the production is tested for quality assurance using physical, metallurgical, chemical and electrical methods. R&D and innovation are the key words that empower İZELTAŞ as a company which embraces development and improvement as its main philosophy.

İZELTAŞ is an accredited R&D Center by the Ministry of Science, Industry and Technology and has been certified with the following: ISO 9001 Quality Management System, ISO/IEC 27001 Informationsecurity Management System, OHSAS 18001 Occupational Health and Safety Management System, ISO 14001 Environment Management System, ISO 50001 Energy Management System certification, TSE, TSEK and VDE GS product certification.

Safety before production

Humans are the most significant factors of any industry and their labour is precious. Health and safety awareness is the fundamental policy of İZELTAŞ. The company continuously organizes training programs on occupational health and safety which emphasise that safety comes first and it is not possible to fix humans by changing the damaged organs with spare ones.

Customer satisfaction

Another fundamental policy of İZELTAŞ is the customer satisfaction. The company is dedicated to serve its customers and protect their rights as consumers.

Hence...

- We are the first brand that comes to mind in the hand tools industry
- We are valued almost as a part of the families of our consumer
- We have proved ourselves worthy of the statement "Made in Turkey"
- We have been the first choice of the consumers for durability over the years

Our power, enthusiasm and faith are derived from our distinguished dealers and consumers.

We are proud to have become a world brand with our 850 employees who strive everyday to contribute to the productivity of the company, creating an added value for the economy and our community.

To many successful years to come!

Takım Dolapları ve Takım Çantaları
Tool Trolleys, Tool Boxes



5-37

Anahtarlar
Wrenches



38-60

Lokma ve Bijon Anahtarları
Sockets and Rim Wrenches



61 -90

Boru Anahtarları ve Penseler
Pipe Wrenches and Pliers



91-109

1000V Grubu Ürünler
1000V Product Group

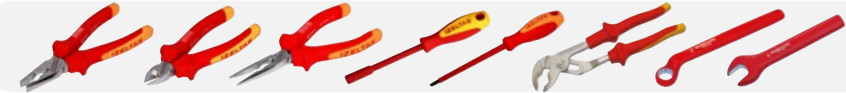

111-119

Tornavida ve Allen Anahtarlar
Screwdrivers and Hex Key Wrenches



121-144

Keskiler ve Çekiçler
Chisels and Hammers



145-151

Genel El Aletleri
General Hand Tools



153-164

Makaslar
Shears



165-171

Çektirmeler
Pullers



173-179



181-198

Yedek Parçalar
Spare Parts



199-203

Ticari Teşhir Standları
Commercial Display Stands



205-208

Teknik Bilgiler ve İndeks
Technical Information and Index



209-236



*"Sadece el aleti üretmiyoruz;
el aletleriyle her şeyi üretiyoruz."*

*"We don't just produce hand tools;
we build everything with hand tools."*

İZELTAS®

TAKIM DOLAPLARI TAKIM ÇANTALARI VE ALET SETLERİ

TOOL TROLLEYS, TOOL BOXES AND
HAND TOOL SETS



Takim Dolapları
Tool Cabinets

Takim Çantaları
Tool Boxes

Servis Masaları
Service Tables

Alet Setleri
Tool Sets



İZELTAS YOUTUBE



8245 PREMIUM SERİSİ / PREMIUM SERIES

Premium Serisi Takım Dolabı (5-7 Çekmeceli)
Premium Series Workshop Trolley (5-7 Drawers)



✓ 6 bölmeli sağlam ve dayanıklı ABS plastik üst malzeme tabla.
● Resistant and solid top cover having 6 divisions

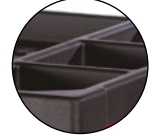

✓ %100 açılabilir teleskobik raylar.
● %100 extendable telescopic slides



✓ Merkezi kilit
✓ Mandal sistemi
✓ Devrilme emniyet sistemi
● Central lock
● Handgrip Lock system
● Anti tilt system



✓ 2 sabit, 2 hareketli frenli tekerlek ø 125mm
● 2 swivel castors with brake
2 fixed castors ø 125mm



✓ Standard tutma sapı
● Standard handle



✓ Plastik köşe koruma
● Plastic corner protection



✓ Yüksek dayanımlı elektrostatik toz boya.
● High strength electrostatic powder coating.

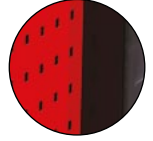

✓ Havluluk x1
Avadanlık x2 Askılık x1
● Paper Roll Holder
x 1 Bottle & Tins Holder x2 Hanger x1

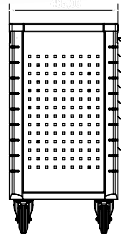
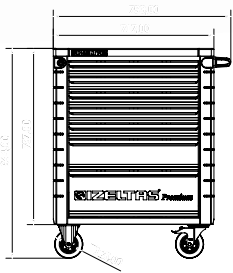
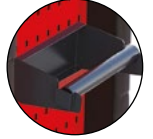



Ölçü/Size: 485x717x944 mm

Sacdan imal edilmiş, Fırın boya
Made of sheet metal, Electrostatic paint



IZELTAS YOUTUBE

KOD/CODE	ÇEKMECE DRAWERS	 35 kg	 35 kg	 35 kg	Kg	RENK COLORS	FİYAT TL/Ad
8245 32 1005	5	400x548x62	400x548x132	400x548x201	64		3723,95
8245 32 1007	7	5X	1X	1X	70	RAL 9005 RAL 3020	4820,95
8245 00 7096 Dolu/Full 242 Parça/Pcs	7	5X	1X	1X			13768,95



1. Premium Seri Çekmece/Drawer Kod / Code 8245001042

KOD CODE	İÇERİK CONTENTS	□	FIYAT TL/Ad
0100	İki Ağız Anahtar Kısa Boy D/E Open jaw wrenches Short Pattern 6x7-8x9-10x11-12x13-14x15-16x17-18x19-20x22	8	
0320	Kombine Anahtar Kısa Boy Combination wrenches Short Pattern 6-7-8-9-10-11-12-13-14-15-16-17-18-19-20-21-22-24-27-30-32	21	1687,20
0430	Yıldız Anahtar Ring Wrenches 6x7-8x9-10x11-12x13-14x15-16x17-18x19-20x22	8	
0340	Cırcır Kombine Anahtar / Combination Wrench With Ratchet 8-10-13-17-19	5	

2. Premium Seri Çekmece/Drawer Kod / Code 8245002094

KOD CODE	İÇERİK CONTENTS	□	FIYAT TL/Ad
1107	1/4" Lokmalı Allen Uçlar / Hexagonal Bits Socket 2,5 - 3 - 4 - 5 - 6 - 7 - 8 - 10	8	
1107	1/4" Lokmalı Torx Uç / Torx Bits Socket T8-T9-T10-T15-T20-T25-T27-T30-T40	9	
1107	1/4" Lokmalı Yıldız Uç / Phillips Bits Socket PH1-PH2-PH3	3	
1107	1/4" Lokmalı Düz Uç / Slotted Bits Socket 3 - 4 - 5,5 - 6,5	4	
1107	1/4" Altı Köşe Derin Lokma / Deep Socket Wrench 6 Point 4-5-5,5-6-7-8-9-10-11-12-13	11	
1113	1/2" Lokmalı Allen Uç / Hexagonal Bits Socket 5-6-7-8-10-12-14	7	
1113	1/2" Lokmalı Torx Uç / Torx Bits Socket T20-T25-T27-T30-T40-T45-T50-T55-T60	9	
1107	4 - 5 - 6 7 - 8 - 9 - 10 11 - 12 - 13 Altı Köşe Six Points 1/4" Altı Köşe Lokma Takımı / Socket Wrench Set 1/4" Cırcır kolu / Ratchet Handle	15	1983,00
	1/4" Mafsalsal / Universal Joint 1/4" T Kol / Sliding T Handle		
1113	1/4" Ara Kol / Extension Bar 50-100 mm 1/2" Buji Lokma Lastikli Spark Plug Socket With Rubber 16 mm	1	
1113	1/2" Lokma Takımı / Socket Wrench Set 1/2" Cırcır Kolu 32 Diş / Ratchet Handle 1/2" Mafsalsal / Universal Joint	24	
	10 - 11 - 12 - 13 14 - 15 - 16 - 17 18 - 19 - 21 - 22 23 - 24 - 26 - 27 28 - 30 - 32 Altı Köşe Six Points 1/2" T Kol Adaptör / Sliding T Handle Adapter 1/2" Ara Kol / Extension Bar 125-250 mm		

3. Premium Seri Çekmece/Drawer Kod / Code 8245003014

KOD CODE	İÇERİK CONTENTS	□	FIYAT TL/Ad
3700	Yan Keski Opak Seri / Side Cutting Pliers 160 mm	1	
3020	Kombine Pense Opak Seri / Combination Pliers 180 mm	1	
3220	Kargaburun Düz Uçlu Opak Seri / Nose Pliers Flat 180 mm	1	
4300	Opak Seri Düz Uçlu Tornavida / Screwdriver, Flat 3x80-5x125-7x150	3	
4320	Opak Seri Yıldız Uçlu Tornavida / Screwdriver, Phillips 3x60-4.5x80-6x100-8x150	4	905,90
3301	Dış segman Pensi Düz / Circlip Pliers, External Flat 140-180mm	2	
3321	İç segman Pensi Düz / Circlip Pliers, Internal Flat 140-180mm	2	

4. Premium Seri Çekmece/Drawer Kod / Code 8245004043

KOD CODE	İÇERİK CONTENTS	☐	FİYAT TL/Ad
4770	Lokma Uçlu Tornavida / Nutspinner 6-7-8-9-10-13	6	976,00
4910	Torx Allen Takım / Torx Key Wrench Set T9-T10-T15-T20-T25-T27-T30-T40	8	
4900	Allen Takımı 6 Köşe / Hex Key Wrench Set 2-2.5-3-3.5-4-5-6-7-8-9-10-12	12	
4906	Yuvarlak Başlı Uzun Allen Takımı / Hex key Wrench Ballpoint Long Pattern Set 1,5-2-2,5-3-4-5-6-8-10	9	
4920	T Tipi Allen Anahtar / T Type Hex Key Wrench 2.5-3-4-5-6-7-8-10	8	

5. Premium Seri Çekmece/Drawer Kod / Code 8245005043

KOD CODE	İÇERİK CONTENTS	☐	TL/Ad.
4565	Oto Elektrik Kontrol Kalemi Car Voltage Tester 135mm	1	1105,15
07415	Sıralı Tel Fırça 4 Sıralı / Hand Brush 4 Raws	1	
2400	Üniversal Fort Pense / Universal Grip 240 mm	1	
2500	Üniversal Ayarlı Pense Universal Grip 250 mm	1	
0600	Kurbağacık Anahtar / Adjustable Wrench 10"	1	
4780	Manyetik Bits Tutucu Tornavida / Screwdriver, Magnetic Bit Holder 6.3x120	1	
4800	31'li Bits Set (Plastik Kutulu) / Bits Set in plastic case	31	
4110	Düz Topaç Tornavida / Screwdriver, Stubby, Flat 6.5x25	1	
4130	Yıldız Topaç Tornavida / Screwdriver, Stubby, Phillips 6x25	1	
5500	Düz Keski Krom Flat Cold Chisel 150 mm	1	
5800	Tesviyeci Çekici Machinist's Hammer 300-1500 gr	2	
6350	Levye Oluklu / Tyre Lever 500 mm	1	

6. Premium Seri Çekmece/Drawer Kod / Code 8245006009

KOD CODE	İÇERİK CONTENTS	☐	FİYAT TL/Ad
1855	Mafsallı T Kol Lokma T- Handle Wrench with Universal Join 8-10-12-13-17-19	6	2290,75
6230	Gres Pompası Grease Gun 500cc	1	
06375	Ayarlı Yağ Filtre Sökeceği Adjustable Slot Type Oil Filter Wrench	1	
6225	Madeni Yağdanlık (Flexible Uçlu) Oiler With Flexible Spout 200cc	1	



8241 PRO SERİSİ / PRO SERIES

Pro Serisi Takım Dolabı (5-6-7-8 Çekmeceli)
Pro Series Workshop Trolley (5-6-7-8 Drawers)



✓ Merkezi kilit sistemi, mandal sistemi ve devrilme emniyet sistemi.
● Central lock system, handgrip lock system and antitilt system.



✓ Teleskobik rulmanlı kızaklar tüm çekmeceler %100 açılabilir.
● Telescopic slides which are %100 extendable.



✓ 8 bölümlü sağlam ve dayanıklı ABS plastik üst malzeme tabla.
● Durable ABS worktop with 8 divisions



✓ 2 sabit, 2 hareketli frenli tekerlek Ø 125mm
● 2 swivel castors with brake, 2 fixed castors Ø 125mm



✓ Yüksek dayanımlı elektrostatik toz boya.
● High strenght electrostatic powder coating



Ölçü/Size: 470x670x1007 mm

Sacdan imal edilmiş, Fırın boya
Made of sheet metal, Electrostatic paint

✓ Toplam 6 Adet yan ve arka avadanlık bölümleri.
● 6 tool holders

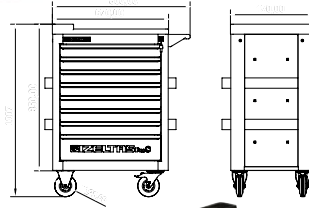

KOD/CODE	ÇEKMECE DRAWERS	35 kg	45 kg	45 kg	kg	RENK COLORS	FİYAT TL/Ad
		400x548x68	400x548x143	400x548x218			
8241 32 1005	5	1X	4X	--	59		3850,35
8241 32 1006	6	4X	1X	1X	62	RAL 7035	4160,70
8241 32 1007	7	5X	2X	--	65	RAL 3020	4916,90
8241 32 1008	8	7X	1X	--	67		5241,15
8241 32 2005	5	1X	4X	--	59		3850,35
8241 32 2006	6	4X	1X	1X	62	RAL 7035	4160,70
8241 32 2007	7	5X	2X	--	65	RAL 5003	4916,90
8241 32 2008	8	7X	1X	--	67		5241,15
8241 32 3005	5	1X	4X	--	59		3850,35
8241 32 3006	6	4X	1X	1X	62	RAL 7035	4160,70
8241 32 3007	7	5X	2X	--	65	RAL 7016	4916,90
8241 32 3008	8	7X	1X	--	67		5241,15
8241 00 1209 Dolu/Full 206 Parça/Pcs	8	7X	1X	--			11918,30

(*) İşaretili olan ürünler stoklarla sınırlıdır.
Limited with stocks.

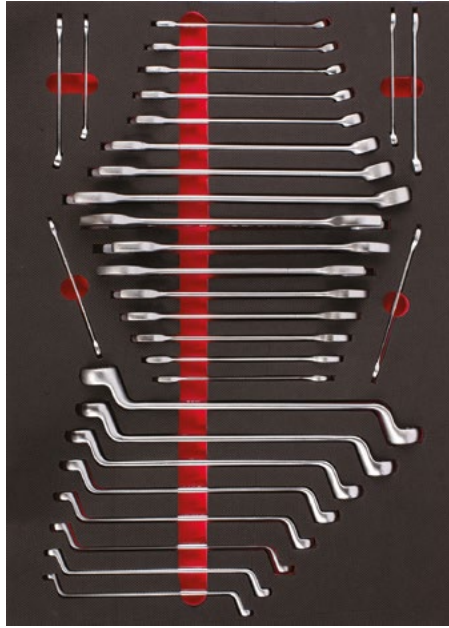

1. Pro Seri Çekmece/Drawer

Kod / Code 8241001030

KOD CODE	İÇERİK CONTENTS	□	FİYAT TL/Ad
0130	İki Ağız Anahtar Uzun Boy / D/E Open Jaw Wrench Long Pattern 6x7 - 8x9 - 10x11 - 12x13 14x15 - 16x17 - 18x19 - 20x22 21x23 - 24x26	10	
0330	Kombine Anahtar Uzun Boy / Combination Wrench Long Pattern 6 - 7 - 8 - 9 - 10 - 11 - 12 - 13 14 - 17 - 19 - 22	12	905,60
0430	Yıldız Anahtar / D/E Ring Wrench 6x7 - 8x9 - 10x11 - 12x13 14x15 - 16x17 18x19 - 20x22	8	



2. Pro Seri Çekmece/Drawer

Kod / Code 8241002072

KOD CODE	İÇERİK CONTENTS	□	FİYAT TL/Ad
1107	1/4" Altı Köşe Lokma Takımı / 1/4" Socket Wrench Set 4 - 5 - 6 7 - 8 - 9 - 10 11 - 12 - 13 Altı Köşe Six Point 1/4" Cırcır kolu / 1/4" Ratchet Handle 1/4" Mafsallı / 1/4" Universal Joint 1/4" T Kol / 1/4" Sliding T Handle	15	
1113	1/4" Ara Kol / 1/4" Extension Bar 50-100 mm 1/2" Lokma Takımı / 1/2" Socket Wrench Set 1/2" Cırcır Kolu 32 Diş / 1/2" Ratchet Handle 1/2" Mafsallı / 1/2" Universal Joint 1/2" T Kol Adaptör / 1/2" Sliding T Handle Adapter	24	1756,30
1113	1/2" Ara Kol / 1/2" Extension Bar 125-250 mm		
1113	1/2" Lokmalı Allen Uçlar / 1/2" Hexagonal Bits Sockets H5-H6-H7-H8-H10-H12-H14	7	
1113	1/2" Lokmalı Star Uç / 1/2" Star Bits Socket T20-T25-T27-T30-T40-T45-T50-T55-T60	9	
0330	Kombine Anahtar Uzun Boy / Combination Wrench Long 16-18	2	
4900	Allen Takımı 6 Köşe / Hex Key Wrench Set 2-2.5-3-3.5-4-5-6-7-8-9-10-12	12	



3. Pro Seri Çekmece/Drawer

Kod / Code 8241003051

KOD CODE	İÇERİK CONTENTS	□	FİYAT TL/Ad
07415	Sıralı Tel Fırça 3 Sıralı / Hand Brush 3 Raws	1	
6350	Levye Oluklu / Tyre Lever 400 mm	1	
6220	Spiralli Mıknatıs / Flexible Magnet Holder 500 gr	1	
4110	Düz Topaç Tornavida / Screwdriver , Stubby, Flat 6.5x25	1	
4130	Yıldız Topaç Tornavida / Screwdriver , Stubby, Phillips 6x25	1	808,50
4770	Lokma Uçlu Tornavida / Nutspinner 6-7-8-9-10-13	6	
4780	Manyetik Bits Tutucu Tornavida / Screwdriver, Magnetic Bit Holder 6.3x120	1	
4905	Yuvarlak Başlı Allen Takımı / Hexkey Wrench Ballpoint Set 2-2.5-3-4-5-6-8-10	8	
4800	Bits Set Takım (Plastik Kutulu) / Bits Set in Plastic Case	31	



4. Pro Seri Çekmece/Drawer

Kod / Code 8241004027

KOD CODE	İÇERİK CONTENTS	☐	FİYAT TL/Ad
0340	Cırcır Kombine Anahtar / Combination Wrench With Ratchet 10-13-17-19	4	
4909	T Tipi Torx Allen Anahtar / Torx Allen Key T type T9-T10-T15-T20-T25-T27-T30-T40	8	
1108	1/2" Altı Köşe Derin Lokma / 1/2" Deep Socket Wrench, six points 10-11-12-13-14-15-16-17-18-19	10	1338,75
1113	1/2" Altı Köşe Havalı Lokma / 1/2" Impact Socket Wrench 13-17-18-19-24	5	



5. Pro Seri Çekmece/Drawer

Kod / Code 8241005010

KOD CODE	İÇERİK CONTENTS	☐	FİYAT TL/Ad
3331	İç Eğri Segman Pense / Circlip Pliers, Internal, Bent 170 mm	1	
3321	İç Düz Segman Pense / Circlip Pliers, Internal, Flat 180 mm	1	
3311	Dış Eğri Segman Pense / Circlip Pliers, External, Bent 170 mm	1	
3301	Dış Düz Segman Pense / Circlip Pliers, External, Flat 180 mm	1	
3700	Yan Keski Opak İzole / Side Cutting Pliers, 160 mm	1	1211,05
3220	Düz Kargaburun Opak İzole / Nose Pliers, 200 mm	1	
3020	Kombine Pense Opak İzole / Combination Pliers, 180 mm	1	
2510	Special Ayarlı Pense / Special Grip 250 mm	1	
0600	Kurbağacık Anahtar / Adjustable Jaw Wrench 10"	1	
2400	Üniversal Fort Pense / Universal Grip 240 mm	1	



6. Pro Seri Çekmece/Drawer

Kod / Code 8241006018

KOD CODE	İÇERİK CONTENTS	☐	FİYAT TL/Ad
4300	Opak Seri Düz Uçlu Tornavida / Opak Screwdriver, Flat 4x100-5x125-6x150-8x175	4	
4320	Opak Seri Yıldız Uçlu Tornavida / Opak Screwdriver, Phillips 4.5x80-6x100	2	
5800	Tesviyeci Çekiç / Mechanist Hammer 300 gr	1	
5850	Plastik Çekiç / Plastic Hammer ø30	1	656,95
5545	Konik Pim Zimba / Drift Punch 5 mm	1	
5550	Düz Pim Zimba / Split Pin Punch 5 mm	1	
5540	Nokta Zimba / Center Punch 5x120	1	
5500	Düz Keski / Flat Cold Chisel 150 mm	1	
4920	T Tipi Allen Anahtar / T Type Hex Key Wrench 3-4-5-6-7-8	6	



8242 GARAJ SERİSİ / GARAGE SERIES

Garaj Serisi Takım Dolabı (5-6-7-8 Çekmeceli)
Garage Series Workshop Trolley (5-6-7-8 Drawers)

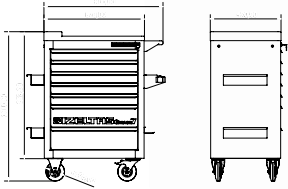

Ölçü/Size: 470x670x1010 mm

Sacdan imal edilmiş, Fırın boya
Made of sheet metal, Electrostatic paint



KOD/CODE	ÇEKMECE DRAWERS	35 kg	45 kg	45 kg	kg	RENK COLORS	FİYAT TL/Ad
		400x548x68	400x548x143	400x548x218			
8242 32 1005	5	1X	4X	--	59		3440,40
8242 32 1006	6	4X	1X	1X	62	RAL 7016 RAL 3020	4049,60
8242 32 1007	7	5X	2X	--	65		4731,50
8242 32 1008	8	7X	1X	--	67		5194,10
8242 32 2005	5	1X	4X	--	59		3440,40
8242 32 2006	6	4X	1X	1X	62	RAL 7016 RAL 5003	4049,60
8242 32 2007	7	5X	2X	--	65		4731,50
8242 32 2008	8	7X	1X	--	67		5194,10
8242 32 3005	5	1X	4X	--	59		3440,40
8242 32 3006	6	4X	1X	1X	62	RAL 7016 RAL 7035	4049,60
8242 32 3007	7	5X	2X	--	65		4731,50
8242 32 3008	8	7X	1X	--	67		5194,10
8242 00 1142	7	5X	2X	--			9780,60
8242 00 8142	8	7X	1X	--			10243,20

✓ Ergonomik sap
● Ergonomic handle



✓ 8 Bölmeli, sağlam ABS tabla
● Durable ABS worktop with divisions



✓ Havluluk x1
Avadanlık x2 Askılık x1
● Paper Roll Holder x1
Bottle & Tins Holder x2 Hanger x1



✓ %100 açılabilir teleskobik raylar
● %100 extendable telescopic slides

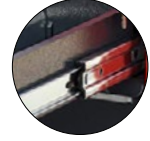

✓ Merkezi kilit sistemi, mandal sistemi devrilme emniyet sistemi.
● Central locking, system handgrip lock system antitilt system



✓ 2 sabit, 2 hareketli frenli tekerlek Ø 125mm
● 2 swivel castors with brake 2 fixed castors Ø 125 mm



✓ Yüksek dayanımlı elektrostatik toz boya.
● High strength electrostatic powder coating



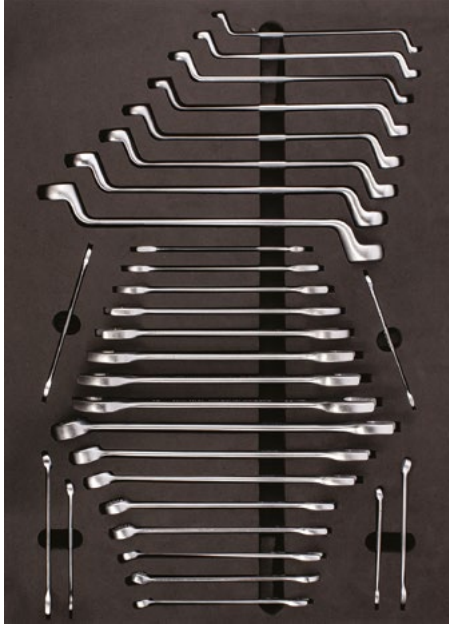

1. Garaj Seri Çekmece/Drawer

Kod / Code 8242001030

KOD CODE	İÇERİK CONTENTS	☐	FİYAT TL/Ad
0130	İki Ağız Anahtar Uzun Boy D/E Open Jaw Wrench Long Pattern 6x7 - 8x9 - 10x11 - 12x13 14x15 - 16x17 - 18x19 - 20x22 - 21x23 - 24x26	10	
0330	Kombine Anahtar Uzun Boy Combination Wrenches Long Pattern 6 - 7 - 8 - 9 - 10 - 11 - 12 - 13 - 14 - 17 - 19 - 22	12	905,60
0430	Yıldız Anahtar Ring Wrench 6x7 - 8x9 - 10x11 - 12x13 - 14x15 - 16x17 18x19 - 20x22	8	

2. Garaj Seri Çekmece/Drawer

Kod / Code 8242002072



KOD CODE	İÇERİK CONTENTS	☐	FİYAT TL/Ad
1113	1/2" Lokmalı Allen Uçlar Hexagonal Bits Socket H5-H6-H7-H8-H10-H12-H14	7	
1113	1/2" Lokmalı Star Uç / 1/2 Star Bits Socket T20-T25-T27-T30-T40-T45-T50-T55-T60	9	
0330	Kombine Anahtar Uzun Boy Combination Pliers Long 16-18	2	
4900	Allen Takımı Altı Köşe / Hex Key Wrench Set 2-2.5-3-3.5-4-5-6-7-8-9-10-12	12	
1107	1/4" Altı Köşe Lokma Takımı Socket Wrench Set 4 - 5 - 6 7 - 8 - 9 - 10 11 - 12 - 13 Altı Köşe Six Points	15	1756,30
	1/4" Cırcır Kolu Ratchet Handle		
	1/4" Mafsal Universal Joint		
	1/4" T Kol / Sliding T Handle		
	1/4" Ara Kol / Extension Bar 50 -100 mm		
1113	1/2" Lokma Takımı Socket Wrench Set 10 - 11 - 12 13 - 14 - 15 16 - 17 - 18 19 - 21 - 22 23 - 24 - 26 27 - 28 - 30 32 Altı Köşe Six Points	24	
	1/2" Cırcır Kolu 32 Diş Ratchet Handle		
	1/2" Mafsal Universal Joint		
	1/2" T Kol Adaptör Sliding T Handle Adapter		
	1/2" Ara Kol Extension Bar 125-250 mm		

3. Garaj Seri Çekmece/Drawer

Kod / Code 8242003010

KOD CODE	İÇERİK CONTENTS	☐	FİYAT TL/Ad
3331	İç Eğri Segman Pense Circlip Pliers Internal (Bent) 170 mm	1	1211,05
3321	İç Düz Segman Pense Circlip Pliers Internal (Flat) 180 mm	1	
3311	Dış Eğri Segman Pense Circlip Pliers External (Bent) 170 mm	1	
3301	Dış Düz Segman Pense Circlip Pliers External (Flat) 180 mm	1	
3700	Yan Keski Opak Seri Side Cutting Pliers 160 mm	1	
3220	Düz Kargaburun Opak Seri Nose Pliers (Flat) 200 mm	1	
3020	Kombine Pense Opak Seri Combination Pliers 180 mm	1	
2510	Special Ayarlı Pense / Universal Grip 250 mm	1	
0600	Kurbağacık Anahtar / Adjustable Wrench 10"	1	
2400	Üniversal Fort Pense / Waterpump Pliers Üniversal 240 mm	1	

4. Garaj Seri Çekmece/Drawer

Kod / Code 8242004018

KOD CODE	İÇERİK CONTENTS	☐	FİYAT TL/Ad
4300	Opak Seri Düz Uçlu Tornavida Screwdriver, Opak Flat 4x100-5x125-6x150-8x175	4	656,95
4320	Opak Seri Yıldız Uçlu Tornavida Screwdriver, Opak Philips 4.5x80-6x100	2	
5800	Tesviyeci Çekiç Machinist's Hammer 300 gr	1	
5850	Plastik Çekiç Plastic Hammer ø30	1	
5545	Konik Pim Zimba Drift Punch 5 mm	1	
5550	Düz Pim Zimba Split Pin Punch 5 mm	1	
5540	Nokta Zimba Center Punch 5x120	1	
5500	Düz Keski Flat Cold Chisel 150 mm	1	
4920	T Tipi Allen Anahtar / Hex Key Wrench 3-4-5-6-7-8	6	

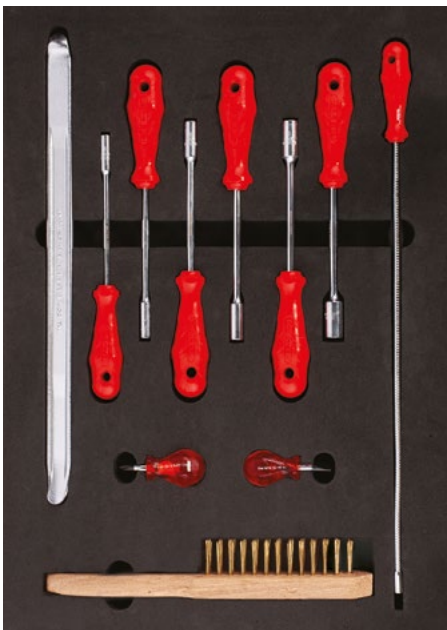
5. Garaj Seri Çekmece/Drawer

Kod / Code 8242005011

KOD CODE	İÇERİK CONTENTS	☐	FİYAT TL/Ad
07415	Sıralı Tel Fırça 3 Sıralı Hand Brush 3 Raws	1	519,20
6350	Levye Oluklu Tyre Lever, Straight 400 mm	1	
6220	Spiralli Miknatis Flexible Magnet Holder 500 gr	1	
4110	Düz Topaç Tornavida Screwdriver Stubby Flat 6.5x25	1	
4130	Yıldız Topaç Tornavida Screwdriver Stubby Phillips 6x25	1	
4770	Lokma Uçlu Tornavida Nut Spinner 6-7-8-9-10-13	6	



8235
PARTNER SERİSİ / PARTNER SERIES

Partner Mobil Takım Dolabı (5 Çekmeceli)
Partner Workshop Trolley (5 Drawers)



- ✓ Merkezi kilit sistemi ve mandal sistemi.
- Central lock system and handgrip lock system.



- ✓ Teleskobik rulmanlı kızaklar tüm çekmeceler %100 açılabilir.
- Telescopic slides which are %100 extendable.



- ✓ 8 Bölmeli, sağlam ABS tabla
- 8 Durable ABS worktop with divisions



- ✓ 2 sabit, 2 hareketli frenli tekerlek ø 100mm
- 2 swivel castors with brake
2 fixed castors ø 100 mm



- ✓ Yüksek dayanımlı elektrostatik toz boya.
- High strength electrostatic powder coating



Ölçü/Size: 470x670x975 mm

Sacdan imal edilmiş, Fırın boya
Made of sheet metal, Electrostatic paint

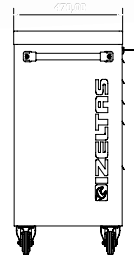
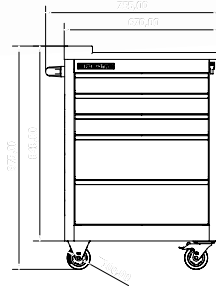







RAL 3020



RAL 5003



RAL 9005

KOD/CODE	ÇEKMECE DRAWERS	 400x550x75	 400x550x180	 kg	RENK COLORS	FİYAT TL/Ad
8235 32 6005	5	3X	2X	56	 RAL 3020	3130,10
8235 32 5005	5	3X	2X	56	 RAL 5003	3130,10
8235 32 7005	5	3X	2X	56	 RAL 9005	3130,10
8235 00 6121 Dolu/Full 118 Parça/Pcs	5	3X	2X			6842,45

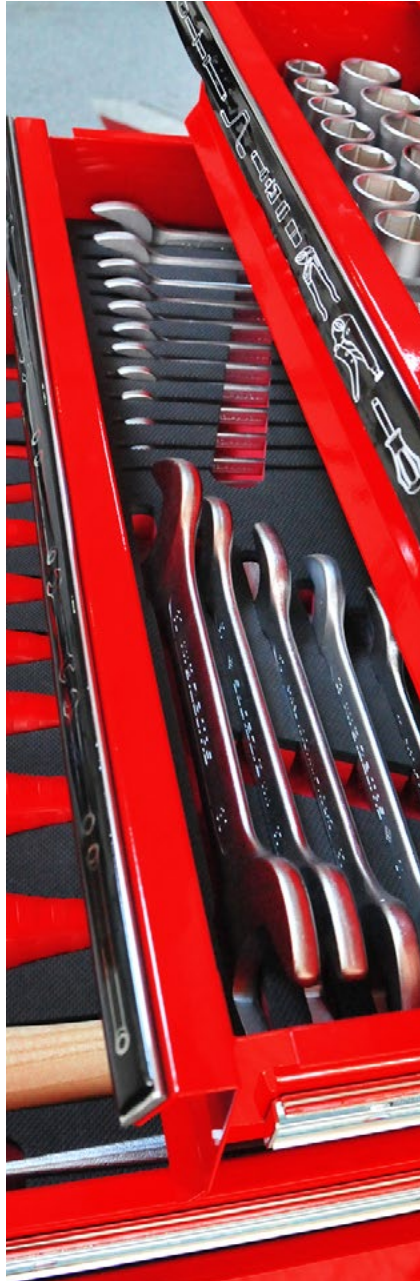

1. Partner Seri Çekmece/Drawer

Kod / Code 8235001072

KOD CODE	İÇERİK CONTENTS	□	FİYAT TL/Ad
1107	<p>1/4" Altı Köşe Lokma Takımı 1/4" Socket Wrench Set</p> <p>4 - 5 - 6 7 - 8 - 9 - 10 11 - 12 - 13 Altı Köşe Six Points</p>	15	
1113	<p>1/2" Cırcır kolu Ratchet Handle</p> <p>1/2" Mafsal Universal Joint</p> <p>1/2" T Kol Sliding T Handle</p> <p>1/2" Ara Kol Extention Bar 50-100 mm</p> <p>1/2" Lokma Takımı 1/2" Socket Set</p> <p>1/2" Cırcır Kolu 32 Diş Ratchet Handle</p> <p>1/2" Mafsal Universal Joint</p> <p>1/2" T Kol Adaptör Sliding T Handle Adapter</p> <p>1/2" Ara Kol Extention Bar 125-250 mm</p>	24	1967,40
1507	<p>1/4" Derin Lokma Tornavida Adaptörü Spindle Handle</p>	1	
4900	<p>12 'li Allen Anahtar Takımı Hex Key Wrench Set 2-2.5-3-3.5-4-5-6-7-8-9-10-12 mm</p>	12	
4910	<p>8 'li Torx Allen Anahtar Takımı Torx Key Wrench T9-T10-T15-T20-T25-T27-T30-T40</p>	8	
1108	<p>1/2" Altı Köşe Derin Lokma Deep Socket Wrench 6 Point 10-13-16-17-18-19 mm</p>	6	
1113	<p>1/2" 16 mm Buji Lokma Anahtar Spark Plug Socket With Rubber</p>	1	
2400	<p>240 mm Üniversal Fort Pense Waterpump Pliers, Universal</p>	1	
2500	<p>250 mm Üniversal Ayarlı Pense Universal Grip</p>	1	



2. Partner Seri Çekmece/Drawer

Kod / Code 8235002031

KOD CODE	İÇERİK CONTENTS	□	FİYAT TL/Ad
0100	İki Ağız Anahtar Kısa Boy Double Ended Open Jaw Wrench Short Pattern 6x7 - 8x9 - 10x11 - 12x13 14x15 - 16x17 - 18x19 - 20x22 21x23 - 24x26 - 25x28 - 30x32	12	
0320	Kombine Anahtar Kısa Boy Combination Wrench Short Pattern 8 - 9 - 10 - 11 - 12 - 13 14 - 15 - 16 - 17 - 19 - 22	12	898,10
0430	Yıldız Anahtar Ring Wrench 8x9 - 10x11 - 12x13 - 14x15 - 16x17 18x19 - 20x22	7	



3. Partner Seri Çekmece/Drawer

Kod / Code 8235003017

KOD CODE	İÇERİK CONTENTS	□	FİYAT TL/Ad
4300	Opak Seri Düz Uçlu Tornavida Screwdriver, Opak Flat 3x80-4x80-4x100-5x125-6x150	5	
4320	Opak Seri Yıldız Uçlu Tornavida Screwdriver, Opak Philips 4.5x80-6x100	2	
3700	Yan Keski Opak Seri Side Cutting Pliers 160 mm	1	
3020	Kombine Pense Opak Seri Combination Pliers 180 mm	1	846,85
3220	Düz Kargaburun Opak Seri Nose Pliers Flat 200 mm	1	
4770	Lokma Uçlu Tornavida Nut Spinner 6-7-8-10-13	5	
5500	Düz Keski Flat Cold Chisel 150 mm	1	
5800	Tesviyecı Çekiçi Machinist's Hammer 500 gr	1	



8243 EKO SERİSİ / ECO SERIES

Eko Serisi Takım Dolabı (5-7 Çekmeceli)
Eco Series Workshop Trolley (5-7 Drawers)



IZELTAS YOUTUBE

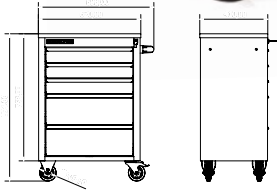

Ölçü/Size: 410x620x894 mm

✓ 4 bölmeli sağlam ve dayanıklı
ABS plastik üst malzeme tabla.
● Resistant and solid
top cover with 4 divisions



✓ %100 açılabilir teleskobik raylar.
● %100 extendable telescopic slides



✓ Merkezi kilit
● Central locking



✓ 2 sabit, 2 hareketli
frenli tekerlek ø 100 mm
● 2 swivel castors with brake
2 fixed castors ø 100 mm



✓ Yüksek dayanımlı elektrostatik toz boya.
● High strength electrostatic powder coating

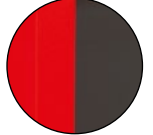

✓ Elokсалlı alüminyum tutma çantası.
● Handle with anodised aluminum

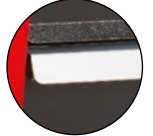

Sacdan imal edilmiş, Fırın boya
Made of sheet metal, Electrostatic paint



RAL 7016
RAL 3020



RAL 7016
RAL 5003



RAL 7035
RAL 7016

KOD/CODE	ÇEKMECE DRAWERS	35 kg	45 kg	Kg	RENK COLORS	FİYAT TL/Ad
8243 32 1005	5	3X	2X	43	RAL 7016 RAL 3020	2283,40
8243 32 1007	7	7X	--	43		3061,25
8243 32 2005	5	3X	2X	43	RAL 7016 RAL 5003	2283,40
8243 32 2007	7	7X	--	43		3061,25
8243 32 3005	5	3X	2X	43	RAL 7035 RAL 7016	2283,40
8243 32 3007	7	7X	--	43		3061,25
8243 00 1096 Dolu/Full 93 Parça/Pcs	5	3X	2X			5242,10
8243 00 7096 Dolu/Full 93 Parça/Pcs	7	7X	--			6019,95

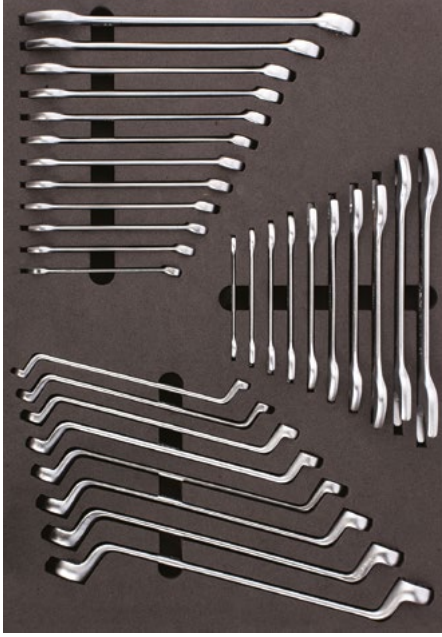
1. Eko Seri Çekmece/Drawer

Kod / Code 8243001030

KOD/CODE	İÇERİK CONTENTS	TL/Ad.
0100	İki Ağız Anahtar Kısa Boy D/E Open Jaw Wrench Short Pattern 6x7 - 8x9 - 10x11 - 12x13 14x15 - 16x17 - 18x19 - 20x22 - 21x23 - 24x26	10
0320	Kombine Anahtar Kısa Boy Combination Wrench Short Pattern 8 - 9 - 10 - 11 - 12 - 13 - 14 - 15 - 16 - 17 - 19 - 22	12
0430	Yıldız Anahtar Ring Wrench 6x7 - 8x9 - 10x11 - 12x13 - 14x15 - 16x17 18x19 - 20x22	8

2. Eko Seri Çekmece/Drawer

Kod / Code 8243002052

KOD/CODE	İÇERİK CONTENTS	TL/Ad.
1113	1113 1/2" 17'li Lokma Takımı Socket Wrench Set 1/2" mm 10 - 11 - 12 - 13 - 14 - 15 - 17 - 19 22 - 24 - 27 - 30 - 32 250 - 250 - 70	17
1107	1/4" Altı Köşe Lokma Takımı Socket Wrench Set 1/4" mm 4 - 5 - 6 - 7 - 8 - 9 - 10 - 11 - 12 - 13 140 - 115 - 100 - 50 - 38	15
4900	Allen Anahtar Takımı Hex Key Wrench Set 2 - 2.5 - 3 - 3.5 - 4 - 5 - 6 - 7 - 8 - 9 - 10 - 12	12
4770	Lokma Uçlu Tornavidalar Nutspinners 6 - 7 - 8 - 10 - 13	5

3. Eko Seri Çekmece/Drawer

Kod / Code 8243003013

KOD/CODE	İÇERİK CONTENTS	TL/Ad.
4320	Opak Seri Yıldız Uçlu Tornavida Opak Screwdriver, Phillips 4,5x80-6x100	2
4300	Opak Seri Düz Uçlu Tornavida Opak Screwdriver, Flat 4x100-5x125-6x150-8x175	4
3700	Yan Keski Opak Seri Side Cutting Pliers 160 mm	1
3020	Kombine Pense Opak Seri Combination Pliers 180 mm	1
3220	Kargaburun Düz Uçlu Opak Seri Nose Pliers, Flat 160 mm	1
5500	Düz Keski Krom Flat Cold Chisel 150 mm	1
5800	Tesviyeci Çekici Machinist's Hammer 300 gr	1
2510	Spesiyel Ayarlı Pense / Waterpump Pliers Special 250 mm	1
2400	Üniversal Fort Pense / Universal Grip 240 mm	1

Trend Serisi Takım Dolabı (5-7 Çekmeceli) Trend Series Workshop Trolley (5-7 Drawers)



✓ 4 bölmeli sağlam ve dayanıklı ABS plastik üst malzeme tabla.
● Resistant and solid top cover with 4 divisions



✓ %100 açılabilir teleskopik raylar.
● %100 extendable telescopic slides

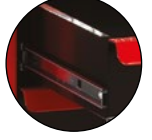

✓ Merkezi kilit
● Central locking



✓ 2 sabit, 2 hareketli frenli tekerlek ø 100 mm
● 2 swivel castors with brake
2 fixed castors ø 100 mm



✓ Yüksek dayanımlı elektrostatik toz boya
● High strength electrostatic powder coating



✓ Kendiliğinden açılmayı engelleyen plastik kilit
● Plastic lock preventing self opening





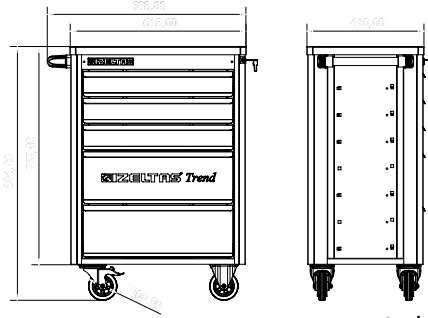

Ölçü/Size: 410x618x894 mm



İZELTAS YOUTUBE

Sacdan imal edilmiş, Fırın boya
Made of sheet metal, Electrostatic paint

KOD/CODE	ÇEKMECE DRAWERS	 30 kg	 30 kg	 Kg	RENK COLORS	FİYAT TL/Ad
		350x503x82	350x503x176			
8244 32 1005	5	3X	2X	43		2292,60
8244 32 1007	7	7X	--	43		2387,10
8244 00 5096 Dolu/Full 93 Parça/Pcs	5	3X	2X			5251,30
8244 00 7096 Dolu/Full 93 Parça/Pcs	7	7X	--			5345,80

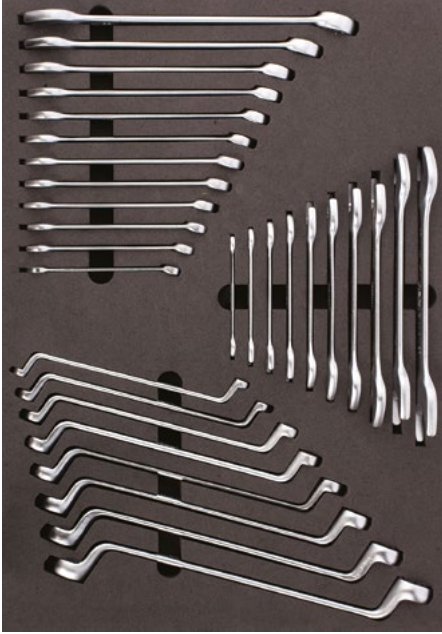
1. Trend Seri Çekmece/Drawer Kod / Code 8244001030

KOD/CODE	İÇERİK CONTENTS	☐	TL/Ad.
0100	İki Ağız Anahtar Kısa Boy D/E Open Jaw Wrench Short Pattern 6x7 - 8x9 - 10x11 - 12x13 14x15 - 16x17 - 18x19 - 20x22 - 21x23 - 24x26	10	
0320	Kombine Anahtar Kısa Boy Combination Wrench Short Pattern 8 - 9 - 10 - 11 - 12 - 13 - 14 - 15 - 16 - 17 - 19 - 22	12	849,80
0430	Yıldız Anahtar Ring Wrench 6x7 - 8x9 - 10x11 - 12x13 - 14x15 - 16x17 18x19 - 20x22	8	



2. Trend Seri Çekmece/Drawer Kod / Code 8244002052

KOD/CODE	İÇERİK CONTENTS	☐	TL/Ad.
1113	1/2" 17'li Lokma Takımı Socket Wrench Set 1/2" mm 10 - 11 - 12 - 13 - 14 - 15 - 17 - 19 22 - 24 - 27 - 30 - 32 250 - 250 - 70	17	
1107	1/4" Altı Köşe Lokma Takımı Socket Wrench Set 1/4" mm 4 - 5 - 6 - 7 - 8 - 9 - 10 - 11 - 12 - 13 140 - 115 - 100 - 50 - 38	15	1226,00
4900	Allen Anahtar Takımı Hex Key Wrench Set 2 - 2.5 - 3 - 3.5 - 4 - 5 - 6 - 7 - 8 - 9 - 10 - 12	12	
4770	Lokma Uçlu Tornavidalar Nutspinners 6 - 7 - 8 - 10 - 13	5	

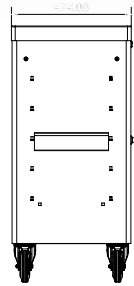
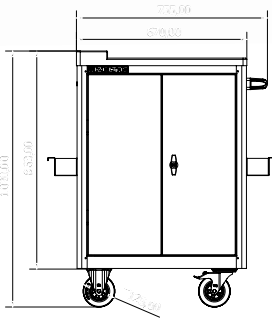

3. Trend Seri Çekmece/Drawer Kod / Code 8244003013

KOD/CODE	İÇERİK CONTENTS	☐	TL/Ad.
4320	Opak Seri Yıldız Uçlu Tornavida Opak Screwdriver, Phillips 4.5x80-6x100	2	
4300	Opak Seri Düz Uçlu Tornavida Opak Screwdriver, Flat 4x100-5x125-6x150-8x175	4	
3700	Yan Keski Opak Seri Side Cutting Pliers 160 mm	1	
3020	Kombine Pense Opak Seri Combination Pliers 180 mm	1	882,90
3220	Kargaburun Düz Uçlu Opak Seri Nose Pliers, Flat 160 mm	1	
5500	Düz Keski Krom Flat Cold Chisel 150 mm	1	
5800	Tesviyeci Çekici Machinist Hammer 300 gr	1	
2510	Special Ayarlı Pense / Waterpump Pliers Special 250 mm	1	
2400	Üniversal Fort Pense / Universal Grip 240 mm	1	

Vagon Serisi Takım Dolabı Wagon Series Workshop Trolley

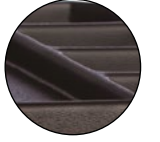

- ✓ 8 Bölmeli, sağlam ABS tabla
- Durable ABS worktop with divisions



- ✓ Kilit T kol
- Locked T-handle



- ✓ 2 Sabit, 2 hareketli frenli tekerlek ø 125mm
- 2 swivel castors with brake 2 fixed castors ø 125 mm



- ✓ Yüksek dayanımlı elektrostatik toz boya.
- High strength electrostatic powder coating

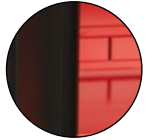

- ✓ 2X ayarlanabilir raf (10 adet seperatör ile)
- 2x adaptable shelves with separator 10 pcs



- ✓ Standard tutma sapı
- Standard handle



- ✓ 2X avadanlık
- 2X tin holder



Ölçü/Size: 474x670x1020 mm

Sacdan imal edilmiş, Fırın boya
Made of sheet metal, Electrostatic paint

RAL 7016
RAL 3020

KOD/CODE	Ölçü / SIZE (mm)	KG	RENK COLORS	FİYAT TL/AD
----------	------------------	----	-------------	-------------

8210 32 6001

474x670x1020

45

RAL 7016
RAL 3020

2130,85

8160
Takım Dolabı
Tool Cabinet

- ✓ Kilit T kol
- Locked T-handle



- ✓ %100 açılabilir teleskobik raylar.
- %100 extendable telescopic slides



- ✓ 2 hareketli frenli tekerlek ø 50mm
- 2 swivel castors with brake ø 50 mm



- ✓ Yüksek dayanımlı elektrostatik toz boya.
- High strength electrostatic powder coating



- ✓ Avadanlık x2
- Bottle and tins holder x2



- ✓ Askılık x4
- Hanger x4



- ✓ Özel askılık x4
- Special hanger x4



- ✓ Anahtar askısı x1
- Hanger for wrenches x1

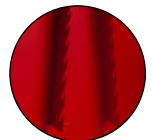

- ✓ Özel avadanlık x1
- Special tin holder x1

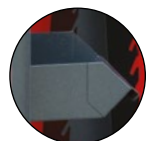

- ✓ Matkap ucu tutucu x1
- Drill bits holder x1

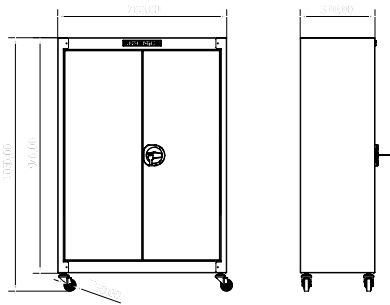
Ölçü/Size: 310x700x1050 mm
Sacdan imal edilmiş, Fırın boya
Made of sheet metal, Electrostatic paint

 RAL 7016
RAL 3020

KOD/CODE	20 kg	Ölçü / SIZE (mm)	KG	COLORS	FİYAT TL/Ad.
228x567x58					

8160 32 6001

3x

310x700x1050

35

 RAL 7016
RAL 3020

1633,50

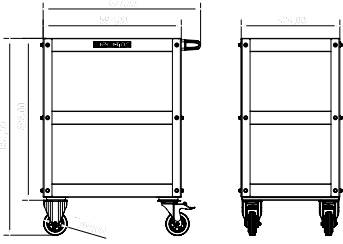
Demonte Mini Servis Arabası
Disassembled Mini Service Trolley

- **3X Kauçuk Kaydırmaz Mat**
3X Rubber Anti Slipping Mats
- **2X Sabit, 2X Hareketli Frenli Tekerlek (ø 100 mm)**
2X Fixed, 2X Swivel Castors with Brake (ø 100 mm)
- **Sağlam sac metal yapı, Her raf 50 Kg taşır.**
Robust sheet-steel construction, Loading capacity per shelf 50 Kg



Çelik konstrüksiyon
Steel construction

KOD/CODE	 420x590x57	Ölçü / SIZE (mm)	 KG	COLORS	FİYAT TL/Ad.
----------	---	------------------	---	--------	-----------------

8550 34 8001

3X

424x594x851

18

RAL 9005
RAL 3020

958,20

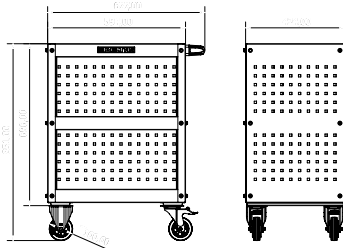
Demonte Mini Servis Arabası (kapalı)
Disassembled Mini Service Trolley (closed)

- **3X Kauçuk Kaydırmaz Mat**
3X Rubber Anti Slipping Mats
- **2X Sabit, 2X Hareketli Frenli Tekerlek (ø 100 mm)**
2X Fixed, 2X Swivel Castors with Brake (ø 100 mm)
- **Sağlam sac metal yapı, Her raf 50 Kg taşır.**
Robust sheet-steel construction, Loading capacity per shelf 50 Kg
- **Arabanın yanları ve arkasında kare askı delikleri**
Square-shaped perforation on the side panels and back panel offers individual fastening



Çelik konstrüksiyon
Steel construction

KOD/CODE	 420x590x57	Ölçü / SIZE (mm)	 KG	COLORS	FİYAT TL/Ad.
----------	---	------------------	---	--------	-----------------

8550 34 8002

3X

424x594x851

23

RAL 9005
RAL 3020

1105,00

8545

Taşıma Arabası Platform Wagon

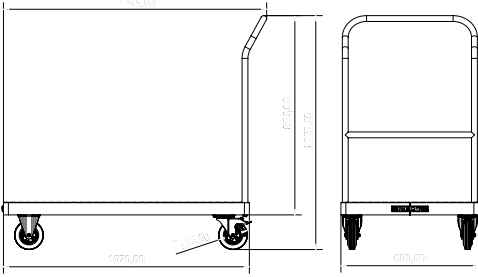

- **18mm Plywood Tabla (Kauçuk Mat ile Birlikte)**
18mm PLYWOOD table (with rubber mat)
- **2X Sabit, 2X Hareketli Frenli Tekerlek (ø 125mm)**
2X Fixed, 2X Swivel Castors with Brake (ø 125mm)
- **Sağlam sac metal yapı, Her raf 310 Kg taşır.**
Robust sheet-steel construction, Loading capacity per shelf 310 Kg

Çelik konstrüksiyon
Steel construction

KOD/CODE	Ölçü / SIZE (mm)	KG	COLORS	FIYAT TL/Ad.
----------	------------------	----	--------	--------------

8545 34 1005

600x1145x1025

38

RAL 9005

2111,30

8550

Servis Arabası (Büyük Boy) Service Trolley (Large Size)

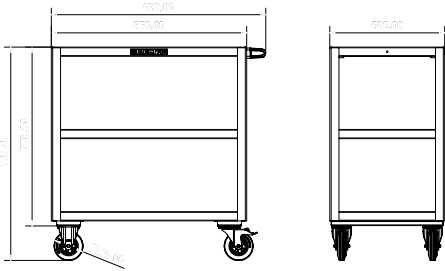

- **3X Kauçuk Kaydırmaz Mat**
3X Rubber Anti Slipping Mats
- **2X Sabit, 2X Hareketli Frenli Tekerlek (ø 125 mm)**
2X Fixed, 2X Swivel Castors with Brake (ø 125 mm)
- **Sağlam sac metal yapı, Her raf 75 Kg taşır.**
Robust sheet-steel construction, Loading capacity per shelf 75 Kg

Çelik konstrüksiyon
Steel construction

KOD/CODE	Ölçü / SIZE (mm)	KG	COLORS	FIYAT TL/Ad.
----------	------------------	----	--------	--------------



494x844x40

8550 34 6001

3X

500x850x935

37

RAL 3020

1497,70

Servis Masası (Panolu) Work Bench (With Panel)

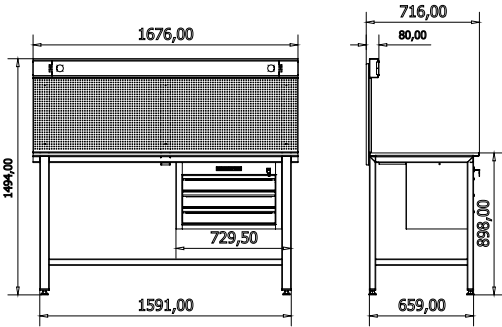

- **Merkezi kilit sistemi, mandal sistemi**
Central locking system, handgrip lock system
- **Kaynaklı sağlam tasarım**
Robust welded design
- **%100 Açılabilir teleskobik raylar**
100% extendable telescopic slides
- **Yüksek dayanımlı elektrostatik toz boya.**
High strength electrostatic powder paint
- **Delikli panel (220 V prizler ile).**
Perforated panel with electrical plugs 220 V

Çelik Konstrüksiyon ve zor koşullarda çalışmaya elverişli
Özel Plywood ahşap tezgah
Strong and durable steel construction and Plywood bench

KOD/CODE		Ölçü / SIZE (mm)	 KG	COLORS	FİYAT TL/Ad.
----------	--	------------------	--	--------	--------------

8500 34 6001

3X

720x1680x1495

102

RAL 7016
RAL 3020

4550,00

Servis Masası (Panosuz) Work Bench (Without Panel)

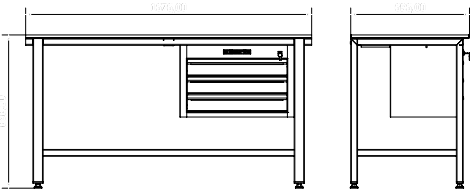

- **Merkezi kilit sistemi, mandal sistemi**
Central locking system, handgrip lock system
- **Kaynaklı sağlam tasarım**
Robust welded design
- **%100 Açılabilir teleskobik raylar**
100% extendable telescopic slides
- **Yüksek dayanımlı elektrostatik toz boya.**
High strength electrostatic powder paint

Çelik konstrüksiyon ve zor koşullarda çalışmaya elverişli
Özel Plywood ahşap tezgah
Strong and durable steel construction and Plywood bench

KOD/CODE		Ölçü / SIZE (mm)	 KG	COLORS	FİYAT TL/Ad.
----------	---	------------------	--	--------	--------------

8501 34 6001

3X

700x1680x900

84

RAL 7016
RAL 3020

3445,00

8502

Demonte Servis Masası
Disassembled Work Bench

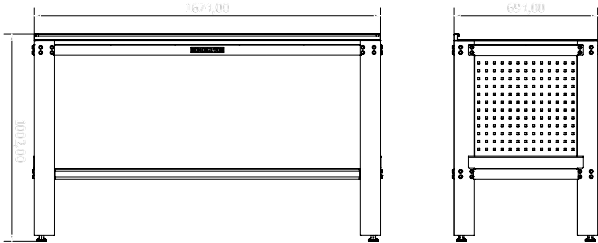

- **Demonte sağlam tasarım**
Robust disassembled design
- **18mm Plywood Tabla (Kauçuk mat ile birlikte)**
18mm Plywood Bench with non-slip rubber insert
- **Ayarlanabilir ayaklar**
Height adjustable feet
- **İZELTAS Eco ve/veya Trend Dolaplar ile kombine kullanabilme imkanı**
Can be combined with IZELTAS Eco and Trend Trolley

Çelik konstrüksiyon
Steel construction

KOD/CODE		Ölçü / SIZE (mm)	 KG	COLORS	FİYAT TL/Ad.
	200x500x55				

8502 34 6001

3X

694x1674x1002



35

RAL 3020

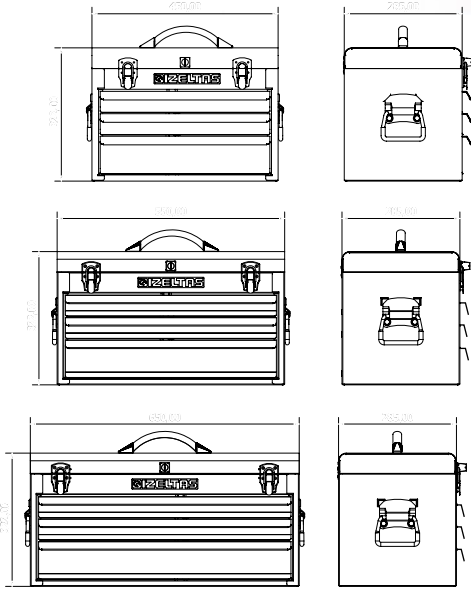
3289,00

Çekmeceli Alet Sandığı
Tool Chest With Drawers

Sacadan imal edilmiş, Fırın boya
Made from metal sheet, Electrostatic paint

KOD/CODE	Ölçü / SIZE (mm)	ÇEKMECE DRAWERS	 2x	 1x	 Kg	FİYAT TL/Ad
8320 33 1001	285x450x322	3X	238x370x47	238x370x87	16	1511,10
★8320 33 1002	285x550x322	3X	238x470x47	238x470x87	18	1527,20
8320 33 1003	285x650x322	3X	238x570x47	238x570x87	20	1543,20

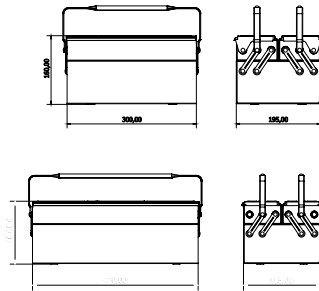
8410
Takım Çantası (3 Gözlü)
Tool Box (3 Trays)

Sacdan imal edilmiş, Fırın boya
Made from metal sheet, Electrostatic paint

KOD CODE	Ölçü / SIZE (mm)	g	1	FİYAT TL/Ad
8410 33 6103	195x300x160	2400	1	182,90
8410 33 6203	195x420x160	3000	1	218,65

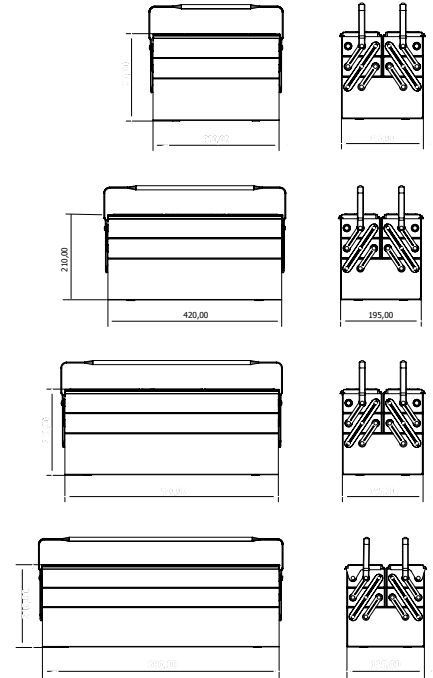
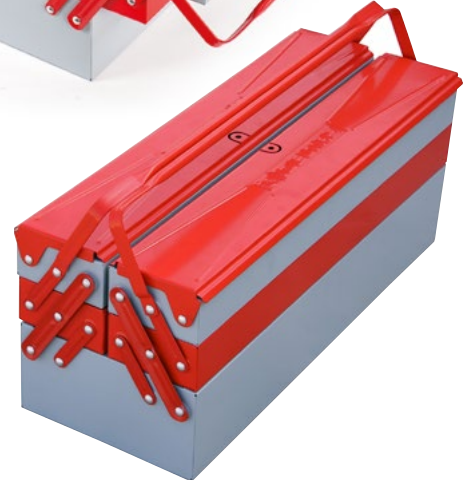
8420
Takım Çantası (5 Gözlü)
Tool Box (5 Trays)

Sacdan imal edilmiş, Fırın boya
Made from metal sheet, Electrostatic paint

KOD CODE	Ölçü / SIZE (mm)	g	1	FİYAT TL/Ad
8420 33 6105	195x300x210	3200	1	256,25
8420 33 6205	195x420x210	4200	1	266,05
8420 33 6305	195x520x210	5000	1	303,15
8420 33 6405	195x600x210	5600	1	408,40

(*) İşaretili olan ürünler stoklarla sınırlıdır.
Limited with stocks.

Takım Çantası (5 Gözlü)
Tool Box (5 Trays)**8420 00 5063****Mekanikçi Takım Çantası (62 Parça, 5 Gözlü)**
Tool Box for Mechanician (62 Pcs, 5 Trays)**8420 00 5046****Elektrikçi Takım Çantası (45 Parça, 5 Gözlü)**
Tool Box for Electrician (45 Pcs, 5 Trays)**8420 00 5028****Tesisatçı Takım Çantası (28 Parça, 5 Gözlü)**
Tool Box for Plumbers (28 Pcs, 5 Trays)

8420 00 5063
Mekanikçi Takım Çantası (5 Gözlü)
Tool Box for Mechanician (5 Trays)

KOD CODE	ÖLÇÜ SIZE mm	TL/Ad.
8420 00 5063	195x420x210 DOLU / FULL	62 1966,60

KOD CODE	İÇERİK CONTENTS	TL/Ad.
05881 50 015	5 m Krom Şerit Metre Chrom Case Steel, Measuring tapes	1
4785 19 6330	6.3x30 Kısa Bits Tutucu Tornavida Screwdriver, Magnetic Bit Holder (Short)	1
4800 00 8110	10 'Lu Bits Takım Bits Set 10 (Pcs) 25 mm	10
4320	Opak Seri Yıldız Uçlu Tornavida Screwdriver, Opak, Flat 4.5x80-6x100	2
4300	Opak Seri Düz Uçlu Tornavida Screwdriver, Opak, Philips 3x80-4x100-5x125-6x150	4
4550 17 0135	135mm Kontrol Kalem Voltage Tester	1
2400 11 0240	240mm Üniversal Fort Pense Water Pump Pliers Universal	1
1113	1/2" Lokma Anahtar Socket Wrench 10-11-12-13-14-15-17-19-22-24-27-30-32	13
1513 06 4250	1/2" Uzun Ara Kol Extension Bar Long 250 mm	1
1513 06 4070	1/2" Mafsalsal Universal Joint 70 mm	1
1513 06 0032	1/2" Cırcır Kol 32 Dişli Ratchet Handle 250 mm	1
4900 00 3112	12 'Li Allen Anahtar Takım 6 Köşe Hex Key Wrench Set 2-2.5-3-3.5-4-5-6-7-8-9-10-12	12
0320	Kısa Kombine Anahtar Combination Wrench Short Pattern 8-9-10-11-12-13-14-17-19-22	10
3700 16 2160	160mm Yan Keski Opak Seri Side Cutting Nippers, Opak insulated	1
3020 12 2180	180mm Kombine Pense Opak Seri Combination Pliers, Opak Insulated	1
3220 13 2160	160mm Düz Kargaburun Opak Seri Nose Pliers, Flat, Opak Insulated	1

8420 00 5046
Elektrikçi Takım Çantası (5 Gözlü)
Tool Box for Electrician (5 Trays)

KOD CODE	ÖLÇÜ SIZE mm	TL/Ad.
8420 00 5046	195x420x210 DOLU / FULL	45 2150,70

KOD CODE	İÇERİK CONTENTS	TL/Ad.
05881 50 005	5m Plastik Şerit Metre Plastic Measuring Tape	1
4783 19 6120	1000V İzoleli Manyetik Bits Tutucu Tornavida Screwdriver, Magnetic Bit Holder Insulated 6.3x120	1
4800 00 8106	6 'Lı Bits Takım Bits Set (6 Pcs)	6
0600 01 1010	10" Kurbağcık Anahtar Adjustable Jaw Wrench, PVC Insulated	1
4140-4145	1000V İzoleli Elektrikçi Düz, Yıldız Tornavida Insulated Electrician type Flat Screwdriver, Phillips 1000V 4x100-5.5x125 - 4.5x80-6x100	4
4550 17 0135	135mm Kontrol Kalem Voltage Tester	1
4550 17 0190	190mm Kontrol Kalem Voltage Tester	1
4773	1000V Süngüsü İzoleli Lokma Uçlu Tornavida Nut Spinner, Electrician Blade Insulated 1000V 6-7-8-10-13	5
0340	Cırcır Kombine Anahtar Combination Wrench With Ratchet 8-10-12-13-17-19	6
4900 00 3110	10 'Lu Allen Anahtar Takımı (mm) Hex Key Wrench Set 10 pcs 2-2.5-3-4-5-6-7-8-9-10	10
4500-4520	Klemens Tornavida Screwdriver, Electronic 3x80-3x100-3x125-3x60-4x80	5
3700 16 6160	1000V İzoleli Elektrikçi 160mm Yan Keski Insulated Electrician Type Side Cutter 1000V	1
3020 12 6180	1000V İzoleli Elektrikçi 180mm Kombine Pense Insulated Electrician Type Combination Plier 1000V	1
3220 13 6160	1000V İzoleli Elektrikçi 160mm Kargaburun Düz Insulated Electrician Type Nose Plier 1000V	1

8420 00 5028
Tesisatçı Takım Çantası (5 Gözlü)
Tool Box for Plumbers (5 Trays)

KOD CODE	ÖLÇÜ SIZE mm	TL/Ad.
8420 00 5028	195x420x210 DOLU / FULL	28 1931,85

KOD CODE	İÇERİK CONTENTS	TL/Ad.
0600 01 1010	10" Kurbağcık Anahtar 10" Adjustable Jaw Wrench, PVC Insulated	1
0600 01 1012	12" Kurbağcık Anahtar 12" Adjustable Jaw Wrench, PVC Insulated	1
2400 11 0240	240 Üniversal Fort Pense 240 Waterpump Pliers, Universal	1
2100 10 0012	12" Stilson Boru Anahtarı 12" Pipe Wrench, Stilson	1
4901 22 1270	1/2" Sae Allen Anahtar 1/2" Hex Key Wrench SAE	1
4300 17 6150	Opak Seri Düz Uçlu Tornavida Screwdriver, Opak, Slotted 6x150	1
4320 18 6100	Opak Seri Yıldız Uçlu Tornavida Screwdriver, Opak, Phillips 6x100	1
5800 25 0500	500gr Çekiç Machinist Hammer	1
5500 23 0200	200mm Düz Keski Flat Cold Chisel	1
3830 15 0250	250mm Betoncu Kerpeten Tower Pincers	1
4900 00 3112	12 'Li Allen Anahtar Takımı (mm) Hex Key Wrench Set 12 pcs 2-2.5-3-3.5-4-5-6-7-8-9-10-12	12
0588 15 0015	5m Krom Şerit Metre Chrom Case Steel Measuring Tape	1
2201 10 0010	1" Maşalı Boru Anahtarı 1" Pipe Wrench	1
3700 16 2160	160mm Yan Keski Opak Seri Side Cutting Nippers, Opak insulated	1
3020 12 2180	180mm Kombine Pense Opak Seri Combination Pliers, Opak Insulated	1
3220 13 2160	160mm Düz Kargaburun Opak Seri Nose Pliers, Flat, Opak Insulated	1

8440

Plastik Takım Çantaları
Plastic Tool Boxes



KOD CODE	inch	ÖLÇÜ SIZE mm	g	TL/Ad.
8440 33 1016	16"	413x212x186	1207	4 70,20
8440 33 1019	19"	480x267x242	1922	4 87,75
8440 33 1022	22"	564x310x310	2870	4 146,25

8445

Tekerlekli Plastik Takım Çantası
Plastic Mobile Tool Chest



KOD CODE	inch	ÖLÇÜ SIZE mm	g	TL/Ad.
8445 33 1028	28"	380x595x420	5900	1 345,15

8705 00 6113

Hobby Set Oto Tipi (13 Parça)
Hobby Set Auto Type (13 pcs)



KOD CODE	İÇERİK CONTENTS	TL/Ad.
0100	İki Ağz Anahtar (Kısa Boy) Duble Ended Open Jaw Wrench Short Pattern 8x9-10x11-12x13-14x15-16x17-18x19	6
1841	21 mm Kovan Anahtar Bir Ağz ve Mil Single Ended Tubular Socket Wench	1
2400	240 mm Ünsel Fort Pense Waterpump Pliers Universal	1
3020	160 mm Kombine Pense Opak Seri Combination Pliers	1
4240	Değişken Uçlu Tornavida Takımı Screwdriver Set Reversible 4.5x80 - 6x80	2
5800	200 gr Tesviyeci Çekiç / Machinist Hammer	1
6350	300 mm Levye Oluklu / Tyre Lever Straight	1

8790 00 8106

Bakım Onarım Seti (5 Parça)
Maintenance Set (5 Pcs)



KOD CODE	İÇERİK CONTENTS	TL/Ad.
3020 12 3160	160 mm Kombine Pense Kraft Seri Combination Pliers	1
3220 13 3160	160 mm Kargaburun Düz Uçlu Kraft Seri Nose Pliers Flat	1
3700 16 3140	140 mm Yan Keski Kraft Seri Side Cutting Pliers	1
4100 17 5100	5x100 Kraft Seri Düz Uçlu Tornavida Screwdriver Kraft, Flat	1
4120 18 4580	4.5x80 Kraft Seri Yıldız Uçlu Tornavida Screwdriver Kraft, Phillips	1

(*) İşaretili olan ürünler stoklarla sınırlıdır.
Limited with stocks.

8786 00 1003
Doğada Set (3 Parça)
Outdoor Set (3 Pcs)

8793 00 1014
Bakım Seti (14 Parça)
Maintenance Set (14 Pcs)

KOD CODE	İÇERİK CONTENTS	☐	TL/ Ad.
6710 27 0230	Bağ Makası Lüks / Pruning Shears	1	
6735 27 0300	Dal Budama Testeresi / Pruning Saw	1	557,55
6410 25 0800	Nacak / Hatchet	1	

KOD CODE	İÇERİK CONTENTS	☐	TL/Ad.
0130	İki Ağız Anahtar (Uzun Boy) Duble Ended Open Jaw Wrench Long Pattern 6x7-8x9-10x11-12x13-14x15-16x17-18x19-20x22	8	
3220	160 mm Kargaburun Düz Uçlu Ergonomik Seri Long Nose Pliers Flat	1	
3700	140 mm Yan Keski Ergonomik Seri Side Cutting Pliers	1	516,90
4350	Ergonomik Seri Düz Uçlu Tornavida 4x100-6x100 Screwdriver Ergonomic, Flat	2	
4370	Ergonomik Seri Yıldız Uçlu Tornavida 4.5x80-6x100 Screwdriver Ergonomic, Phillips	2	



**ŞABLON
BİLETT**

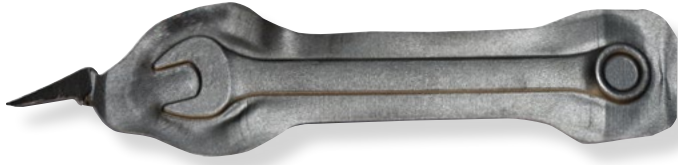

**FİNAL ÜRÜN
FINAL PRODUCT**

ANAHTARLAR

WRENCHES

İki Ağız Anahtarlar
Open Jaw Wrenches

Kombine Anahtarlar
Combination Wrenches

Yıldız Anahtarlar
Ring Wrenches

Çakma Anahtarlar
Slugging Wrenches

Kurbağacık Anahtarlar
Adjustable Wrenches

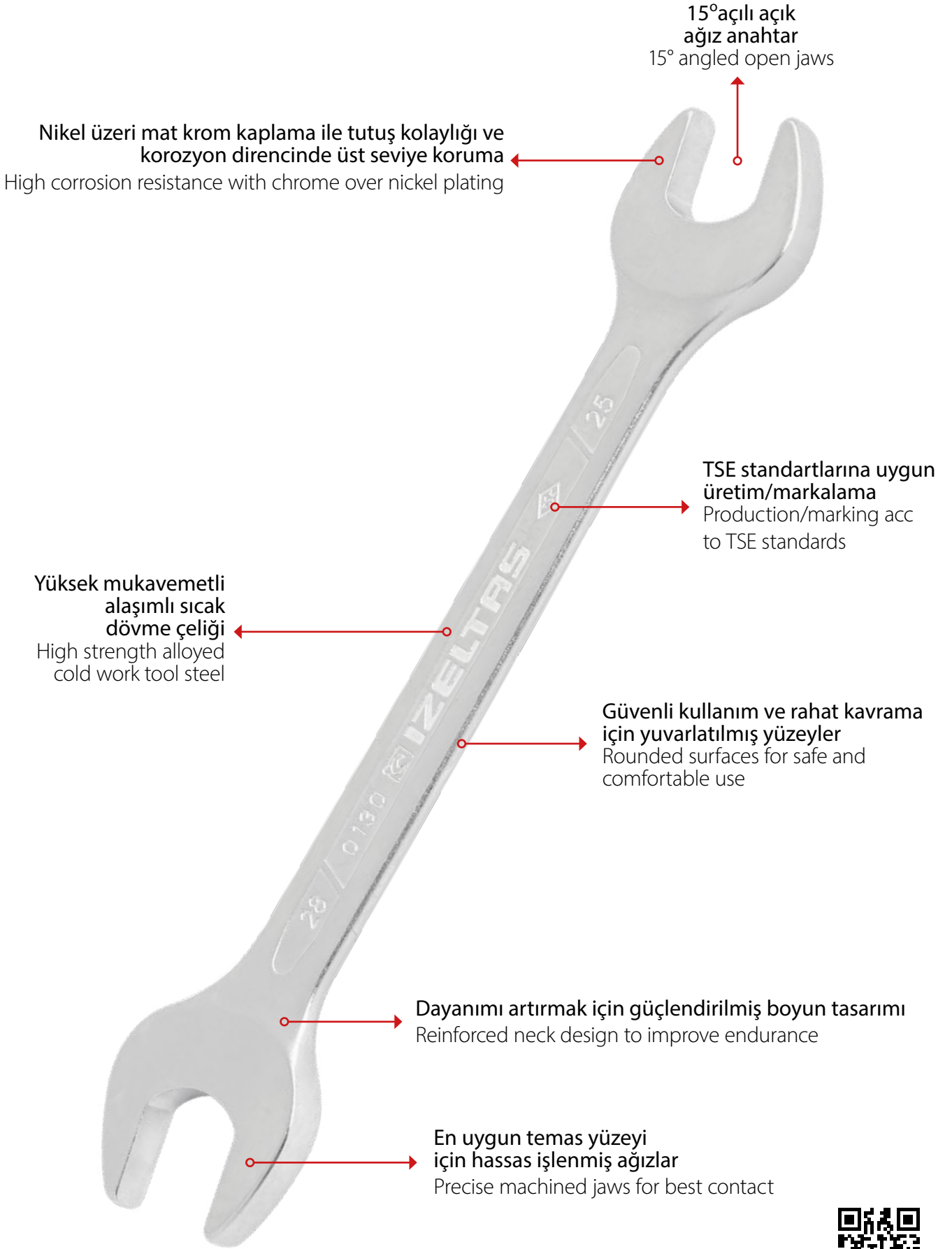

İKİ AĞIZ ANAHTAR / DOUBLE ENDED OPEN JAW WRENCH

İki Ağız Anahtar Kısa Boy (mm)
Double Ended Open Jaw Wrench Short Pattern (mm)

 TS 81-6
DIN 895

IZELTAS YOUTUBE

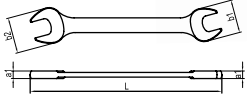
 Krom vanadyum, Krom kaplı
Chrom vanadium, Chrom plated

KOD CODE	mm	L mm	a1 mm	b1 mm	b2 mm	g		TL/Ad.
0100 01 0405	4x5	97	3.5	11	12.5	15	10	12,20
0100 01 0607	6x7	97	3.5	14	16	18	10	12,45
0100 01 0809	8x9	108	4	18	20	30	10	12,80
0100 01 0810	8x10	117	4.5	18	22	33	10	13,05
0100 01 1011	10x11	120	4.6	22	24	41	10	13,95
0100 01 1012	10x12	120	4.6	22	26	35	10	13,95
0100 01 1013	10x13	120	4.6	22	28	38	10	14,95
0100 01 1114	11x14	133	5.2	26	28	50	10	15,35
0100 01 1213	12x13	133	5.2	26	28	57	10	15,35
0100 01 1214	12x14	147	5.2	26	30	59	10	15,35
0100 01 1314	13x14	147	5.2	28	30	66	10	15,35
0100 01 1415	14x15	147	5.8	30	32	78	10	17,75
0100 01 1317	13x17	162	6.2	28	36	80	10	20,20
0100 01 1417	14x17	162	6.2	30	36	90	10	20,75
0100 01 1617	16x17	162	6.2	34	36	109	10	20,75
0100 01 1719	17x19	178	7	36	40	143	10	22,20
0100 01 1819	18x19	178	7	38	40	144	10	22,20
0100 01 1820	18x20	178	7	38	40	125	10	25,10
0100 01 1822	18x22	195	7.4	40	46	160	10	25,10
0100 01 1922	19x22	195	7.4	40	46	175	10	25,10
0100 01 2022	20x22	195	7.4	42	46	196	10	25,10
0100 01 2123	21x23	213	7.7	44	48	230	10	26,25
0100 01 2224	22x24	213	8	46	50	239	10	27,40
0100 01 2426	24x26	232	8.2	50	54	297	10	28,20
0100 01 2427	24x27	232	8.2	50	56	296	10	28,20
0100 01 2528	25x28	248	8.6	52	57.5	366	10	35,05
0100 01 2732	27x32	265	9	56	66	415	10	41,75
0100 01 3032	30x32	265	9	62	66	465	10	41,75

0100
İki Ağız Anahtar Takımı Kısa Boy (mm)
Double Ended Open Jaw Wrench Short Pattern Set (mm)

ÖZEL SERİLER (adet ve termin süresi isteyiniz)

0100 01 0608	6x8	97	3.5	14	18	20	10	12,45
0100 01 0708	7x8	108	3.5	16	18	20	10	12,80
0100 01 0709	7x9	108	4	16	20	25	10	12,80
0100 01 0910	9x10	117	4.6	20	22	30	10	13,05
0100 01 0911	9x11	120	4.6	20	24	30	10	13,95
0100 01 1014	10x14	120	5.2	22	30	50	10	14,95
0100 01 1113	11x13	133	5.2	26	28	50	10	15,35
0100 01 1315	13x15	147	5.2	28	30	65	10	17,75
0100 01 1722	17x22	195	7.4	36	46	160	10	25,10
0100 01 1924	19x24	213	7.7	40	50	200	10	26,25
0100 01 2226	22x26	232	8	46	54	250	10	28,20
0100 01 2227	22x27	232	8.2	46	56	260	10	28,20
0100 01 2430	24x30	265	9	50	62	370	10	41,75
0100 01 2730	27x30	265	9	56	62	380	10	41,75

KOD CODE	İÇERİK CONTENTS	g		TL/Ad.
0100 00 2108	6x7 - 8x9 - 10x11 12x13 - 14x15 - 16x17 18x19 - 20x22	736	8	140,35
0100 00 2112	6x7 - 8x9 - 10x11 12x13 - 14x15 - 16x17 18x19 - 20x22 - 21x23 24x26 - 25x28 - 30x32	2110	12	271,60

İki Ağız Anahtar Uzun Boy (mm)

Double Ended Open Jaw Wrench Long Pattern (mm)

TS ISO 10102
DIN 3110

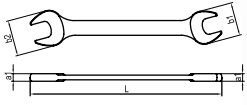

Krom vanadyum, Krom kaplı
Chrom vanadium, Chrom plated

KOD CODE	mm	L mm	a1 mm	b1 mm	b2 mm	g		TL/ Ad.
0130 01 0607	6x7	125	3.5	14	16	24	10	15,90
0130 01 0608	6x8	125	3.5	14	18	20	10	16,45
0130 01 0809	8x9	140	4	18	20	35	10	16,45
0130 01 0810	8x10	140	4	18	22	36	10	16,45
0130 01 1011	10x11	155	4.5	22	24	47	10	18,20
0130 01 1012	10x12	162	4.7	22	26	57	10	18,20
0130 01 1013	10x13	162	4.7	22	28	61	10	18,20
0130 01 1014	10x14	162	4.7	22	28	65	10	18,20
0130 01 1113	11x13	172	5	26	28	70	10	18,20
0130 01 1114	11x14	172	5	26	30	65	10	18,20
0130 01 1213	12x13	172	5	26	28	67	10	19,15
0130 01 1214	12x14	172	5	26	30	65	10	19,15
0130 01 1314	13x14	188	5.5	28	30	85	10	19,15
0130 01 1315	13x15	188	5.5	30	32	93	10	19,15
0130 01 1415	14x15	188	5.5	30	32	91	10	22,25
0130 01 1317	13x17	205	6.2	28	36	111	10	24,30
0130 01 1417	14x17	205	6.2	30	36	106	10	24,30
0130 01 1617	16x17	205	6.2	34	36	120	10	24,60
0130 01 1618	16x18	220	7	36	40	165	10	26,25
0130 01 1719	17x19	220	7	36	40	160	10	26,25
0130 01 1819	18x19	220	7	38	40	161	10	26,25
0130 01 1921	19x21	235	7.5	40	46	195	5	30,55
0130 01 1922	19x22	235	7.5	40	46	195	5	30,55
0130 01 2022	20x22	235	7.5	42	46	195	5	30,55
0130 01 1924	19x24	248	8.3	40	50	235	5	30,70
0130 01 2123	21x23	248	8.3	44	48	235	5	31,15
0130 01 2224	22x24	248	8.3	46	50	235	5	32,00
0130 01 2426	24x26	265	8.8	50	54	300	5	36,60
0130 01 2427	24x27	265	8.8	50	56	300	5	36,60
0130 01 2430	24x30	282	9.3	50	61.5	380	5	40,95
0130 01 2528	25x28	282	9.3	52	57.5	390	5	40,95
0130 01 2729	27x29	300	9.8	56	59	400	5	51,15
0130 01 2730	27x30	300	9.8	56	59	440	5	51,15
0130 01 2732	27x32	300	9.8	56	65.5	460	5	51,15
0130 01 3032	30x32	300	9.8	61.5	65.5	480	5	51,15
0130 01 3036	30x36	325	10.4	61.5	76	645	5	97,00
0130 01 3236	32x36	325	10.4	65.5	76	680	5	97,00
0130 01 3436	34x36	330	10.4	71	76	690	5	97,00
0130 01 3641	36x41	360	12	76	87	955	5	150,70
0130 01 4146	41x46	400	12.5	87	98	1300	5	232,35
0130 01 4650	46x50	450	13	98	107	1635	5	257,70

ÖZEL SERİLER (adet ve termin süresi isteyiniz)

SPECIAL SERIES (ask for quantity and delivery terms)

0130 01 0555	5x5.5	125	3.5	14	16	15	10	12,45
0130 01 0708	7x8	135	3.5	16	18	20	10	16,45
0130 01 0709	7x9	140	4	16	20	30	10	16,45
0130 01 0910	9x10	140	4	18	22	45	10	18,20
0130 01 0911	9x11	155	4.5	22	24	45	10	18,20
0130 01 1722	17x22	235	7.5	36	46	190	5	30,55
0130 01 1724	17x24	248	8.3	36	50	240	5	30,70
0130 01 2227	22x27	265	8.8	46	56	300	5	36,60

0130

İki Ağız Anahtar Takımı Uzun Boy (mm)

Double Ended Open Jaw Wrench
Long Pattern Set (mm)

TS ISO 10102



KOD CODE	İÇERİK CONTENTS	g		TL/Ad.
0130 00 2108	6x7 - 8x9 - 10x11 - 12x13 14x15 - 16x17 - 18x19 20x22	815	8	173,35
0130 00 2112	6x7 - 8x9 - 10x11 12x13 - 14x15 - 16x17 18x19 - 20x22 - 21x23 24x26 - 25x28 - 27x32	2315	12	333,20

(★) İşaretli olan ürünler stoklarla sınırlıdır.
Limited with stocks.

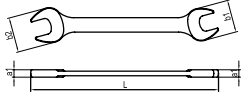
0161
İki Ağız Anahtar Uzun Boy (SAE)
Double Ended Open Jaw Wrench Long Pattern (SAE)
TSEK

Krom vanadyum, Krom kaplı
Chrom vanadium, Chrom plated

KOD CODE	inch	L mm	a1 mm	b1 mm	b2 mm	g	TL/ Ad.	
0161 01 0608	1/4"x5/16"	125	3.5	18	16	18	10	19,70
0161 01 0809	5/16"x3/8"	140	4	18	20	30	10	19,70
0161 01 0810	5/16"x11/32"	140	4	18	20	30	10	19,70
0161 01 0811	5/16"x7/16"	140	4	18	22	30	10	19,70
0161 01 0911	3/8"x7/16"	155	4.5	22	24	35	10	21,85
0161 01 1112	7/16"x1/2"	172	5	26	28	40	10	21,85
0161 01 1214	1/2"x9/16"	172	5	26	30	65	10	23,00
0161 01 1416	9/16"x5/8"	188	5.5	30	32	85	10	26,75
0161 01 1417	9/16"x11/16"	205	6.2	30	36	110	10	29,15
0161 01 1517	19/32"x11/16"	205	6.2	34	36	115	10	29,45
0161 01 1619	5/8"x3/4"	220	7	36	40	150	10	31,50
0161 01 1920	3/4"x25/32"	220	7	38	40	160	10	31,50
0161 01 2021	25/32"x13/16"	235	7.5	40	46	195	10	36,60
0161 01 1922	3/4"x7/8"	235	7.5	40	46	195	10	36,60
0161 01 2122	13/16"x7/8"	248	8.3	44	48	235	10	37,30
0161 01 2325	15/16"x1"	265	8.8	50	54	300	10	44,00
0161 01 2328	15/16"x1 1/8"	265	8.8	50	56	300	10	44,50
0161 01 2628	1 1/16"x1 1/8"	300	9.8	56	59.5	460	10	63,90
0161 01 2631	1 1/16"x1 1/4"	300	9.8	56	65.5	460	10	67,50
0161 01 2833	1 1/8"x1 5/16"	300	9.8	56	65.5	460	10	67,50

0161
İki Ağız Anahtar Takımı Uzun Boy (SAE)
Double Ended Open Jaw Wrench Long Pattern Set (SAE)
TSEK



KOD CODE	İÇERİK CONTENTS	g	TL/ Ad.	
0161 00 2108	1/4"x5/16" - 5/16"x3/8" 7/16"x1/2" - 9/16"x5/8" - 19/32"x11/16" 3/4"x25/32" - 13/16"x7/8" - 15/16"x1"	1090	8	230,25
0161 00 2112	1/4"x5/16" - 5/16"x3/8" - 3/8"x7/16" 7/16"x1/2" - 1/2"x9/16" - 9/16"x5/8" 19/32"x11/16" - 3/4"x25/32" - 13/16"x7/8" 15/16"x1" - 1 1/16"x1 1/4" 1 1/8"x1 5/16"	2165	12	410,10

0132
İki Ağız Anahtar Uzun Boy MASTER (mm)
Double Ended Open Jaw Wrench MASTER Long Pattern (mm)

TS ISO 10102
DIN 3110

Saten krom yüzeyli, Krom vanadyum, Krom kaplı
Satin chrom finish, Chrom vanadium, Chrom plated

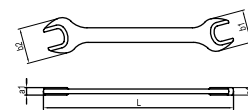
KOD CODE	mm	L mm	a1 mm	b1 mm	b2 mm	g	TL/ Ad.	
★0132 01 1415	14x15	188	5.5	30	32	85	10	23,90
★0132 01 1819	18x19	220	7	38	40	160	10	28,10
★0132 01 2528	25x28	282	9.3	52	57.5	390	5	43,90
★0132 01 2732	27x32	300	9.8	56	65.5	460	5	54,70

0220
İki Ağız Taçlı Anahtar (mm)
Double Ended Open Jaw Wrench (mm)

Krom vanadyum, Krom kaplı
Chrom vanadium, Chrom plated

KOD CODE	mm	L mm	a1 mm	b1 mm	b2 mm	g	TL/ Ad.	
★0220 01 1722	17x22	195	7.5	35.5	44.5	120	10	26,35

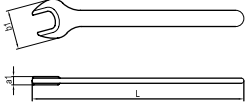
(★) İşaretili olan ürünler stoklarla sınırlıdır.
Limited with stocks.

Bir Ağız Taçlı Anahtar (mm)
Single Ended Open Jaw Wrench (mm)

Krom vanadyum
Chrom vanadium

KOD CODE	mm	L mm	a1 mm	b1 mm	g	TL/Ad.
0250 01 0030	30	260	10.5	60	250	1 73,20
0250 01 0036	36	300	10.5	74.5	370	1 92,40
0250 01 0041	41	345	12.2	85.5	550	1 120,65
0250 01 0046	46	390	14	96.5	750	1 129,85
0250 01 0050	50	423	15.2	105	1000	1 162,15
0250 01 0055	55	455	16.5	113.5	1300	1 217,25
0250 01 0060	60	490	17.6	121	1600	1 278,20
0250 01 0065	65	524	19	130	1980	1 339,15

ÖZEL SERİLER (adet ve termin süresi isteyiniz)
SPECIAL SERIES (ask for quantity and delivery terms)

0250 01 0021	21	185	8	42.4	95	1	----
0250 01 0022	22	195	8	44.4	110	1	----
0250 01 0023	23	195	8	46.3	115	1	----
0250 01 0024	24	215	9	48.3	150	1	----
0250 01 0025	25	215	9	50.3	155	1	----
0250 01 0027	27	240	9.5	54.3	200	1	----
0250 01 0032	32	274	11	63	300	1	----
0250 01 0034	34	274	11	68	320	1	----
0250 01 0038	38	300	10.5	76.8	400	1	----
0250 01 0070	70	564	20.8	140	2480	1	----
0250 01 0075	75	608	21.8	151	3100	1	----

Süper İzole Çatal Bir Ağız Anahtar (mm)
Single Ended Open Jaw Wrench Super Insulated (mm)

 IEC 60900
 Δ 1000 V

Krom vanadyum, Krom kaplı, Kalın PVC izoleli
Chrom vanadium, Chrom plated, Triple PVC insulated

KOD CODE	mm	L mm	g	TL/Ad.
0255 01 0010	10	110	40	10 42,80
0255 01 0011	11	120	45	10 45,20
0255 01 0012	12	130	50	10 47,20
0255 01 0013	13	140	60	10 50,80
0255 01 0014	14	155	75	10 52,75
0255 01 0017	17	170	100	10 64,75
0255 01 0019	19	185	150	10 76,00
0255 01 0022	22	200	200	10 102,20
0255 01 0024	24	220	280	10 125,05

Montaj Anahtar (mm)
Speed Wrench (mm)

IZELTAS YOUTUBE

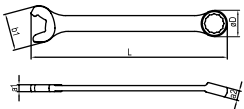
Krom vanadyum, Krom kaplı
Chrom vanadium, Chrom plated

KOD CODE	mm	L mm	a1 mm	a2 mm	b1 mm	σD mm	g	TL/Ad.
0325 02 0010	10	135	4.3	6.9	22	15.5	35	10 27,40
0325 02 0013	13	165	5.2	7.9	28	19.5	45	10 30,70
0325 02 0017	17	205	6.4	9.8	36	25.5	110	10 40,60
0325 02 0019	19	225	7	11	40	28.5	155	10 47,55
0325 02 0020	20	230	7.2	11.4	42	30	180	10 48,45
0325 02 0021	21	242	7.4	12	44	31.5	180	10 56,30
0325 02 0022	22	250	8.2	12.6	46	33	245	10 64,50

%100 Daha Hızlı

Yeni tasarlanan montaj anahtarı, 2 kat hızlıncırcır mekanizması mantığına dayanan çalışma prensibinden alır. Kullanım sırasında, montaj anahtarını civatadan ayırmadan döndürme kolaylığı kullanım hızını arttırırken, civata köşelerine sağlam tutunan anahtar profili güvenli ve kaydırmaz kullanım sağlar.

Uzun Ömür

Bu yeni montaj anahtarı profili, civata ve somunlar ile köşelerinden değil düz yüzeyleri üzerinden temas ederek düzenli tork iletimini sağlarken, gerilimin artmasını da engelleyerek anahtar ömrünün uzamasını sağlar.

• Anahtarı civatadan ayırmadan hızlı kullanılır.

• Güvenli tork iletimi ve uzun ömür.

100% Faster

The 100% new design speed wrench takes the 2-fold speed from the operating principle based on the ratchet mechanism logic. While in use, the ease of rotation without detaching the mounting wrench from the bolt increases the speed of use and the profile that firmly secured to the corners ensures safe and non-slip use

Long Life

This new mounting wrench profile by contacting bolts and nuts, not on corners, but on their flat surfaces, allows regular torx transmission, prevents the increase in surface tension and provides longer life.

• Quick use without detaching the wrench from the bolt.

• Safe torx transmission and long life.

Kombine Anahtar Kısa Boy (mm)
Combination Wrench Short Pattern (mm)

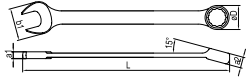
 TS 3794
 TS ISO 7738 Form A
 DIN 3113

 Krom vanadyum, Krom kaplı
Chrom vanadium, Chrom plated

KOD CODE	mm	L mm	a1 mm	a2 mm	b1 mm	øD mm	g	TL/Ad.	
0320 02 0005	5	90	3.4	5.1	14	10	15	10	15,90
0320 02 0055	5.5	90	3.4	5.1	14	10	15	10	15,90
0320 02 0006	6	100	3.4	5.1	14	10	15	10	16,45
0320 02 0007	7	110	3.6	5.5	16	11	20	10	17,50
0320 02 0008	8	120	3.8	5.9	18	13	25	10	19,05
0320 02 0009	9	130	4	6.3	20	14	30	10	19,50
0320 02 0010	10	140	4.3	6.9	22	15.5	40	10	22,00
0320 02 0011	11	150	4.5	7.3	24	17	45	10	22,55
0320 02 0012	12	160	4.9	7.7	26	18.5	55	10	24,05
0320 02 0013	13	170	5.2	7.9	28	19.5	60	10	24,60
0320 02 0014	14	180	5.5	8.7	30	21.5	75	10	26,60
0320 02 0015	15	190	5.8	9.1	32	22.5	90	10	28,45
0320 02 0016	16	200	6.1	9.6	34	24	105	10	30,55
0320 02 0017	17	210	6.4	9.8	36	25.5	120	10	32,55
0320 02 0018	18	220	6.8	10.4	38	27	145	10	36,35
0320 02 0019	19	232	7	11	40	28.5	170	10	38,25
0320 02 0020	20	240	7.2	11.4	42	30	195	10	38,95
0320 02 0021	21	250	7.4	12	44	31.5	190	10	45,20
0320 02 0022	22	260	8.2	12.6	46	33	275	10	51,60
0320 02 0023	23	270	8.3	13	48	35	255	5	51,60
0320 02 0024	24	280	8.5	13.6	50	36.5	320	5	63,15
0320 02 0025	25	290	8.8	14	52	39	320	5	63,15
0320 02 0026	26	300	9	14.8	54	41	400	5	74,40
0320 02 0027	27	310	9.3	15	56	41.5	400	5	74,40
0320 02 0028	28	320	9.4	15.4	57.5	42.5	380	5	74,40
0320 02 0029	29	330	10	15.6	59	43.5	510	5	85,20
0320 02 0030	30	340	10.3	16	61.5	44	505	5	85,20
0320 02 0032	32	370	10.5	16.2	65.5	47	560	5	89,60
0320 02 0034	34	400	10.7	16.8	71	50	675	5	93,60

0320
Kombine Anahtar Takımı Kısa Boy (mm)
Combination Wrench Short Pattern Set (mm)

KOD CODE	İÇERİK CONTENTS	g	TL/Ad.	
0320 00 2108	6 - 7 - 8 - 9 - 10 - 13 - 17 - 19	475	8	189,90
0320 00 2112	8 - 9 - 10 - 11 - 12 - 13 - 14 15 - 16 - 17 - 19 - 22	1190	12	339,75
0320 00 2117	6 - 7 - 8 - 9 - 10 - 11 - 12 - 13 - 14 15 - 16 - 17 - 18 - 19 - 20 - 21 - 22	1760	17	494,20
0320 00 2121	6 - 7 - 8 - 9 - 10 - 11 - 12 - 13 - 14 15 - 16 - 17 - 18 - 19 - 20 - 21 - 22 24 - 27 - 30 - 32	3650	21	806,55

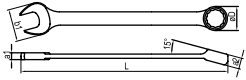
 (★) İşaretili olan ürünler stoklarla sınırlıdır.
Limited with stocks.

Kombine Anahtar Uzun Boy (mm)
Combination Wrench, Long Pattern (mm)

Krom vanadyum, Krom kaplı
 Chrom vanadium, Chrom plated

KOD CODE	mm	L mm	a1 mm	a2 mm	b1 mm	øD mm	g	TL/Ad.	
0330 02 0005	5	95	3.2	5.2	12.5	9	20	10	18,35
0330 02 0055	5.5	95	3.2	5.2	12.5	9	20	10	18,35
0330 02 0006	6	105	3.8	5.6	14	10.5	20	10	18,35
0330 02 0007	7	117	4	6.1	16	12	20	10	18,35
0330 02 0008	8	130	4.2	6.6	18	13.5	30	10	21,45
0330 02 0009	9	141	4.5	7	20	15	40	10	21,75
0330 02 0010	10	154	4.7	7.6	22	16	50	10	24,05
0330 02 0011	11	166	5	8.2	24	17.5	60	10	25,40
0330 02 0012	12	178	5.2	8.7	26	19	70	10	25,40
0330 02 0013	13	190	5.6	9.2	28	20.5	80	10	28,50
0330 02 0014	14	203	5.8	9.7	30	22	100	10	29,65
0330 02 0015	15	215	6.4	10.1	32	23.5	115	10	31,65
0330 02 0016	16	227	6.4	10.8	34	25	135	10	32,00
0330 02 0017	17	239	6.6	11.4	36	26.5	160	10	36,35
0330 02 0018	18	250	7	12	38	28	186	10	39,20
0330 02 0019	19	263	7.3	12.7	40	29.5	205	10	42,60
0330 02 0020	20	275	7.7	13.2	42	31	235	10	45,30
0330 02 0021	21	288	8.1	13.3	44	31.5	260	10	48,15
0330 02 0022	22	300	8.5	13.7	46	34	300	10	57,40
0330 02 0023	23	315	8.8	14.2	48	35.5	300	5	70,10
0330 02 0024	24	330	9	14.2	50	37	390	5	70,10
0330 02 0025	25	340	9.3	14.7	52	38.5	380	5	70,10
0330 02 0026	26	350	9.7	14.7	54	40	475	5	82,55
0330 02 0027	27	360	10	15.2	56	41	475	5	82,55
0330 02 0028	28	370	10.4	15.7	57.5	43	475	5	82,55
0330 02 0029	29	390	10.8	16.2	59	44	610	5	82,55
0330 02 0030	30	410	11.2	16.6	61.5	45	610	5	94,80
0330 02 0032	32	420	11.5	17.1	65.5	48	755	5	99,40
0330 02 0034	34	430	11.8	17.4	71	50.5	735	5	101,35
0330 02 0036	36	440	12.2	17.7	76	53	1000	5	114,80
0330 02 0038	38	450	12.5	18.7	80	56	1000	5	117,50
0330 02 0041	41	480	13.5	19.7	87	61	1240	5	133,70
0330 02 0046	46	505	14.7	20.7	95	67.5	1635	1	181,65
0330 02 0050	50	540	15.9	22.7	104	73.5	2100	1	246,35

0330
Kombine Anahtar Takımı Uzun Boy (mm)
Combination Wrench Long Pattern Set (mm)

KOD CODE	İÇERİK CONTENTS	g	TL/Ad.	
0330 00 2108	6 - 7 - 8 - 9 - 10 - 13 17 - 19	665	8	211,40
0330 00 2112	8 - 9 - 10 - 11 - 12 13 - 14 - 15 - 16 17 - 19 - 22	1780	12	376,20
0330 00 2117	6 - 7 - 8 - 9 - 10 11 - 12 - 13 - 14 - 15 16 - 17 - 18 - 19 20 - 21 - 22	2170	17	545,55
0330 00 2121	6 - 7 - 8 - 9 - 10 - 11 12 - 13 - 14 - 15 - 16 17 - 18 - 19 - 20 - 21 22 - 24 - 27 - 30 - 32	4465	21	892,40

0331

Kombine Anahtar Uzun Boy (SAE) Combination Wrench Long Pattern (SAE)

TSEK

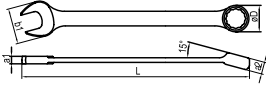

Krom vanadyum, Krom kaplı
Chrom vanadium, Chrom plated

KOD CODE	inch	L mm	a1 mm	a2 mm	b1 mm	ØD mm	g	TL/Ad.
0331 02 0005	3/16"	95	3.2	5.2	12.5	9	15	10 22,00
0331 02 0006	1/4"	105	3.8	5.6	14	10.5	20	10 22,90
0331 02 0008	5/16"	130	4.2	6.6	18	13.5	30	10 26,65
0331 02 0010	3/8"	154	4.7	7.6	22	16	50	10 30,40
0331 02 0011	7/16"	166	5	8.2	24	17.5	60	10 31,90
0331 02 0013	1/2"	190	5.6	9.2	28	20.5	80	10 36,00
0331 02 0014	9/16"	203	5.8	9.7	30	22	100	10 37,85
0331 02 0015	19/32"	215	6.4	10.1	32	23.5	115	10 40,10
0331 02 0016	5/8"	227	6.4	10.8	34	25	135	10 43,10
0331 02 0017	11/16"	239	6.6	11.4	36	26.5	155	10 45,90
0331 02 0019	3/4"	263	7.3	12.7	40	29.5	205	10 53,50
0331 02 0020	25/32"	275	7.7	13.2	42	31	230	10 57,25
0331 02 0021	13/16"	288	8.1	13.3	44	31.5	260	5 63,20
0331 02 0022	7/8"	300	8.5	13.7	46	34	310	5 72,80
0331 02 0024	15/16"	330	9	14.2	50	37	380	5 89,05
0331 02 0025	1"	340	9.3	14.7	52	38.5	380	5 89,05
0331 02 0027	1 1/16"	360	10	15.2	56	41	470	5 104,25
0331 02 0028	1 1/8"	370	10.4	15.7	57.5	43	470	5 104,25
0331 02 0030	1 3/16"	410	11.2	16.6	61.5	45	635	5 119,40
0331 02 0032	1 1/4"	420	11.5	17.1	65.5	48	775	5 125,15
0331 02 0033	1 5/16"	430	11.8	17.4	71	50.5	775	5 125,15
0331 02 0038	1 1/2"	450	12.5	18.7	80	56	1015	5 151,30

ÖZEL SERİLER (adet ve termin süresi isteyiniz)
SPECIAL SERIES (ask for quantity and delivery terms)

0331 02 0035	1 3/8"	440	12.2	17.7	76	53	1015	5 137,55
0331 02 0036	1 7/16"	440	12.2	17.7	76	53	1015	5 137,55
0331 02 0041	1 5/8"	480	13.5	19.7	87	61	1325	5 160,35
0331 02 0046	1 13/16"	505	14.7	20.7	95	67.5	1750	5 218,00
0331 02 0050	2"	540	15.9	22.7	104	73.5	2200	5 295,55

0331

Kombine Anahtar Takımı Uzun Boy (SAE) Combination Wrench Long Pattern Set (SAE)

TSEK



KOD CODE	İÇERİK CONTENTS	g	TL/Ad.
0331 00 2108	5/16" - 3/8" - 7/16" - 1/2" - 9/16" - 5/8" - 11/16" - 3/4"	925	8 305,30
0331 00 2112	5/16" - 3/8" - 7/16" - 1/2" - 9/16" - 5/8" - 11/16" - 3/4" - 13/16" - 7/8" - 15/16" - 1"	2320	12 619,40
0331 00 2117	1/4" - 5/16" - 3/8" - 7/16" - 1/2" - 9/16" - 19/32" - 5/8" - 11/16" - 3/4" - 25/32" - 13/16" - 7/8" - 15/16" - 1" - 1 1/16" - 1 3/16"	3875	17 963,30
0331 00 2120	1/4" - 5/16" - 3/8" - 7/16" - 1/2" - 9/16" - 19/32" - 5/8" - 11/16" - 3/4" - 25/32" - 13/16" - 7/8" - 15/16" - 1" - 1 1/16" - 1 1/8" - 1 3/16" - 1 1/4" - 1 5/16"	5880	20 1317,85

0322

Kombine Anahtar Kısa Boy MASTER (mm) Combination Wrench MASTER Short Pattern (mm)

TSE

TS 3794
TS ISO 7738 Form A
DIN 3113

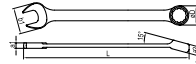

Saten krom yüzeyli, Krom vanadyum, Krom kaplı
Satin chrom finish, Chrom vanadium, Chrom plated

KOD CODE	mm	L mm	a1 mm	a2 mm	b1 mm	ØD mm	g	TL/Ad.
★0322 02 0006	6	100	3.4	5.1	14	10	15	10 16,10
★0322 02 0007	7	110	3.6	5.5	16	11	20	10 17,15
★0322 02 0008	8	120	3.8	5.9	18	13	25	10 18,55
★0322 02 0009	9	130	4	6.3	20	14	30	10 19,20
★0322 02 0011	11	150	4.5	7.3	24	17	45	10 22,20
★0322 02 0012	12	160	4.9	7.7	26	18.5	55	10 23,65
★0322 02 0014	14	180	5.5	8.7	30	21.5	75	10 26,25
★0322 02 0015	15	190	5.8	9.1	32	22.5	90	10 28,00
★0322 02 0016	16	200	6.1	9.6	34	24	105	10 30,00
★0322 02 0017	17	210	6.4	9.8	36	25.5	120	10 32,10
★0322 02 0018	18	220	6.8	10.4	38	27	145	10 35,70
★0322 02 0019	19	232	7	11	40	28.5	170	10 37,50
★0322 02 0020	20	240	7.2	11.4	42	30	195	10 38,15
★0322 02 0021	21	250	7.4	12	44	31.5	190	10 44,50
★0322 02 0022	22	260	8.2	12.6	46	33	275	10 50,90
★0322 02 0024	24	280	8.5	13.6	50	36.5	320	5 55,95
★0322 02 0025	25	290	8.8	14	52	39	340	5 61,50
★0322 02 0026	26	300	9	14.8	54	41	400	5 67,65
★0322 02 0030	30	340	10.3	16	61.5	44	505	5 81,15

(★) İşaretli olan ürünler stoklarla sınırlıdır.
Limited with stocks.

Cırcır Kombine Anahtar (mm)
Combination Wrench With Ratchet (mm)

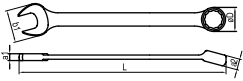

Krom vanadyum, Krom kaplı
Chrom vanadium, Chrom plated

KOD CODE	mm	L mm	a1 mm	a2 mm	b1 mm	øD mm	g		TL/Ad.
0340 02 0008	8	136	5.1	7	18	17.5	35	10	63,65
0340 02 0009	9	143	5.4	7.6	20	19.5	40	10	63,65
0340 02 0010	10	160	5.8	7.7	22	21	55	10	65,80
0340 02 0011	11	168	6.1	8.3	24.5	22.5	70	10	66,15
0340 02 0012	12	174	6.4	8.7	26.5	24	80	10	71,65
0340 02 0013	13	180	6.7	9.3	27.5	26	90	10	76,80
0340 02 0014	14	193	7.4	9.4	31.5	27.5	120	10	79,10
0340 02 0015	15	200	7.7	10	33.5	29	135	10	83,85
0340 02 0016	16	216	8.1	10.6	34.5	30.5	155	10	96,10
0340 02 0017	17	233	8.8	10.9	38.5	33	190	10	101,70
0340 02 0018	18	239	9	11.2	40	33.5	200	10	110,25
0340 02 0019	19	250	9.5	11.5	41.5	35	240	10	117,10
0340 02 0021	21	285	10.2	13	46	42	350	10	162,95
0340 02 0022	22	285	10.2	13	46	42	340	10	178,70
0340 02 0024	24	325	11	14.5	51.5	47.5	470	5	201,90

0340

Cırcır Kombine Anahtar Takımı (mm)
Combination Wrench With Ratchet, Set (mm)

0335

Çoklu Yıldız Cırcır Anahtar (mm)
Multi-Ring Wrench (mm)



Krom vanadyum, Krom kaplı
Chrom vanadium, Chrom plated

KOD CODE	ÖLÇÜ SIZE	L mm	g		TL/Ad.
0335 02 0010	10x13x17x19	230	215	5	244,80

KOD CODE	İÇERİK CONTENTS	g		TL/Ad.
0340 00 2110	8 - 9 - 10 - 11 12 - 13 - 14 - 15 17 - 19	1315	10	789,45
0340 00 2115	8 - 9 - 10 - 11 - 12 - 13 14 - 15 - 16 - 17 - 18 19 - 21 - 22 - 24	2445	15	1539,35

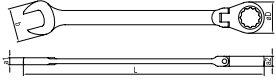
0345
Mafsallı Cırcır Kombine Anahtar (mm)
Flexible Head Combination Wrench With Ratchet (mm)

Krom vanadyum, Krom kaplı
 Chrom vanadium, Chrom plated

KOD CODE	mm	L mm	a1 mm	a2 mm	b mm	σD mm	g	TL/ Ad.
0345 02 0008	8	136	5.5	7	17	17.5	40	10
0345 02 0009	9	140	6.1	7.7	21.5	21	50	10
0345 02 0010	10	140	6.1	7.7	21.5	21	60	10
0345 02 0011	11	142	6.4	8.3	23.5	22.5	80	10
0345 02 0012	12	143	6.7	8.7	26	24	90	10
0345 02 0013	13	156	7	9.3	27	26	105	10
0345 02 0014	14	164	7.3	9.4	30.5	27.5	125	10
0345 02 0015	15	174	7.7	10	32	29	145	10
0345 02 0016	16	176	8	10.6	34	30.5	185	10
0345 02 0017	17	195	8.3	10.9	37	32.5	210	10
0345 02 0018	18	213	8.6	11.2	38.5	33.5	235	10
0345 02 0019	19	214	9	11.5	40	35	260	10

0360
XL Ekstra Uzun Kombine Anahtar (mm)
Extra Long (XL) Combination Wrench (mm)

0345
Mafsallı Cırcır Kombine Anahtar Takımı (mm)
Flexible Head Combination Wrench With Ratchet, Set (mm)

KOD CODE	İÇERİK CONTENTS	g	TL/Ad.
0345 00 2112	8 - 9 - 10 - 11 - 12 - 13 14 - 15 - 16 - 17 - 18 - 19	1365	12

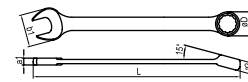

Krom vanadyum, Krom kaplı
 Chrom vanadium, Chrom plated

KOD CODE	mm	L mm	a1 mm	a2 mm	b1 mm	σD mm	g	TL/ Ad.
★0360 02 0008	8	170	4.5	7.5	20.5	13	45	10
★0360 02 0009	9	180	4.5	8	22.5	14.5	55	10
★0360 02 0010	10	190	5	8.5	24.5	16	60	10
★0360 02 0011	11	200	5.5	9	26.5	17	75	10
★0360 02 0012	12	210	6	9.5	28.5	19	90	10
★0360 02 0014	14	235	7	11	32.5	22	120	10
★0360 02 0015	15	250	7.5	12	34.5	23	150	10
★0360 02 0016	16	265	8	13	36.5	24.5	175	10
★0360 02 0018	18	295	9	15	40.5	28	240	10
★0360 02 0020	20	310	9.5	16	42.5	31	265	10
★0360 02 0030	30	480	14	21	65	47	870	1
★0360 02 0032	32	500	15	22	67	49.5	1000	1
★0360 02 0034	34	520	15	23	70	53	1100	1
★0360 02 0041	41	600	16	26	86	63.5	1700	1
★0360 02 0046	46	640	17.4	27	96	71	2230	1

(★) İşaretili olan ürünler stoklarla sınırlıdır.
 Limited with stocks.

Boyunlu Kombine Anahtar (mm)
Offset Combination Wrench (mm)

TS 3794
TS ISO 7738 Form B
DIN 3113

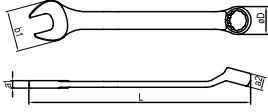

Krom vanadyum, Krom kaplı
Chrom vanadium, Chrom plated

0370
Boyunlu Kombine Anahtar Takımı (mm)
Offset Combination Wrench, Set (mm)

KOD CODE	mm	L mm	a1 mm	a2 mm	b1 mm	σD mm	g	TL/Ad.	
0370 02 0006	6	110	3.8	5.6	16	10.5	20	10	18,90
0370 02 0007	7	120	4	6.2	18	12	25	10	20,15
0370 02 0008	8	130	4.2	6.7	20	13	30	10	21,85
0370 02 0009	9	140	4.4	7.3	22	14.5	35	10	22,35
0370 02 0010	10	150	4.6	7.8	24	16	40	10	25,30
0370 02 0011	11	160	4.8	8.4	26	17	50	10	26,05
0370 02 0012	12	167	5	9	28	18.5	65	10	27,95
0370 02 0013	13	175	5.4	9.6	30	20	75	10	28,65
0370 02 0014	14	185	5.8	10.2	32	21.5	90	10	30,70
0370 02 0015	15	195	6.2	10.8	34	23	105	10	32,65
0370 02 0016	16	210	6.6	11.4	36	24.5	120	10	35,10
0370 02 0017	17	225	7	12	38	26	160	10	37,45
0370 02 0018	18	237	7.4	12.4	40	27.5	170	10	41,80
0370 02 0019	19	250	7.8	13	42	29	200	10	44,00
0370 02 0020	20	267	8.2	13.2	44	30.5	230	10	46,20
0370 02 0021	21	283	8.6	13.8	46	32	265	10	51,95
0370 02 0022	22	295	9.1	14.6	48	34.5	300	10	59,50
0370 02 0023	23	295	9.1	14.6	48	34.5	300	5	72,70
0370 02 0024	24	329	9.4	15.4	52	37	380	5	72,70
0370 02 0025	25	329	9.4	15.4	52	37	380	5	72,70
0370 02 0026	26	360	10.2	16.8	58	41	485	5	85,55
0370 02 0027	27	360	10.2	16.8	58	41	475	5	85,55
0370 02 0028	28	360	10.2	16.8	58	41	470	5	85,55
0370 02 0029	29	394	11	18.2	64	44.5	610	5	95,30
0370 02 0030	30	394	11	18.2	64	44.5	620	5	98,25
0370 02 0032	32	435	11.8	19.7	66	47.5	765	5	103,10
0370 02 0036	36	468	12.6	21.2	76	53	1020	5	119,15

KOD CODE	İÇERİK CONTENTS	g	TL/Ad.	
0370 00 2108	6 - 7 - 8 - 9 - 10 - 13 - 17 - 19	665	8	218,65
0370 00 2112	8 - 9 - 10 - 11 - 12 - 13 - 14 15 - 16 - 17 - 19 - 22	1375	12	391,55
0370 00 2117	6 - 7 - 8 - 9 - 10 - 11 - 12 - 13 - 14 15 - 16 - 17 - 18 - 19 - 20 - 21 - 22	2100	17	570,55
0370 00 2121	6 - 7 - 8 - 9 - 10 - 11 - 12 - 13 - 14 - 15 16 - 17 - 18 - 19 - 20 - 21 - 22 - 24 - 27 30 - 32	4425	21	930,15

Torx® - mm Kombine Anahtar
Torx®- mm Combination Wrench

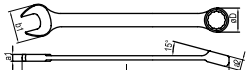

Krom vanadyum, Krom kaplı
Chrom vanadium, Chrom plated

KOD CODE	mm	*	L mm	a1 mm	a2 mm	b1 mm	øD mm	g	□	TL/ Ad.
0380 02 0008	8	E10	170	4.5	7.5	20.5	13	45	10	38,10
0380 02 0009	9	E12	180	4.5	8	22.5	14.5	45	10	38,70
0380 02 0010	10	E14	190	5	8.5	24.5	16	60	10	42,90
0380 02 0011	11	E14	200	5.5	9	26.5	17	75	10	45,25
0380 02 0012	12	E16	210	6	9.5	28.5	19	90	10	46,45
0380 02 0013	13	E18	225	6.5	10	30.5	20	110	10	51,00
0380 02 0014	14	E18	235	7	11	32.5	22	120	10	56,40
0380 02 0015	15	E20	250	7.5	12	34.5	23	150	10	59,70
0380 02 0017	17	E22	280	8.5	14	38.5	26.5	210	10	64,85
0380 02 0018	18	E24	295	9	15	40.5	28	240	10	70,35
0380 02 0019	19	E24	310	9.5	16	42.5	29.5	280	10	76,20
0380 02 0022	22	E26	350	11	18	48.5	34.5	410	10	102,45

0380

Torx® - mm Kombine Anahtar Takımı
Torx®- mm Combination Wrench Set



Torx® - mm Kombine Anahtar: Bir çatal ağız ve bir yıldız ağızdan oluşan anahtarlarımız 8-22 mm arasında boyları bulunmaktadır. Çatal ağız kısmı mevcut çatal anahtarlardan farklı olarak 6 köşe avatanın yanısıra farklı geometri lere sahip avataları açabilmekte ve sıkabilmektedir.

TORX-mm combination wrench: Our wrenches consisting of an open end and a ring end are available in sizes from 8 to 22 mm. Unlike the existing open end wrenches, its open end can unbolt and tighten bolts with different geometries as well as the

KOD CODE	İÇERİK CONTENTS	g	□	TL/ Ad.
	8 - 9 - 10 - 11 - 12 - 13 - 17 - 19			
0380 00 2108	E10 - E12 - E14 - E14 E16 - E18 - E22 - E24	790	8	403,45
	8 - 9 - 10 - 11 - 12 - 13 14 - 15 - 17 - 18 - 19 - 22			
0380 00 2112	E10 - E12 - E14 - E14 - E16 - E18 E18 - E20 - E22 - E24 - E24 - E26	1590	12	692,35

(*) İşaretili olan ürünler stoklarla sınırlıdır.
Limited with stocks.

Yıldız İki Ağız Anahtar (mm)
Double Ended Ring Wrench (mm)

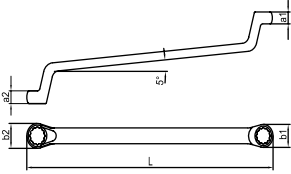
 TS 3794
 TS ISO 10104 Form B
 DIN 838

Krom vanadyum, Krom kaplı
Chrom vanadium, Chrom plated

KOD CODE	mm	L mm	a1 mm	a2 mm	b1 mm	b2 mm	g	TL/Ad.
0430 03 0607	6x7	176	5.6	6	10	11.5	55	10 28,50
0430 03 0809	8x9	190	6.4	6.8	13	14.5	75	10 28,90
0430 03 0810	8x10	190	6.4	7.3	13	15.5	70	10 28,90
0430 03 1011	10x11	206	7.3	7.6	15.5	17	105	10 32,00
0430 03 1012	10x12	206	7.3	8.5	15.5	18.5	105	10 32,00
0430 03 1013	10x13	220	7.3	9	15.5	20	120	10 36,35
0430 03 1113	11x13	220	8.5	9	18.5	20	130	10 36,35
0430 03 1213	12x13	220	8.5	9	18.5	20	135	10 36,35
0430 03 1214	12x14	220	8.5	9.5	18.5	23	145	10 36,35
0430 03 1415	14x15	236	9.5	10	21.5	23	180	10 38,25
0430 03 1317	13x17	250	9	11.5	20	26.5	215	10 43,30
0430 03 1417	14x17	250	9.5	11.5	21.5	26.5	210	10 43,30
0430 03 1617	16x17	250	10.8	11.5	25	26.5	220	10 43,30
0430 03 1618	16x18	260	10.8	12	25	27.5	210	10 51,45
0430 03 1719	17x19	271	11.5	12.5	26.5	29	270	10 51,45
0430 03 1819	18x19	271	12	12.5	27.5	29	270	10 51,45
0430 03 1922	19x22	291	12.5	13.5	29	33	330	5 56,50
0430 03 1924	19x24	311	12.5	14.2	29	36.5	345	5 56,50
0430 03 2022	20x22	291	12.9	13.5	30.5	33	330	5 56,50
0430 03 2123	21x23	311	13.1	14	32	35	410	5 64,75
0430 03 2224	22x24	321	13.5	14.2	33	36.5	410	5 64,75
0430 03 2426	24x26	331	14.2	14.6	36.5	39.5	495	5 75,45
0430 03 2427	24x27	331	14.2	15	36.5	40.5	495	5 75,45
0430 03 2430	24x30	352	14.2	16.7	36.5	45	530	5 82,55
0430 03 2528	25x28	352	14.5	15.5	38	42.5	550	5 82,55
0430 03 2729	27x29	371	15	16.7	40.5	45	660	5 90,80
0430 03 2730	27x30	371	15	16.7	40.5	45	660	5 90,80
0430 03 2732	27x32	371	15	16.7	40.5	47.5	660	5 90,80
0430 03 3032	30x32	371	16.4	16.7	45	47.5	660	5 90,80
0430 03 3036	30x36	402	16.4	17.5	45	53	880	5 140,05
0430 03 3236	32x36	402	16.7	17.5	47.5	53	890	5 140,05
0430 03 3436	34x36	420	17.1	17.5	50	53	1000	5 171,20
0430 03 3641	36x41	438	17.5	19.5	53	61	1150	5 190,25
0430 03 4146	41x46	485	19.5	20.5	61	67.5	1430	5 260,70
0430 03 4650	46x50	535	20.5	22.4	67.5	73.5	1960	5 414,80

ÖZEL SERİLER (adet ve termin süresi isteyiniz)
SPECIAL SERIES (ask for quantity and delivery terms)

0430 03 1014	10x14	220	7.3	9	15.5	21.5	120	10	36,35
0430 03 1315	13x15	236	9	10	20	23	170	10	38,25
0430 03 2227	22x27	331	14.2	15	36.5	40.5	500	5	75,45
0430 03 3034	30x34	379	16.4	16.9	45	50	690	5	120,70

0430
Yıldız İki Ağız Anahtar Takımı (mm)
Double Ended Ring Wrench Set (mm)

KOD CODE	İÇERİK CONTENTS	g	TL/Ad.
0430 00 2108	6x7 - 8x9 - 10x11 - 12x13 - 14x15 16x17 - 18x19 - 20x22	1450	8 315,25
0430 00 2112	6x7 - 8x9 - 10x11 - 12x13 - 14x15 16x17 - 18x19 - 20x22 - 21x23 24x26 - 25x28 - 27x32	3610	12 628,80

0431

Yıldız İki Ağız Anahtar (SAE) Double Ended Ring Wrench (SAE)

TSEK



KOD CODE	inch	L mm	a1 mm	a2 mm	b1 mm	b2 mm	g	TL/ Ad.
0431 03 0608	1/4"x5/16"	176	5.6	6	10	11.5	55	10 35,25
0431 03 0809	5/16"x3/8"	190	6.4	6.8	13	14.5	75	10 36,60
0431 03 0811	5/16"x7/16"	190	6.4	7.3	13	15.5	115	10 38,35
0431 03 0911	3/8"x7/16"	206	7.3	7.6	15.5	17	115	10 40,35
0431 03 1112	7/16"x1/2"	220	8.5	9	18.5	20	135	10 43,55
0431 03 1214	1/2"x9/16"	236	9	10	20	23	145	10 45,90
0431 03 1415	9/16"x19/32"	236	9.5	10	21.5	23	165	10 45,90
0431 03 1416	9/16"x5/8"	236	9.5	10	21.5	24	165	10 46,30
0431 03 1517	19/32"x11/16"	250	10.8	11.5	25	26.5	210	10 51,95
0431 03 1920	3/4"x25/32"	271	12	12.5	27.5	29	270	10 64,50
0431 03 2122	13/16"x7/8"	311	13.1	14	32	35	400	5 77,60
0431 03 2325	15/16"x1"	331	14.2	14.6	36.5	39.5	495	5 90,45
0431 03 2631	1 1/16"x1 1/4"	371	15	16.7	40.5	48	640	5 109,00
0431 03 2833	1 1/8"x1 5/16"	371	15	16.7	40.5	48	660	5 109,00
0431 03 3033	1 3/16"x1 5/16"	371	16.4	16.7	45	48	670	5 116,25

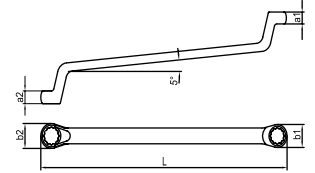

Krom vanadyum, Krom kaplı
Chrom vanadium, Chrom plated

0431

Yıldız İki Ağız Anahtar Takımı (SAE) Double Ended Ring Wrench, Set (SAE)

TSEK

ÖZEL SERİLER (adet ve termin süresi isteyiniz) SPECIAL SERIES (ask for quantity and delivery terms)

0431 03 1217	1/2"x11/16"	250	9	10	20	26.5	185	10 51,95
0431 03 1417	9/16"x11/16"	250	9.5	11.5	21.5	26.5	185	10 51,95
0431 03 1617	5/8"x11/16"	250	10.8	11.5	25	26.5	210	10 51,95
0431 03 1619	5/8"x3/4"	271	11.5	12.5	26.5	29	270	10 61,90
0431 03 2021	25/32"x13/16"	291	12.9	13.5	30.5	33	270	5 67,70
0431 03 1922	3/4"x7/8"	291	12.9	13.5	30.5	33	400	5 67,70
0431 03 2223	7/8"x15/16"	321	13.5	14.2	33	36.5	400	5 77,60
0431 03 2328	15/16"x1 1/8"	331	14.2	15	36.5	40.5	500	5 90,45
0431 03 2528	1"x1 1/8"	352	14.5	15.5	38	42.5	570	5 99,00
0431 03 3036	1 3/16"x1 3/8"	402	16.4	17.5	45	53	880	5 168,00
0431 03 3236	1 1/4"x1 7/16"	402	16.7	17.5	48	53	890	5 168,00
0431 03 3641	1 7/16"x1 5/8"	438	17.5	19.5	53	61	1100	5 228,35
0431 03 4146	1 11/16"x1 7/8"	485	19.5	20.5	61	67.5	1390	5 312,75
0431 03 4650	1 13/16"x2"	535	20.5	22.5	67.5	73.5	1955	5 497,65



0432

Yıldız İki Ağız Anahtar MASTER (mm) Double Ended Ring Wrench (mm) MASTER



TS 3794
TS ISO 10104 Form B
DIN 838



Saten krom yüzeyli, Krom vanadyum, Krom kaplı
Satin chrom finish, Chrom vanadium, Chrom plated

KOD CODE	mm	L mm	a1 mm	a2 mm	b1 mm	b2 mm	g	TL/ Ad.
★0432 03 0607	6x7	176	5.6	6	10	11.5	55	10 26,90
★0432 03 1819	18x19	271	12	12.5	27.5	29	270	10 48,60
★0432 03 2528	25x28	352	14.5	15.5	38	42.5	550	5 77,90
★0432 03 2732	27x32	371	15	16.7	40.5	47.5	660	5 85,75

KOD CODE	İÇERİK CONTENTS	g	TL/ Ad.
0431 00 2108	1/4"x5/16" - 5/16"x3/8" 7/16"x1/2" - 9/16"x5/8" 19/32"x11/16" 3/4"x25/32" - 13/16"x7/8" 15/16"x1"	1915	8 446,20
0431 00 2112	1/4"x5/16" - 5/16"x3/8" 3/8"x7/16" - 7/16"x1/2" 9/16"x5/8" - 19/32"x11/16" 3/4"x25/32" - 13/16"x7/8" 15/16"x1" - 1 1/16"x1 1/4" 1 1/8"x1 5/16" 1 3/16"x1 5/16"	3985	12 820,80

Düz Yıldız Anahtar (mm)
Flat Ring Wrench (mm)

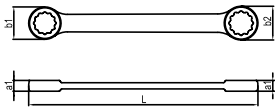
 TS 3794
 TS ISO 10103
 DIN 837 - B

Krom vanadyum, Krom kaplı
Chrom vanadium, Chrom plated

KOD CODE	mm	L mm	a1 mm	b1 mm	b2 mm	g	TL/Ad.
0440 03 0607	6x7	99	4.4	9.5	11	10	26,25
0440 03 0809	8x9	113	5.2	12.5	14	25	27,40
0440 03 1011	10x11	125	6	15.5	16.5	30	30,40
0440 03 1213	12x13	140	6.8	18.5	20	45	32,80
0440 03 1415	14x15	156	7.2	21	22.5	60	38,25
0440 03 1617	16x17	170	8	24	25	80	45,30
0440 03 1819	18x19	188	8.8	26.5	27.5	105	47,35
0440 03 2022	20x22	208	9.6	29	32	135	55,00
0440 03 2123	21x23	230	10.6	30	33	170	65,15
0440 03 2426	24x26	256	10.8	35	37.5	225	65,95
0440 03 2528	25x28	280	11.8	36	40.5	270	77,05
0440 03 2732	27x32	310	12.8	38.5	45.5	355	95,20

0440
Düz Yıldız Anahtar Takımı (mm)
Flat Ring Wrench, Set (mm)

ÖZEL SERİLER (adet ve termin süresi isteyiniz)
SPECIAL SERIES (ask for quantity and delivery terms)

0440 03 0810	8x10	120	5.6	12.5	15.5	30	10	29,35
0440 03 1013	10x13	140	6.8	18.5	20	45	10	32,80
0440 03 1315	13x15	156	7.2	20	22.5	55	10	38,25
0440 03 1317	13x17	165	7.8	20.2	25.2	85	10	45,30
0440 03 1618	16x18	188	8.8	26.5	27.5	90	10	47,35
0440 03 1719	17x19	188	8.8	26.5	27.5	105	10	47,35
0440 03 2224	22x24	230	10.8	32	35	170	10	65,15
0440 03 2427	24x27	256	10.8	35	38.5	225	10	65,95
0440 03 2729	27x29	290	12.8	38.5	42.5	285	10	88,05
0440 03 3032	30x32	310	12.8	43	45.5	360	10	95,20

KOD CODE	İÇERİK CONTENTS	g	TL/Ad.
0440 00 2108	6x7 - 8x9 - 10x11 - 12x13 - 14x15 16x17 - 18x19 - 20x22	560	8 302,75
0440 00 2112	6x7 - 8x9 - 10x11 - 12x13 - 14x15 16x17 - 18x19 - 20x22 - 21x23 24x26 - 25x28 - 27x32	1540	12 606,10

0435

Süper İzoleli Bir Ağız Yıldız Anahtar (mm) Single Ended Ring Wrench Super Insulated (mm)

IEC 60900
△ 1000 V



Krom vanadyum, Krom kaplı, Kalın PVC izoleli
Chrom vanadium, Chrom plated, Triple PVC insulated

KOD CODE	mm	L mm	g	TL/Ad.
0435 03 0010	10	170	100	57,05
0435 03 0011	11	175	110	57,05
0435 03 0012	12	180	130	64,75
0435 03 0013	13	185	150	64,75
0435 03 0014	14	190	180	67,95
0435 03 0017	17	205	220	77,00
0435 03 0019	19	220	270	91,85
0435 03 0022	22	245	310	100,70
0435 03 0024	24	270	420	134,55

0530

Yarım Ay Anahtar Yıldız İki Ağız (mm) Double - Hex Starter and Block Wrench (mm)

TSEK

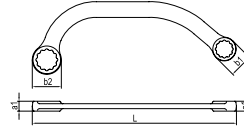

Krom vanadyum, Krom kaplı
Chrom vanadium, Chrom plated

KOD CODE	mm	L mm	a1 mm	b1 mm	b2 mm	g	TL/Ad.
0530 04 0810	8x10	120	6	12.5	15.5	30	33,80
0530 04 1011	10x11	150	7	17	20	55	39,70
0530 04 1012	10x12	150	7	17	20	55	39,70
0530 04 1113	11x13	150	7	17	20	55	39,70
0530 04 1315	13x15	185	9	21.5	26	110	47,30
0530 04 1317	13x17	185	9	21.5	26	105	47,30
0530 04 1417	14x17	185	9	21.5	26	110	47,30
0530 04 1517	15x17	185	9	21.5	26	100	47,30
0530 04 1922	19x22	230	11	29	33	195	61,55

0540

Rakor Anahtar (mm) Flarenut Wrench (mm)

DIN 3118

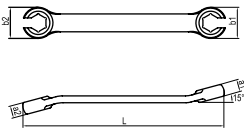

Krom vanadyum, Krom kaplı
Chrom vanadium, Chrom plated

KOD CODE	mm	L mm	a1 mm	a2 mm	b1 mm	b2 mm	g	TL/Ad.
0540 01 0810	8x10	130	7	8.5	18	20	60	48,70
0540 01 1011	10x11	150	8.5	9.3	20	22	75	50,55
0540 01 1012	10x12	150	8.5	9.3	20	22	75	50,55
0540 01 1113	11x13	170	9.3	10.8	22	25.5	105	54,15
0540 01 1214	12x14	170	9.3	10.8	22	25.5	105	54,15
0540 01 1719	17x19	210	11.8	13	30.5	33.5	185	96,65
0540 01 1922	19x22	230	12.8	14.9	33.5	39.5	235	115,75

0531

Yarım Ay Anahtar Yıldız İki Ağız (SAE) Double - Hex Starter and Block Wrench (SAE)

TSEK

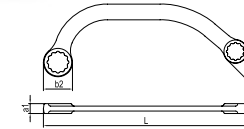

Krom vanadyum, Krom kaplı
Chrom vanadium, Chrom plated

KOD CODE	inch	L mm	a1 mm	b1 mm	b2 mm	g	TL/Ad.
0531 04 1112	7/16"x1/2"	150	7	17	20	50	48,95
0531 04 1214	1/2"x9/16"	185	9	21.5	26	110	56,90
0531 04 1416	9/16"x5/8"	185	9	21.5	26	115	58,65
0531 04 1922	3/4"x7/8"	230	11	29	33	195	73,90

ÖZEL SERİLER (adet ve termin süresi isteyiniz)
SPECIAL SERIES (ask for quantity and delivery terms)

0531 04 0809	5/16"x3/8"	120	6	12.5	15.5	30	40,50
0531 04 0911	3/8"x7/16"	150	7	17	20	50	47,65
0531 04 1417	9/16"x11/16"	185	9	21.5	26	110	56,70

Çatal Çakma Anahtar (mm)
Slugging Open Jaw Wrench (mm)

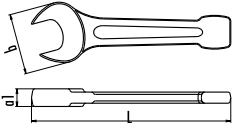
 TS 81
 DIN 133

 Krom vanadyum
Chrom vanadium

KOD CODE	mm	L mm	a1 mm	b mm	g		TL/Ad.
0700 05 0024	24	160	14	50	280	1	68,20
0700 05 0027	27	180	15	55	385	1	84,65
0700 05 0030	30	190	16	64	525	1	104,00
0700 05 0032	32	190	16	64	530	1	116,75
0700 05 0036	36	210	18	75	755	1	131,10
0700 05 0038	38	210	18	75	760	1	157,80
0700 05 0041	41	230	18	85	920	1	171,35
0700 05 0042	42	230	18	85	930	1	198,00
0700 05 0046	46	255	20	95	1305	1	217,90
0700 05 0047	47	255	20	95	1320	1	254,50
0700 05 0050	50	275	20	105	1565	1	272,30
0700 05 0055	55	310	23	119	2305	1	365,00
0700 05 0060	60	310	23	119	2310	1	396,25
0700 05 0065	65	340	28	135	3300	1	570,00
0700 05 0070	70	375	31	154	4555	1	729,70
0700 05 0075	75	375	31	154	4460	1	773,10
0700 05 0080	80	405	34	169	6115	1	983,20
0700 05 0085	85	405	34	169	5740	1	1303,35
0700 05 0090	90	445	38	189	8040	1	1341,00
0700 05 0095	95	445	38	189	8160	1	1430,05
0700 05 0100	100	485	44	214	12355	1	2026,85
0700 05 0105	105	485	44	214	11785	1	2090,05
0700 05 0110	110	510	50	234	15000	1	2384,81
0700 05 0115	115	510	50	234	14830	1	2739,60
0700 05 0120	120	543	54	254	18865	1	2891,75

ÖZEL SERİLER (adet ve termin süresi isteyiniz)
SPECIAL SERIES (ask for quantity and delivery terms)

0700 05 0125	125	543	54	254	17250	1	-----
0700 05 0130	130	560	56	275	20000	1	-----
0700 05 0135	135	560	56	275	19700	1	-----
0700 05 0140	140	630	58.5	310	19400	1	-----
0700 05 0145	145	630	58.5	310	28000	1	-----
0700 05 0150	150	630	58.5	310	27600	1	-----

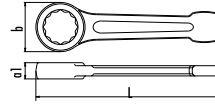
Yıldız Çakma Anahtar (mm)
Slugging Ring Wrench (mm)

 TS 3794
 DIN 7444

 Krom vanadyum
Chrom vanadium

KOD CODE	mm	L mm	a1 mm	b mm	g		TL/Ad.
0750 05 0024	24	160	15	41.5	235	1	95,60
0750 05 0027	27	180	16	45.5	325	1	114,10
0750 05 0030	30	190	17	51	435	1	136,20
0750 05 0032	32	190	17	51	425	1	156,45
0750 05 0036	36	205	19	58	550	1	177,05
0750 05 0038	38	205	19	58	530	1	212,05
0750 05 0041	41	225	20	63	730	1	231,50
0750 05 0042	42	225	20	63	700	1	264,70
0750 05 0046	46	240	22	71	970	1	276,80
0750 05 0047	47	240	22	71	930	1	305,45
0750 05 0050	50	255	23	77	1160	1	326,85
0750 05 0055	55	272	25	88	1520	1	459,80
0750 05 0060	60	272	25	88	1460	1	498,90
0750 05 0065	65	300	28	98	2025	1	652,25
0750 05 0070	70	330	32	108	2890	1	746,65
0750 05 0075	75	330	32	108	2755	1	799,15
0750 05 0080	80	360	35	126	4000	1	1135,20
0750 05 0085	85	360	35	126	3620	1	1277,25
0750 05 0090	90	390	40	140	5465	1	1571,10
0750 05 0095	95	390	40	140	5250	1	1771,60
0750 05 0100	100	420	44	148	6755	1	2048,05
0750 05 0105	105	420	44	148	6445	1	2114,10
0750 05 0110	110	450	48	166	8500	1	2260,00
0750 05 0115	115	450	48	166	8460	1	2533,30
0750 05 0120	120	490	54	178	10000	1	3481,75

ÖZEL SERİLER (adet ve termin süresi isteyiniz)
SPECIAL SERIES (ask for quantity and delivery terms)

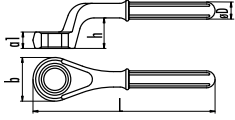
0750 05 0125	125	490	54	178	9900	1	-----
0750 05 0130	130	518	59	196	16000	1	-----
0750 05 0135	135	518	59	196	15900	1	-----
0750 05 0140	140	518	59	196	15800	1	-----
0750 05 0145	145	580	61.8	223	22000	1	-----
0750 05 0150	150	580	61.8	223	21900	1	-----
0750 05 0155	155	580	61.8	223	21800	1	-----
0750 05 0160	160	580	61.8	223	21700	1	-----
0750 05 0165	165	648	67	262	30000	1	-----
0750 05 0170	170	648	67	262	29800	1	-----
0750 05 0180	180	648	67	262	29700	1	-----

0550
Boru Uzatmalı Yıldız Anahtar (mm)
Offset Ring Wrench (mm)

Krom vanadyum, Krom kaplı
 Chrom vanadium, Chrom plated

KOD CODE	mm	L mm	a1 mm	b mm	ØD mm	h mm	g	TL/Ad.
0550 05 0024	24	180	17	37	18.5	30	400	1 99,90
0550 05 0027	27	190	18	42	18.5	33	450	1 119,05
0550 05 0030	30	200	20	46	18.5	34	520	1 142,20
0550 05 0032	32	235	21.5	49	21.2	37	700	1 163,30
0550 05 0036	36	245	23	53.5	21.2	42	830	1 184,75
0550 05 0038	38	270	25	60.5	21.2	43	965	1 213,15
0550 05 0041	41	270	25	60.5	21.2	43	950	1 241,45
0550 05 0046	46	280	26	68	24.2	45	1240	1 288,95
0550 05 0050	50	290	28	74	24.2	47	1410	1 341,15
0550 05 0055	55	300	30	79	24.2	50	1550	1 479,80
0550 05 0060	60	345	32	89	29	50.5	2390	1 520,75
0550 05 0065	65	355	34	98	29	56.5	2730	1 563,80

ÖZEL SERİLER (adet ve termin süresi isteyiniz)
SPECIAL SERIES (ask for quantity and delivery terms)

0550 05 0022	22	180	17	37	18.5	30	400	1	-----
0550 05 0034	34	235	21.5	49	21.2	37	750	1	-----
0550 05 0070	70	365	37	104	29	55	2900	1	-----
0550 05 0075	75	375	40	109	29	57.5	3100	1	-----
0550 05 0080	80	385	43	124	29	59	3900	1	-----
0550 05 0085	85	385	43	124	29	59	3750	1	-----
0550 05 0090	90	410	46	140	29	63	5100	1	-----
0550 05 0095	95	410	46	140	29	63	4950	1	-----
0550 05 0100	100	420	46	150	29	65	4800	1	-----

0551
Döndürme Kolu Borusu
Tubular Handle

Dikişsiz Çelik Boru
 Seamless Steel Pipe

KOD CODE	mm	L mm	Ø mm	g	TL/Ad.
0551 05 0001	22 - 30	460	25	700	1 88,70
0551 05 0002	32 - 41	610	27	1220	1 120,20
0551 05 0003	46 - 55	760	32.2	1880	1 180,20
0551 05 0004	60 - 100	860	38	2975	1 243,20

0600
Kurbağacak Anahtar
Adjustable Wrench

TS 3796
 DIN 3117



IZELTAS YOUTUBE

Yedek parça sayfa 200
 Spare parts page 200

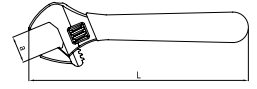

Krom vanadyum, Krom kaplı, PVC izoleli
 Chrom vanadium, Chrom plated, PVC insulated

KOD CODE	L mm	L inch	a mm	g	TL/Ad.
0600 01 1006	160	6"	18	120	5 88,75
0600 01 1008	208	8"	23	230	5 114,90
0600 01 1010	260	10"	28	400	5 148,10
0600 01 1012	308	12"	34	670	5 204,70
0600 01 1015	388	15"	43	1555	1 320,85

0860
Kanca Anahtar (dörtgen uçlu)
Hook Wrench

TS 3798 • DIN 1810

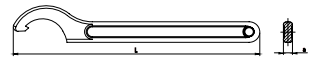

Krom vanadyum, Krom kaplı
 Chrom vanadium, Chrom plated

KOD CODE	mm	L mm	a1 mm	g	TL/Ad.
0860 05 2528	25/28	136	4	50	10 49,05
0860 05 3032	30/32	136	4	50	10 49,05
0860 05 3436	34/36	171	5	95	10 53,05
0860 05 4042	40/42	171	5	95	10 53,05
0860 05 4550	45/50	210	6	160	10 61,50
0860 05 5255	52/55	210	6	160	10 61,50
0860 05 5862	58/62	242	7	270	5 74,15
0860 05 6875	68/75	242	7	270	5 74,15
0860 05 8090	80/90	281	8	400	5 96,80
0860 05 9510	95/100	281	8	400	5 96,80

Ayarlı Montaj Anahtarı
Adjustable Speed Wrench

 **Yedek parça sayfa 200**
Spare parts page 200

Krom vanadyum, Krom kaplı
Chrom vanadium, Chrom plated

KOD CODE	L mm	L inch	a mm	 g		TL/Ad.
0615 01 0200	200	8"	6-22	220	5	143,25

6 ile 22 mm arası **Altı Köşe, Torx, XZN, Ribe, Kare** gibi farklı geometriye sahip cıvataları açabilme imkanı sağlar. Anahtarı civata başından tam olarak çıkarmadan açma ve sıkma hareketi olanağı sağlar. Anahtar sapına özel olarak açılmış 10-13-15 mm altı köşe cıvataları açabilme imkanı sağlar

*Allows to open bolts with different geometry such as **Hexagon, Torx, XZN, Ribe, Square** in sizes from 6 to 22 mm. Enables unbolting and tightening turn without removing the wrench completely from the bolt head. Specially opened 10-13-15 mm holes on the handle, allows to open hexagon bolts.*

**Altı Köşe / Hexagon****Torx®****XZN****Ribe****Kare / Square**

MCD ÇOK NOKTADAN TEMAS PROFİLİ / MCD MULTI CONTACT DRIVE PROFILE



İzeltaş Yeni Jenerasyon Yıldız Anahtar Profili

MCD, Multi Contact Drive (çoklu temas), sıkma performansının geliştirilmesi amacıyla dizayn edilmiştir. Bilgisayar destekli titiz çalışmaların sonucunda geliştirilen MCD, klasik 12 köşe anahtardan çok daha kullanışlı, çok daha güçlüdür.

En önemli özelliği, yıldız kafadaki çoklu temas yüzeyleridir. Bu sayede civata ve somunla maksimum temas sağlanır. Böylece basınç tüm köşelere eşit olarak dağılarak, temas edilen yüzeylerdeki olası hasarlar önlenir, aletin ömrü uzar.

- Yıldız kafadaki yeni profil, düzenli bir dalga şeklindedir. Güç, civatanın köşelerine değil, yan yüzeylerine etki eder (çoklu temas). Basınç daha dengeli dağıldığından temas edilen yüzeylerde ezilme meydana gelmez.
- Tolerans dışı civatalar için de uygundur.
- Civata başlarının köşelerini ezmez.
- Geniş temas alanı, anahtar ömrünü arttırır.
- Bozuk ve deforme olmuş civataları kolayca açar.

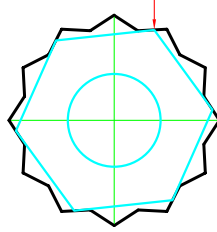

Çoklu Temas / Multi Point Contact

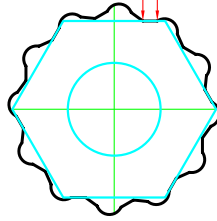

MCD Profil
MCD Profile

IZELTAS New Generation Ring Wrench Profile

MCD (Multi Contact Drive) is designed to improve the driving performance of the ring wrench. MCD, designed through computer aided drafting, transmits more torque and has longer life than conventional 12 edge ring profile.

Multi point contact is the source of effectiveness, where maximum surface area is in touch with fastener flats. Increased contact also maximizes tool's life through decreased pressure on the contact points.

- New profile of the ring wrench is formed of curves. Torque is transmitted through these curves rather than edges. As the stress is balanced between enlarged surfaces, the risk of deformation is minimized.
- It is possible to drive off-tolerance fasteners.
- Does not deform the fastener edges.
- Larger contact area increases tool's life.
- Works well with deformed fasteners.

MONTAJ ANAHTARI / SPEED WRENCH



%100 Daha Hızlı

Yeni tasarlanan montaj anahtarı, 2 kat hızlıncır mekanizması mantığına dayanan çalışma prensibinden alır. Kullanım sırasında, montaj anahtarını civatadan ayırmadan döndürme kolaylığı kullanım hızını arttırırken, civata köşelerine sağlam tutunan anahtar profili güvenli ve kaydırmaz kullanım sağlar.

Uzun Ömür

Bu yeni montaj anahtarı profili, civata ve somunlar ile köşelerinden değil düz yüzeyleri üzerinden temas ederek düzenli tork iletimini sağlarken, gerilimin artmasını da engelleyerek anahtar ömrünün uzamasını sağlar.

- Anahtarı civatadan ayırmadan hızlı kullanım.
- Güvenli tork iletimi ve uzun ömür.

100% Faster

New designed speed wrench takes its 100% faster rotational drive from the ratchet mechanism principle. Rotating the tool without the need for removing from the fastener provides faster usage, while enabling safer and slip-free usage with fully gripping upper and lower jaws.

Longer Tool Life

This new speed wrench profile contacts the fasteners from their flats rather than edges, which provides balanced torque transmission and decreases stress accumulation on the edges increasing the tool life considerably.

- Fast drive without removing the wrench from the fastener.
- Firm torque transmission and longer life.

AYARLI MONTAJ ANAHTARI / ADJUSTABLE SPEED WRENCH



6 ile 22 mm arası altı köşe, torx,yive ,ribe, kare gibi farklı geometriye sahip civataları açabilme imkanı sağlar. Anahtarı civata başından tam olarak çıkarmadan açma ve sıkma hareketi olanağı sağlar. Anahtar sapına özel olarak açılmış 10-13-15 mm altı köşe civataları açabilme imkanı sağlar

This tool is used for all different shapes of bolts between 6 and 22 mm. Contact between the tool and bolt is not removed to loosen and tighten the bolt. With the hexagonal holes in the handle, tool also can be used for 10-13-15mm bolts and nuts.



İZELTAS®

LOKMA VE BİJON ANAHTARLARI

SOCKETS AND RIM WRENCHES

SOCKETS AND
RIM WRENCHES

LOKMA BİJON
ANAHTARI

Lokma Anahtarlar
Socket Wrenches

Lokma Takımları
Socket Wrench Sets

Kovan Anahtarlar
Tubular Socket Wrenches

Bijon Anahtarlar
Rim Wrenches

Tork Anahtarları
Torque Wrenches

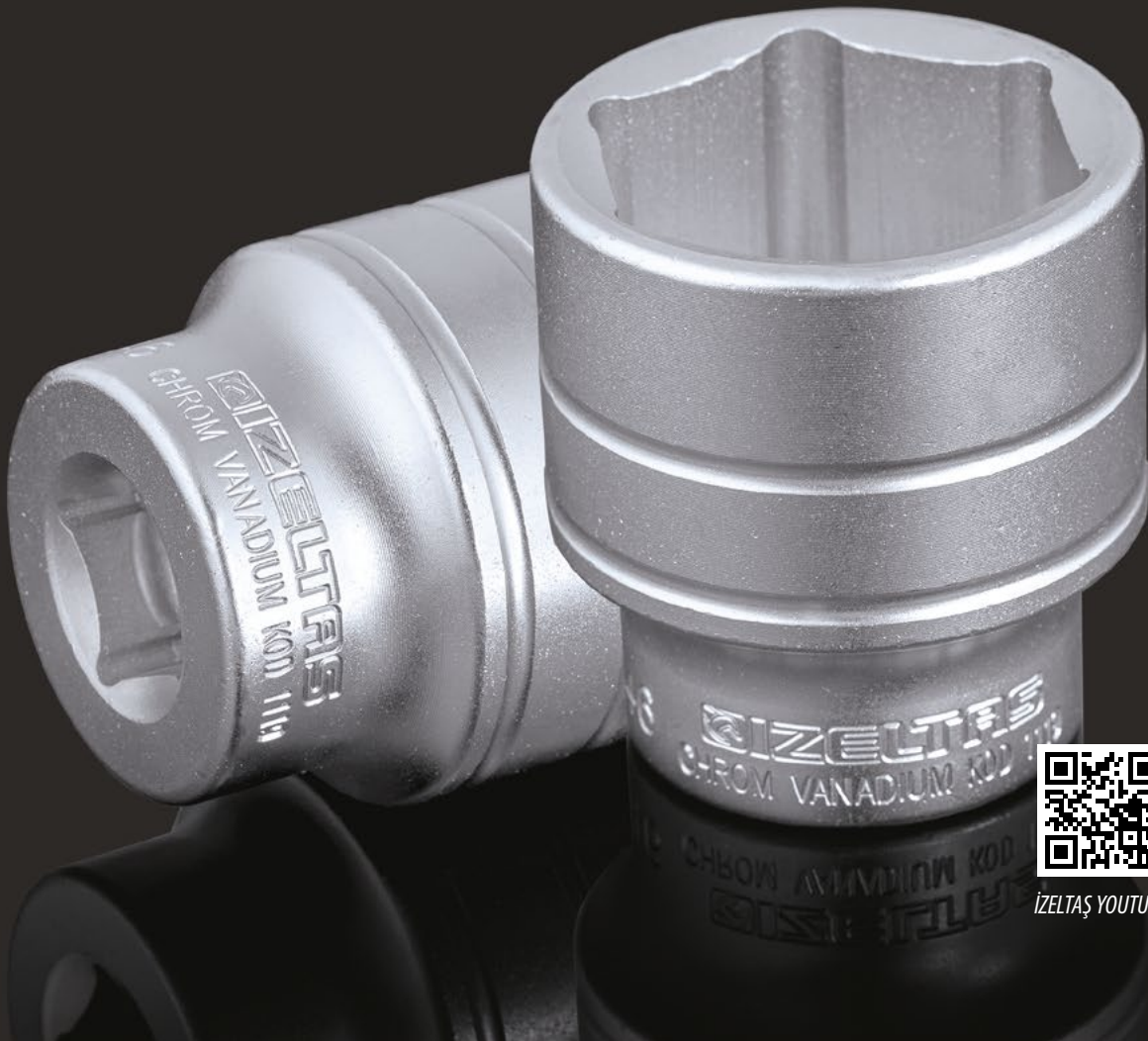

İZELTAS YOUTUBE

Tork (Moment) ve Kuvvet / Torque (Moment) and Force

» Bilindiği üzere kuvvet bir cisme hareketini veren etkidir. Tork ise cismin bir kuvvet etkisinde döndürülmesidir. Bağlantı elemanlarını sıkma işlemlerinde genel olarak yıldız, çatal ya da lokma anahtar gibi çeşitli el aletleri kullanılır. Bu işlem fiziksel olarak işlevsel ve doğru olarak gözüke de vida, civata bağlantısının güvenilirliği açısından doğru bir çalışma şekli değildir. Bir vida-civata bağlantısının çözülmeye karşı en büyük emniyeti teorik olarak hesaplanmış olan tork değeri ile sıkılmasıdır. Bu da ancak çeşitli modern yöntemler ile sağlanabilir. Örneğin; tork anahtarı ile sıkmak, motor tahrikli sıkma işlemleri, ultrason ile sıkmak gibi. Çeşitli uygulamalar tork anahtarı kullanımının daha makul olduğunu göstermiştir.

» As you know, force is the effect which imparts movement to an object. Torque, is rotation of an object under effect of force. Various hand tools like a Philips head screwdriver, for spanner or socket wrench are used to tighten connection elements. While this process appears functional and correct, it is not an appropriate procedure for reliability of the threaded connection. The greatest safety of a threaded connection against loosening is being tightened at a certain torque level theoretically calculated beforehand. This can only be ensured with various modern methods. For example, tightening with a torque wrench, motor-driven tightening or ultrasound supported tightening. Various applications have shown that use of a torque wrench is more appropriate.



Sıkma Torku Nedir ?

» Sıkma torku, kuvvet etkisiyle döndürme kolunun uç kısmındaki anahtar ağzında oluşturulur ve birimi Nm'dir. Bu sıkma torku vida bağlantısında bir ön gerilme yaratır. Sıkma torkunun olması gerekenden düşük olması, zamanla oluşabilecek titreşimler sebebiyle vida-civata bağlantısında gevşeme/çözülmeye yol açabilir. Ön gerilme kuvveti fazlaca oluşan bağlantılarda ise parçalara zarar verebilir, aynı zamanda vida üzerindeki dişlerde meydana gelecek aşınmalar bağlantıyı çözülemeye kılabilir.

What is Tightening Torque ?

» Tightening torque is generated at the wrench tip at the terminus of the rotating lever under the effect of force, and its unit is Nm. This tightening torque creates a pre-tension on the threaded connection. Tightening torque being lower than what is necessary can cause the threaded connection to loosen/unravel due to vibrations that might occur over time. On the other hand, pre-tension force being over what is necessary can cause damage on the connection parts, as well as causing the threads on the connection piece to wear off or causing the connection become non-severable.

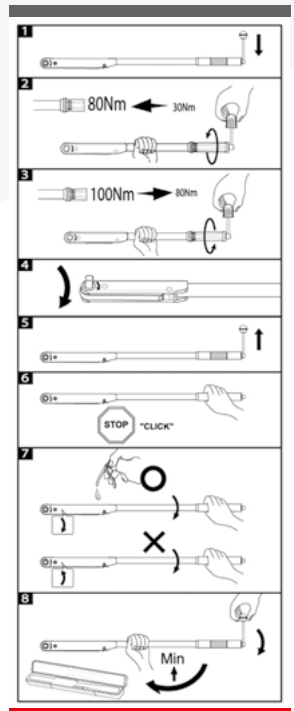

Tork Anahtarlarının Doğru Kullanımı

- » Tork anahtarı ile çalışılırken dikkat edilmesi gereken bazı hususlar bulunmaktadır. Bunlardan başlıcaları;
- Hangi tip tork anahtarı olursa olsun döndürme yönünün aksine kuvvet uygulanmaması gereklidir.
 - Cırcır anahtarlar gibi tork anahtarlarının da sökme işlemi için kullanılmaması gerekir.
 - Klik sesli modellerde klik sesi duyulduğu anda ayarlanmış tork değerine ulaşılmış demektir, daha fazla kuvvet uygulanmamalıdır.
 - Gövdesi hasar görmüş, mekanizması bozulmuş tork anahtarlarını kullanmaya devam etmeyiniz.
 - Kuvvet, tork anahtarının sap kısmından uygulanmalıdır.
 - Kullanımdan sonra nemden ve kirden korumak için her zaman kutusunda muhafaza ediniz.
 - Her kullanımdan sonra tork anahtarındaki yükü "0 Nm" konumuna getiriniz.
 - Tork anahtarlarını kendi başınıza tamir etmeye çalışmayınız.



Tork Anahtarlarının Kalibrasyonu

- » Tork anahtarlarının doğru çalışması ve bağlantıların sağlıklı sıkılabilmesi için kalibrasyon işlemi büyük önem arz etmektedir. TS EN ISO 6789-1 Standardına göre tork anahtarlarının ilk kullanımdan itibaren geçerli olmak üzere 12 aylık bir periyotta veya her 5000 kullanımlık çevrim sonunda kalibre edilmesi önerilmektedir.

Calibration Of Torque Wrenches

- » Calibration process carries great importance for torque wrenches to function correctly and be able to tighten connections in a healthy fashion. TS EN ISO 6789-1 Standard stipulates torque wrenches should be calibrated with 12 month periods or after each cycle of 5000 uses starting from the first use.

Correct Use Of Torque Wrenches

- » There are some important points that must be kept in mind when working with a torque wrench. Some of these include the following.
- No matter which type of torque wrench is used, force should not be applied at the opposite of rotating direction.
 - Torque wrenches like ratchet wrenches should not be used to loosen connections.
 - In models with click sound option, the click indicates the set torque value is achieved and further force should not be applied from then on.
 - Do not continue using torque wrenches with a damaged body or mechanism.
 - Force should be applied at the handle part of the torque wrench.
 - The tool should always be kept in its box after use to protect against moisture and dirt.
 - The load set of the torque wrench should be adjusted to "0 Nm" after each use.
 - Please do not attempt to repair torque wrenches on your own.



1/2" ALTI KÖŞELİ LOKMA ANAHTAR/SOCKET WRENCH 6 POINTS

Nikel üzeri krom
kaplama ile
korozyon
direncinde üst
seviye koruma
Corrosion protection
with nickel over
chrome plating

Yüksek dayanım için
üst toleranslarda
tasarım
Improved durability
with upper tolerance
thickness

En uygun temas
yüzeyi için hassas
dövülmüş
altı köşe ağızlar
Precise forged hex
shape for best
contact area



Bilya stoplama yuvalı
hassas işlenmiş kare kanal
Precise machined square
adapter with ball stopper
Groove

Yüksek mukavemetli
alaşımli sıcak
dövme çeliği
High strength alloyed
forged steel

Extra sürtünme
kabiliyeti için tırtıklı
tasarım
Extra friction capability
with knurled design

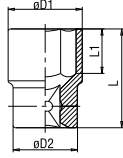

1107
1/4" Altı Köşe Lokma Anahtar (mm)
Socket Wrench 6 Points (mm)

 TS ISO 2725 -1
 DIN 3124

1/4"

 Krom vanadyum, Krom kaplı, Polisajlı
Chrom vanadium, Chrom plated, Polished

KOD CODE	mm	Ø D1 mm	Ø D2 mm	L mm	L1 mm	g	TL/Ad.
1107 06 0004	4	6.8	11.8	25	4	10	5,50
1107 06 0045	4.5	7.4	11.8	25	5	10	5,50
1107 06 0005	5	8	11.8	25	6	10	5,50
1107 06 0055	5.5	8.5	11.8	25	6	10	5,50
1107 06 0006	6	9.2	11.8	25	7	10	5,50
1107 06 0007	7	10.8	11.8	25	7	10	5,50
1107 06 0008	8	11.9	11.8	25	8	10	5,50
1107 06 0009	9	12.9	12.8	25	8	15	5,80
1107 06 0010	10	14.3	14.3	25	9	20	5,80
1107 06 0011	11	15.8	15.8	25	9	20	7,40
1107 06 0012	12	16.8	16.8	25	9	25	7,40
1107 06 0013	13	17.8	17.8	25	9	30	8,20

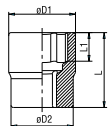
1207
1/4" Sekiz Köşe Lokma Anahtar (mm)
Socket Wrench 8 Points (mm)

 TS ISO 2725 -1
 DIN 3124

1/4"

 Krom vanadyum, Krom kaplı, Polisajlı
Chrom vanadium, Chrom plated, Polished

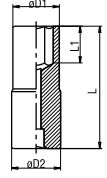
KOD CODE	mm	Ø D1 mm	Ø D2 mm	L mm	g	TL/Ad.
★1207 06 8008	8	12.2	12.2	25	15	7,65
★1207 06 8010	10	14.7	14.7	25	25	9,00

1107
1/4" Altı Köşe Derin Lokma Anahtar (mm)
Deep Socket Wrench 6 Points (mm)

1/4"

 Krom vanadyum, Krom kaplı, Polisajlı
Chrom vanadium, Chrom Plated, Polished

KOD CODE	mm	Ø D1 mm	Ø D2 mm	L mm	L1 mm	g	TL/Ad.
1107 06 4004	4	6.8	11.8	50	6	10	10,80
1107 06 4005	5	8	11.8	50	7	20	10,80
1107 06 4055	5.5	8.7	11.8	50	9	20	10,80
1107 06 4006	6	9.2	11.8	50	9	25	12,10
1107 06 4007	7	10.8	11.8	50	15	25	12,10
1107 06 4008	8	11.8	11.8	50	15	25	12,10
1107 06 4009	9	13	13	50	15	30	12,10
1107 06 4010	10	14.5	14.5	50	15	40	12,10
1107 06 4011	11	15.8	15.8	50	21	45	13,00
1107 06 4012	12	16.8	16.8	50	21	50	13,00
1107 06 4013	13	17.8	17.8	50	21	55	13,00

1107
1/4" Derin Lokma Anahtar Set (14 parça, mm)
Socket Wrench Set Long Type (14 pcs, mm)

1/4"

KOD CODE	LOKMA LAR Sockets	AVADANLIK LAR Accessories	g	TL/Ad.
1107 00 6014	4-5-5.5-6 7-8-9-10 11-12-13 Altı Köşe Derin Lokma Deep Socket Wrench 6 Points	1/4" Cırcır Kol Ratchet Handle 1/4" Ara Kol Extension Bar 50 mm 1/4" Ara Kol Extension Bar 100 mm	1005	14 256,90

Havalı aletler ile kullanmayınız / Do not use with power-tools

 (★) İşaretili olan ürünler stoklarla sınırlıdır.
 Limited with stocks.

1107

1/4" Lokmalı Allen Uç Hexagonal Bit Socket Wrench



1/4"

Krom vanadyum, Krom Kaplı
Chrom vanadium, Chrom Plated

KOD CODE	mm	L mm	g		TL/Ad.
1107 06 1125	2.5	37	13	10	9,00
1107 06 1103	3	37	13	10	9,00
1107 06 1104	4	37	15	10	9,00
1107 06 1105	5	37	15	10	9,00
1107 06 1106	6	37	15	10	9,00
1107 06 1107	7	37	16	10	10,60
1107 06 1108	8	37	17	10	10,60
1107 06 1110	10	37	19	10	12,80

1107

1/4" Lokmalı Star Delikli (Torx®) Uç Tamper Resistant Torx Bit Socket Wrench



1/4"

Krom vanadyum, Krom Kaplı
Chrom vanadium, Chrom Plated

KOD CODE		L mm	g		TL/Ad.
1107 06 1308	TR8	37	13	10	10,80
1107 06 1309	TR9	37	13	10	10,80
1107 06 1310	TR10	37	13	10	10,80
1107 06 1315	TR15	37	14	10	10,80
1107 06 1320	TR20	37	14	10	10,80
1107 06 1325	TR25	37	14	10	10,80
1107 06 1327	TR27	37	14	10	10,80
1107 06 1330	TR30	37	15	10	10,80
1107 06 1340	TR40	37	16	10	12,65

1107

1/4" Lokmalı Star (Torx®) Uç Torx Bit Socket Wrench



1/4"

Krom vanadyum, Krom Kaplı
Chrom vanadium, Chrom Plated

KOD CODE		L mm	g		TL/Ad.
1107 06 1208	T8	37	12	10	9,25
1107 06 1209	T9	37	12	10	9,25
1107 06 1210	T10	37	13	10	9,25
1107 06 1215	T15	37	14	10	9,25
1107 06 1220	T20	37	14	10	9,25
1107 06 1225	T25	37	14	10	9,25
1107 06 1227	T27	37	14	10	9,25
1107 06 1230	T30	37	15	10	9,25
1107 06 1240	T40	37	16	10	9,25

1107

1/4" Lokmalı Düz Uç Slotted Bit Socket Wrench



1/4"

Krom vanadyum, Krom Kaplı
Chrom vanadium, Chrom Plated

KOD CODE		L mm	g		TL/Ad.
1107 06 1403	3	37	13	10	9,00
1107 06 1435	3.5	37	14	10	9,00
1107 06 1404	4	37	14	10	9,00
1107 06 1445	4.5	37	14	10	9,00
1107 06 1455	5.5	37	15	10	9,00
1107 06 1465	6.5	37	15	10	9,00
1107 06 1407	7	37	16	10	9,00
1107 06 1408	8	37	16	10	10,90
1107 06 1410	10	37	17	10	11,80

1107
1/4" Lokmalı Yıldız Uç
Phillips Bit Socket Wrench

1/4"

 Krom vanadyum, Krom Kaplı
Chrom vanadium, Chrom Plated

KOD CODE	+	L mm	g	□	TL/Ad.
1107 06 1501	Ph 1	37	14	10	9,00
1107 06 1502	Ph 2	37	14	10	9,00
1107 06 1503	Ph 3	37	15	10	9,00
1107 06 1504	Ph 4	37	16	10	9,00

1107
1/4" Bits Uçlu Lokma Set (42 Parça)
Bit Socket Wrench Set (42 Pcs)

1/4"

KOD CODE	İÇERİK CONTENTS	□	TL/Ad.
1107 00 1042	1/4" Lokmalı Star Torx® Uçlar Torx® Bit Socket T8-T9-T10-T15-T20-T25-T27-T30-T40	42	521,15
	1/4" Lokmalı Star Delikli Torx® Uçlar Tamper Resistant Torx® Bit Socket Wrench TR8-TR9-TR10-TR15-TR20-TR25-TR27 TR30-TR40		
	1/4" Lokmalı Allen Uçlar Hexagonal Bit Socket Wrench 2.5-3-4-5-6-7-8-10		
	1/4" Lokmalı Düz Uç Slotted Bit Socket Wrench 3-3.5-4-4.5-5.5 6.5-7-8-10		
	1/4" Lokmalı Yıldız Uç Phillips Bit Socket Wrench Ph1-Ph2-Ph3-Ph4		
	1/4" Cırcır kolu Ratchet Handle		
	1/4" Ara Kol Extension Bar 100 mm		
1/4" Lokma Tornavida Adaptörü Spindle Handle			

Havalı aletler ile kullanmayınız / Do not use with power-tools

1507
1/4" Ara Kol
Extension Bar

 TS ISO 3316
 DIN 3123

1/4"

 Krom vanadyum, Krom kaplı, Polisajlı
Chrom vanadium, Chrom plated, Polished

KOD CODE	L mm	g	□	TL/Ad.
1507 06 0050	50	25	5	13,50
1507 06 0100	100	45	5	14,65

1507
1/4" Ara Kol Flexible
Flexible Extension

**YENİ
NEW**

 Krom vanadyum, Krom kaplı
Chrom vanadium, Chrom plated
1/4"

KOD CODE	L mm	g	□	TL/Ad.
1507 06 3150	150	70	5	55,50

1507
1/4" Mafsal
Universal Joint

 TS ISO 1174
 DIN 3123

1/4"

 Krom vanadyum, Krom kaplı, Polisajlı
Chrom vanadium, Chrom plated, Polished

KOD CODE	L mm	g	□	TL/Ad.
1507 06 0038	38	25	5	24,75

1507
1/4" T Kol
Sliding T - Handle

 TS ISO 3315
 DIN 3122

1/4"

 Krom vanadyum, Krom kaplı, Polisajlı
Chrom vanadium, Chrom plated, Polished

KOD CODE	L mm	g	□	TL/Ad.
1507 06 4115	115	45	5	22,55

 (★) İşaretli olan ürünler stoklarla sınırlıdır.
 Limited with stocks.

1507**1/4" Cırcır Kolu**
Ratchet Wrench

TS ISO 3315

**1/4"****Krom vanadyum, Krom kaplı, Polisajlı**
Chrom vanadium, Chrom plated, Polished

KOD CODE	L mm	g	TL/Ad.
1507 06 2140	140	140	5 96,85

1507**1/4" Mandallı Cırcır Kolu**
Ratchet With Latch

TS ISO 3315

**YENİ
NEW****1/4"****Krom vanadyum, Krom kaplı, Polisajlı**
Chrom vanadium, Chrom plated, Polished

KOD CODE	L mm	g	TL/Ad.
1507 06 6140	140	140	5 128,70

1507**1/4" Mafsallı Cırcır Kolu (72 Diş)**
*Swivel Head Ratchet (72 Teeth)***YENİ
NEW****1/4"****Krom vanadyum, Krom kaplı, Polisajlı**
Chrom vanadium, Chrom plated, Polished

KOD CODE	L mm	g	TL/Ad.
1507 06 2150	150	130	5 298,35

1507**1/4" Lokma/Bits Tutuculu Cırcır Kolu (72 Diş)**
*Socket/Bit Holder mini Ratchet (72 Teeth)***YENİ
NEW****1/4"****Krom vanadyum, Krom kaplı, Polisajlı**
Chrom vanadium, Chrom plated, Polished

KOD CODE	L mm	g	TL/Ad.
1507 06 2110	110	100	5 187,20

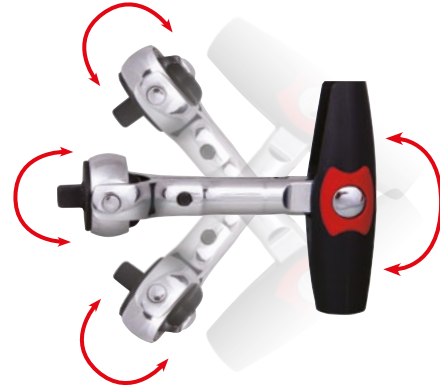
1507**1/4" Mafsallı T Kol Cırcır (72 Diş)**
*Swivel Head, T Handle Ratchet (72 Teeth)***YENİ
NEW****1/4"****Krom vanadyum, Krom kaplı, Polisajlı**
Chrom vanadium, Chrom plated, Polished

KOD CODE	L mm	g	TL/Ad.
1507 06 7115	115	110	5 286,65

1507

1/4" Lokma Adaptörü
Adapter

TS ISO 3316
DIN 3123



1/4"

Krom vanadyum, Krom kaplı, Polisajlı
Chrom vanadium, Chrom plated, Polished

KOD CODE	inch	g		TL/Ad.
1507 06 0004	1/4"Fx3/8"M	20	5	16,25

1507

1/4" Derin Lokma Tornavida Adaptörü
Spindle Handle

TS ISO 3315
DIN 3122

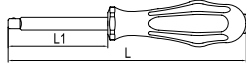

1/4"

Krom vanadyum, Krom kaplı, Polisajlı, Selüloz Asetat Saplı
Chrom vanadium, Chrom plated, Polished, Cellulose Acetate Handle

KOD CODE	L mm	L1 mm	g		TL/Ad.
1507 06 4080	150	65	100	10	26,65

1107

1/4" Bits Tutucu Lokma (Mıknatıslı)
Bit Holder Socket



1/4"

Krom vanadyum
Chrom vanadium

KOD CODE	Inch	g		TL/Ad.
1107 06 5010	1/4" F - 1/4" F	15	5	18,55

1107

1/4" Altı Köşe Lokma Anahtar Takımı (15 parça, mm)
Socket Wrench Set 6 Points (15 pcs, mm)



1/4"

KOD CODE	LOKMALAR Sockets	AVADANLIKLAR Accessories	g		TL/ Ad.
1107 00 6015	4 - 5 - 6 7 - 8 - 9 - 10 11 - 12 - 13 Altı Köşe Six Points	1/4" Cırcır kolu Ratchet Handle 1/4" Mafsal Universal Joint 1/4" T Kol Sliding T Handle 1/4" Ara Kol Extension Bar 50 mm 1/4" Ara Kol Extension Bar 100 mm	960	15	234,40

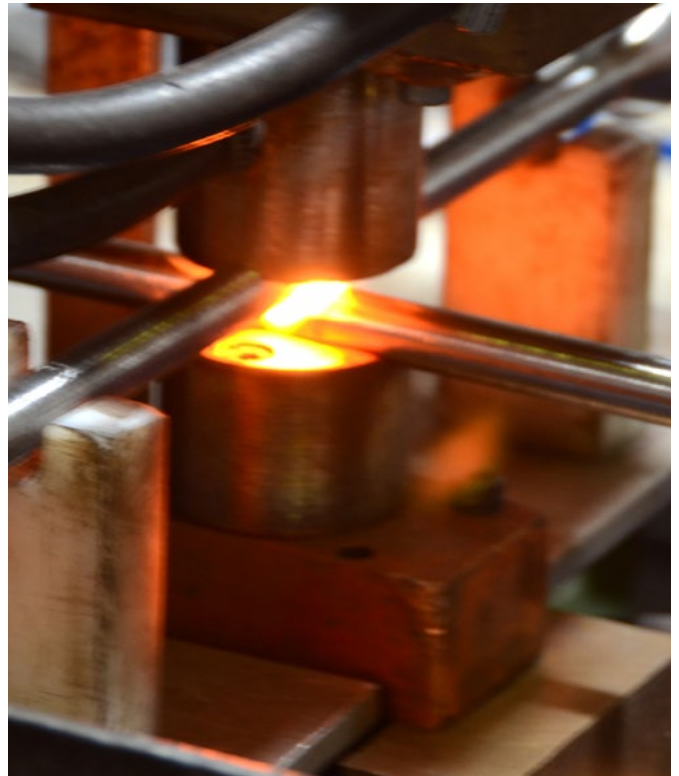

Havali aletler ile kullanmayınız / Do not use with power-tools

1110

3/8" Altı Köşe Lokma Anahtar (mm)
Socket Wrench 6 Points (mm)

TS ISO 2725 - 1
DIN 3124

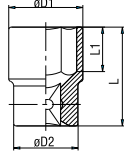

3/8"

Krom vanadyum, Krom kaplı, Polisajlı
Chrom vanadium, Chrom plated, Polished

KOD CODE	mm	σ D1 mm	σ D2 mm	L mm	L1 mm	g	TL/Ad.
1110 06 0006	6	9.8	17.8	27	9	25	10, 14,35
1110 06 0007	7	10.8	17.8	27	9	25	10, 14,35
1110 06 0008	8	12	17.8	27	9	25	10, 14,35
1110 06 0009	9	13.2	17.8	27	9	25	10, 14,35
1110 06 0010	10	14.5	17.8	27	9	25	10, 14,35
1110 06 0011	11	15.8	17.8	27	9	30	10, 14,35
1110 06 0012	12	16.8	17.8	27	9	30	10, 14,35
1110 06 0013	13	17.8	16.8	27	9	30	10, 15,35
1110 06 0014	14	19.6	17.5	29	11	35	10, 15,35
1110 06 0015	15	20.8	18	29	11	45	10, 15,35
1110 06 0016	16	21.8	19	29	11	45	10, 16,05
1110 06 0017	17	23.4	20	29	11	55	10, 16,05
1110 06 0018	18	24.7	21	29	13	60	10, 16,05
1110 06 0019	19	25.8	22	29	13	65	10, 18,50
1110 06 0021	21	27.8	24	32	13	80	10, 20,15
1110 06 0022	22	29.7	26	32	15	85	10, 21,55
1110 06 0023	23	29.7	26	32	15	90	10, 21,55

1110

3/8" Buji Lokma Anahtar (Lastikli)
Spark Plug Socket with Rubber

TS ISO 2725 - 1



3/8"

Krom vanadyum, Krom kaplı, Polisajlı
Chrom vanadium, Chrom plated, Polished

KOD CODE	mm	L mm	g	TL/Ad.
1110 06 9208	21	70	145	10, 28,05

1510

3/8" Cırcır Kolu
Ratchet Handle

TS ISO 3315
DIN 3122



3/8"

Krom vanadyum, Krom kaplı, Polisajlı
Chrom vanadium, Chrom plated, Polished

KOD CODE	L mm	g	TL/Ad.
1510 06 0200	200	295	5, 155,75

1510

3/8" Ara Kol
Extension Bar

TS ISO 3316
DIN 3123



3/8"

Krom vanadyum, Krom kaplı, Polisajlı
Chrom vanadium, Chrom plated, Polished

KOD CODE	L mm	g	TL/Ad.
1510 06 0075	75	75	5, 24,85
1510 06 0150	150	145	5, 37,65

1510

3/8" Mafsal
Universal Joint

TS ISO 3316
DIN 3123



3/8"

Krom vanadyum, Krom kaplı, Polisajlı
Chrom vanadium, Chrom plated, Polished

KOD CODE	L mm	g	TL/Ad.
1510 06 0056	56.5	60	5, 40,40

1510

3/8" T Kol
Sliding T - Handle

TS ISO 3315
 DIN 3122

3/8"

Krom vanadyum, Krom kaplı, Polişajlı
Chrom vanadium, Chrom plated, Polished

KOD CODE	L mm	g	TL/Ad.
1510 06 1200	200	180	5 58,10

1510

3/8" Lokma Adaptörü
Adapter

TS ISO 3316
 DIN 3123

3/8"

Krom vanadyum, Krom kaplı, Polişajlı
Chrom vanadium, Chrom plated, Polished

KOD CODE	inch	g	TL/Ad.
1510 06 0007	3/8"Fx1/2"M	45	5 27,70

1510

3/8" Mafsallı Kol
Flexible Handle

TS ISO 3315
 DIN 3122

3/8"

Krom vanadyum, Krom kaplı, Polişajlı
Chrom vanadium, Chrom plated, Polished

KOD CODE	L mm	g	TL/Ad.
★1510 06 0215	215	310	5 86,30

Havali aletler ile kullanmayınız / Do not use with power-tools

1110

3/8" Altı Köşe Lokma Anahtar Takımı (19 parça, mm)
6 Points Socket Wrench Set (19 Pcs, mm)

3/8"

KOD CODE	LOKMALAR Sockets	AVADANLIKLAR Accessories	g	TL/Ad.
		3/8" Cırcır Kolu Ratchet Handle		
		3/8" Mafsallı Universal Joint		
	6 - 7 - 8 - 9 10 - 11 - 12 13 - 14 - 17 19 - 21 - 23			
1110 00 6019	Altı Köşe Six Points 20.8 Buji Lokma Lastikli Altı Köşe Spark Plug Socket With Rubber	3/8" T Kol Sliding T Handle	1089	19 552,20
		3/8" Ara Kol Extension Bar 75 mm		
		3/8" Ara Kol Extension Bar 150 mm		

(★) İşaretili olan ürünler stoklarla sınırlıdır.
 Limited with stocks.

1/2" Lokma Anahtar Sehпасı (145 Parça) Display Frame for Sockets (145 Pcs)

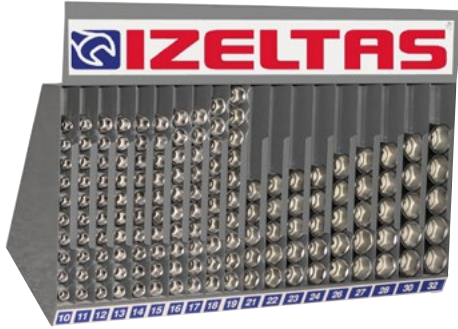

1/2"

KOD CODE	İÇERİK CONTENTS	g	TL/Ad.
	Dolu/Full		
	10-11-12 13-14-15 16-17-18-19 10 adet /10 Pcs		
1113 00 6145		18.236	1 3853,00
	21-22-23 24-26-27 28-30-32 5 Adet / 5 Pcs		

1/2" Altı Köşe Lokma Anahtar (mm) Socket Wrench 6 Points (mm)

TS ISO 2725 -1
DIN 3124



1/2"

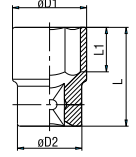

Krom vanadyum, Krom kaplı
Chrom vanadium, Chrom plated

KOD CODE	mm	ø D1 mm	ø D2 mm	L mm	L1 mm	g	TL/Ad.
1113 06 1008	8	14	22	38	7	55	10 16,60
1113 06 1009	9	14.1	22	38	7	55	10 16,60
1113 06 1010	10	15.4	22	38	8	55	10 20,60
1113 06 1011	11	16.6	22	38	8	60	10 20,60
1113 06 1012	12	17.8	22	38	9	60	10 20,60
1113 06 1013	13	19	22	38	10	65	10 22,15
1113 06 1014	14	20.4	22	38	11	65	10 22,15
1113 06 1015	15	21.6	22	38	11	65	10 22,15
1113 06 1016	16	22.9	22	38	11	70	10 23,20
1113 06 1017	17	24	22	38	12	70	10 23,20
1113 06 1018	18	25.4	23	38	13	75	10 23,20
1113 06 1019	19	26.6	23	38	13	75	10 24,25
1113 06 1020	20	28	24	38	13	80	10 24,25
1113 06 1021	21	29.2	24	38	13	85	5 24,25
1113 06 1022	22	30.4	26	38	15	95	5 24,25
1113 06 1023	23	31.2	28	38	15	100	5 25,25
1113 06 1024	24	32.9	28	38	17	115	5 25,25
1113 06 1025	25	33.2	29	42	17	125	5 25,25
1113 06 1026	26	34	30	42	17	135	5 25,25
1113 06 1027	27	36.6	30	42	19	140	5 29,00
1113 06 1028	28	37.5	30	42	20	160	5 29,00
1113 06 1029	29	39.5	32	42	21	170	5 30,50
1113 06 1030	30	40	32	44	21	180	5 30,50
1113 06 1032	32	43	34	44	23	190	5 31,75



1114

1/2" On İki Köşe Lokma Anahtar (mm) Socket Wrench 12 Points (mm)

TS ISO 2725 - 1
DIN 3124



1/2"

Krom vanadyum, Krom kaplı
Chrom vanadium, Chrom plated

KOD CODE	Ø mm	ø D1 mm	ø D2 mm	L mm	L1 mm	g	TL/Ad.
1114 06 1010	10	15	23.3	38	8	60	23,05
1114 06 1011	11	16.4	23.3	38	8	60	23,05
1114 06 1012	12	17.8	23.3	38	9	60	23,05
1114 06 1013	13	19	23.3	38	10	60	24,95
1114 06 1014	14	20.4	23.3	38	11	60	24,95
1114 06 1015	15	21.6	23.3	38	11	65	24,95
1114 06 1016	16	22.9	24	38	11	70	26,00
1114 06 1017	17	24	22.5	38	12	70	26,00
1114 06 1018	18	25.2	23	38	13	70	26,00
1114 06 1019	19	26.8	23	38	13	75	27,25
1114 06 1020	20	28	23	38	13	80	27,25
1114 06 1021	21	29.2	23	38	13	80	27,25
1114 06 1022	22	30.2	24	40	15	95	27,25
1114 06 1023	23	31.4	25	40	15	100	28,40
1114 06 1024	24	32.6	26	42	17	105	28,40
1114 06 1026	26	35.3	28	42	17	135	29,65
1114 06 1027	27	36.6	28	42	19	135	33,90
1114 06 1028	28	37.8	30	42	20	155	33,90
1114 06 1030	30	40	30	44	21	165	35,60
1114 06 1032	32	42.5	30	44	23	180	37,35



Havali aletler ile kullanmayınız / Do not use with power-tools

1413

1/2" On İki Köşe Lokma Anahtar (SAE) Socket Wrench 12 Points (SAE)



1/2"

Krom vanadyum, Krom kaplı
Chrom vanadium, Chrom plated

KOD CODE	Ø inch	ø D1 mm	ø D2 mm	L mm	L1 mm	g	TL/Ad.
1413 06 1008	5/16"	13.2	21.8	37	6	45	27,00
1413 06 1095	3/8"	15	21.8	37	8	50	27,00
1413 06 1010	7/16"	16.4	23.3	37	9	60	27,95
1413 06 1011	15/32"	18	23.3	37	9	60	27,95
1413 06 1012	1/2"	19	23.3	37	9	60	29,05
1413 06 1013	9/16"	20.4	23.3	37	11	60	30,10
1413 06 1014	19/32"	21.6	23.3	37	11	65	30,10
1413 06 1015	5/8"	23.1	22	38	11	70	30,40
1413 06 1016	11/16"	24.5	22.5	38	11	70	31,45
1413 06 1017	3/4"	26.8	23	38	13	75	31,75
1413 06 1020	25/32"	28	23	38	13	75	32,85
1413 06 1021	13/16"	28.6	23	38	13	80	32,85
1413 06 1022	7/8"	30.2	24	40	15	90	32,85
1413 06 1024	15/16"	32.6	26	42	17	115	34,30
1413 06 1025	1"	35	28	42	17	130	34,30
1413 06 1027	1 1/16"	36.6	28	42	19	135	44,95
1413 06 1029	1 1/8"	38.8	30	42	19	170	44,95
1413 06 1030	1 3/16"	40	29.5	44	20	170	44,95
1413 06 1032	1 1/4"	42.5	30	44	22	185	44,95

1113

1/2" Buji Lokma Anahtar (Lastikli) Spark Plug Socket with Rubber



1/2"

Krom vanadyum, Krom kaplı, Polijahlı
Chrom vanadium, Chrom plated, Polished

KOD CODE	Ø mm	L mm	g	TL/Ad.
1113 06 9160	16	70	80	32,65
1113 06 9208	21	70	155	39,10

(*) İşaretili olan ürünler stoklarla sınırlıdır.
Limited with stocks.

1108

1/2" Altı Köşe Derin Lokma Anahtar (mm)
Deep Socket Wrench 6 Points (mm)

TS ISO 2725 - 1
DIN 3124



1/2"

Krom vanadyum, Krom kaplı
Chrom vanadium, Chrom plated

KOD CODE	mm	ØD1 mm	ØD2 mm	L mm	L1 mm	g	TL/Ad.	
1108 06 0010	10	15,2	22	75	6	110	10	43,15
1108 06 0011	11	16,7	24	75	7	110	10	43,15
1108 06 0012	12	18	24	75	8	110	10	43,15
1108 06 0013	13	19	24	75	8	120	10	46,25
1108 06 0014	14	20,5	24	75	10	120	10	46,25
1108 06 0015	15	21,7	24	75	10	140	10	46,25
1108 06 0016	16	22	25,5	75	10	140	10	48,45
1108 06 0017	17	24	25,5	75	10	140	10	48,45
1108 06 0018	18	25,5	25,5	75	12	150	10	48,45
1108 06 0019	19	26	26,7	75	12	150	10	50,65

1108

1/2" Altı Köşe Derin Lokma Anahtar Takımı (10 parça mm)
Deep Socket Set (10 pcs. mm)



1/2"

KOD CODE	L mm	g	TL/Ad.
1108 00 6010	10-11-12-13-14-15 16-17-18-19	1290	10
			464,20

1113

1/2" Star (Torx®) Lokma Anahtar
Star Torx® Socket Wrench



1/2"

Krom vanadyum, Krom kaplı
Chrom vanadium, Chrom plated

KOD CODE	Ø D1 mm	Ø D2 mm	L mm	L1 mm	g	TL/Ad.		
1113 06 0210	E10	13.2	23.8	37	7.5	60	10	22,10
1113 06 0212	E12	15	23.8	37	9	65	10	22,10
1113 06 0214	E14	16.4	23.8	37	10	65	10	22,10
1113 06 0216	E16	18.8	23.8	37	11	70	10	22,10
1113 06 0218	E18	20.5	23.8	39	12.5	75	10	22,10
1113 06 0220	E20	23	23.8	39	14	75	10	24,85

1113

1/2" Star (Torx®) Lokma Anahtar Takımı (7 parça)
Star Torx® Socket Wrench Set (7 Pcs)



1/2"

KOD CODE	İÇERİK CONTENTS	g	TL/Ad.
1113 00 6007	Star Lokma / Star Socket E10 - E12 - E14 - E16 - E18 - E20 125 mm ara kol / Extension Bar	1075	7
			178,20

1113
1/2" Lokmalı Allen Uç
Hexagonal Bit Socket Wrench

1/2"

 Krom vanadyum, Krom kaplı
Chrom vanadium, Chrom plated

KOD CODE	mm	L mm	g	TL/Ad.	
1113 06 1105	5	60	70	10	28,05
1113 06 1106	6	60	70	10	28,05
1113 06 1107	7	60	75	10	28,05
1113 06 1108	8	60	75	10	28,05
1113 06 1110	10	60	85	10	32,00
1113 06 1112	12	60	100	10	32,00
1113 06 1114	14	60	115	10	32,00
1113 06 4105	5	100	90	10	31,90
1113 06 4106	6	100	90	10	31,90
1113 06 4107	7	100	90	10	31,90
1113 06 4108	8	100	95	10	31,90
1113 06 4110	10	100	105	10	36,90
1113 06 4112	12	100	145	10	36,90
1113 06 4114	14	100	155	10	44,50
1113 06 4117	17	100	200	10	59,45

1113
1/2" Lokmalı Star (Torx®) Uç
Star (Torx®) Bit Socket Wrench

1/2"

 Krom vanadyum, Krom kaplı
Chrom vanadium, Chrom plated

KOD CODE	☆	L mm	g	TL/Ad.	
1113 06 1220	T20	60	70	10	34,60
1113 06 1225	T25	60	70	10	34,60
1113 06 1227	T27	60	70	10	34,60
1113 06 1230	T30	60	70	10	34,60
1113 06 1240	T40	60	70	10	34,60
1113 06 1245	T45	60	70	10	34,60
1113 06 1250	T50	60	75	10	34,60
1113 06 1255	T55	60	80	10	34,60
1113 06 1260	T60	60	100	10	34,60
1113 06 4220	T20	100	78	10	37,65
1113 06 4225	T25	100	79	10	37,65
1113 06 4227	T27	100	80	10	37,65
1113 06 4230	T30	100	80	10	37,65
1113 06 4240	T40	100	80	10	37,65
1113 06 4245	T45	100	82	10	37,65
1113 06 4250	T50	100	82	10	37,65
1113 06 4255	T55	100	100	10	37,65
1113 06 4260	T60	100	134	10	37,65

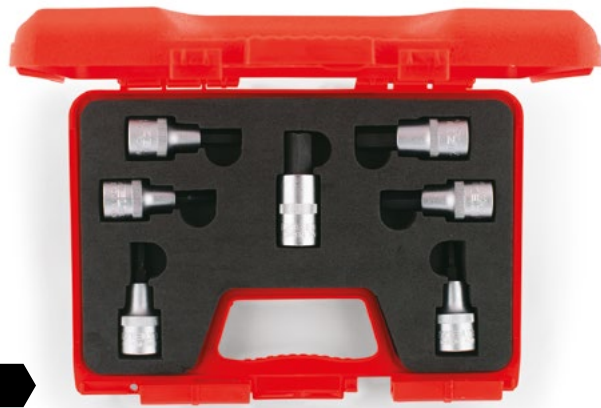
1113
1/2" Lokmalı Allen Uç Takımı (60 mm, 7 Parça)
Hexagonal Bits Socket Wrench Set (60 mm, 7 Pcs)

1/2"

KOD CODE	İÇERİK CONTENTS	g	TL/Ad.	
1113 00 1107	Allen Uçlar 60mm Hex Bit Socket 5-6-7-8-10-12-14	1040	7	208,20

1113
1/2" Lokmalı Torx® Uç Takımı (60 mm, 9 parça)
Torx® Bits Socket Wrench Set (60 mm, 9 Pcs)

1/2"

KOD CODE	İÇERİK CONTENTS	g	TL/Ad.	
1113 00 6009	Torx® Uçlar 60mm Star Socket T20 - T25 - T27 - T30 - T40 - T45 T50 - T55 - T60	1125	9	311,40

Havalı aletler ile kullanmayınız / Do not use with power-tools

1113

1/2" Lokmalı Allen Uç ve Star (Torx)® Uç Takımı (17 Parça)
Hex Bit Sockets - Torx Bit Sockets Set (17 Pcs)



1/2"

KOD CODE	İÇERİK CONTENTS	g	TL/Ad.
1113 00 6017	<p>T Koli (1/2") Sliding T Handle</p> <p>5 - 6 - 7 - 8 - 10 - 12 - 14</p> <p>Lokmalı Allen Uç 60mm Hex Bit Socket</p> <p>T20 - T25 - T27 T30 - T40</p> <p>Lokmalı Star (Torx) Uç 60mm Torx Bit Socket</p>	17	613,30

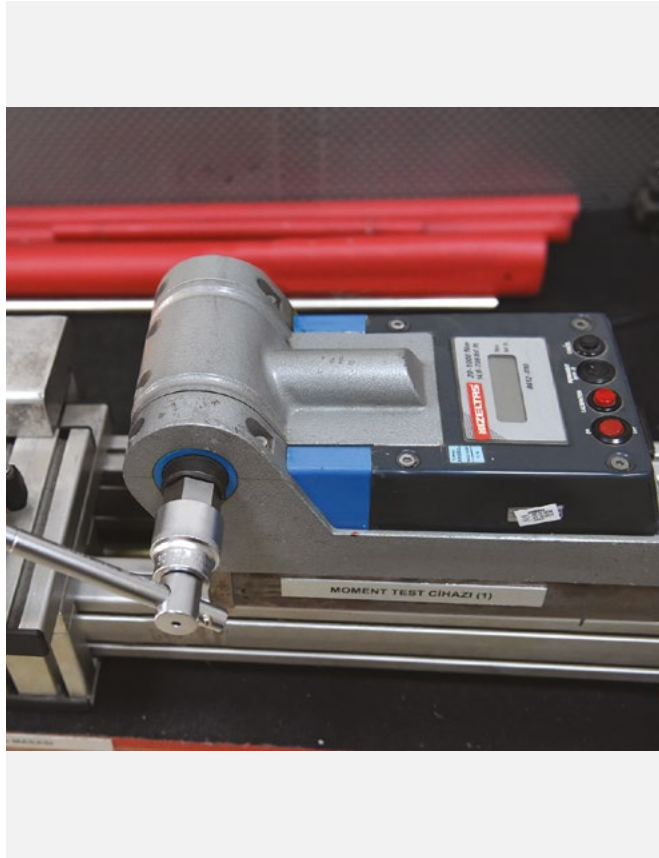

Havali aletler ile kullanmayınız / Do not use with power-tools

1114

1/2" On İki Köşe Lokmalı Bits Uç Yivli (XZN)
Hex Bit Socket 12 Points (XZN)



1/2"

Krom vanadyum, Krom kaplı
Chrom vanadium, Chrom plated

KOD CODE	Star	L mm	g	TL/Ad.
1114 06 4005	M5	60	60	25,45
1114 06 4006	M6	60	62	25,45
1114 06 4008	M8	60	62	25,45
1114 06 4010	M10	60	78	25,45
1114 06 4012	M12	60	84	30,15
1114 06 4106	M6	80	69	32,10
1114 06 4108	M8	80	70	32,10
1114 06 4110	M10	80	84	35,35
1114 06 4112	M12	80	103	36,55
1114 06 4114	M14	80	133	39,15
1114 06 4208	M8	140	96	36,00
1114 06 4210	M10	140	125	44,15
1114 06 4212	M12	140	161	49,75
1114 06 4214	M14	140	210	55,85
1114 06 4216	M16	140	281	81,00

1114

1/2" Lokmalı (Ribe) Bits Uç
Socket Wrench 6 Points



1/2"

Krom vanadyum, Krom kaplı
Chrom vanadium, Chrom plated

KOD CODE	Star	L mm	g	TL/Ad.
1114 06 5004	4	100	75	35,00
1114 06 5005	5	100	76	35,00
1114 06 5006	6	100	76	35,00
1114 06 5007	7	100	77	35,00
1114 06 5008	8	100	78	35,00
1114 06 5009	9	100	85	35,30
1114 06 5010	10	100	96	35,30
1114 06 5011	10.5	100	96	36,10
1114 06 5012	12	100	121	44,95
1114 06 5013	13	100	148	49,35
1114 06 5014	14	100	150	49,35
1114 06 5016	16	100	198	66,75

(★) İşaretili olan ürünler stoklarla sınırlıdır.
Limited with stocks.

1513

1/2" Cırcır Kolu (32 Diş)
Ratchet Handle

TS ISO 3315
DIN3122



Krom vanadyum, Krom kaplı
Chrom vanadium, Chrom plated

1/2"

KOD CODE	L mm	g		TL/Ad.
1513 06 0032	250	580	5	161,00

1513

1/2" T Kol
Sliding T - Handle

TS ISO 3315
DIN 3122



Krom vanadyum, Krom kaplı
Chrom vanadium, Chrom plated

1/2"

KOD CODE	L mm	g		TL/Ad.
1513 06 2250	250	355	5	93,70

1513

1/2" Cırcır Kolu (72 Diş)
Max Gear Ratchet Handle

TS ISO 3315



Krom vanadyum, Krom kaplı
Chrom vanadium, Chrom plated

1/2"

KOD CODE	L mm	g		TL/Ad.
★1513 06 0072	250	460	5	285,15

1513

1/2" Mafsal
Universal Joint

TS ISO 3316
DIN 3123



Krom vanadyum, Krom kaplı
Chrom vanadium, Chrom plated

1/2"

KOD CODE	L mm	g		TL/Ad.
1513 06 4070	70	140	5	63,50

1513

1/2" Ara Kol
Extension Bar

TS ISO 3316
DIN 3123



Krom vanadyum, Krom kaplı
Chrom vanadium, Chrom plated

1/2"

KOD CODE	L mm	g		TL/Ad.
1513 06 4075	75	140	5	38,30
1513 06 4125	125	215	5	42,85
1513 06 4250	250	420	5	65,25

1513

1/2" Lokma Adaptörü
Adapter

TS ISO 3316
DIN 3123



Krom vanadyum, Krom kaplı
Chrom vanadium, Chrom plated

1/2"

KOD CODE	inch	g		TL/Ad.
1513 06 0002	1/2"Fx3/8"M	55	5	21,50
1513 06 0003	1/2"Fx3/4"M	115	5	33,80

1513

1/2" T Kol Adaptörü
Adapter



Krom vanadyum, Krom kaplı
Chrom vanadium, Chrom plated

1/2"

KOD CODE	inch	g		TL/Ad.
1513 06 5250	3/8"Fx1/2"M	90	5	40,00

1113

1/2" Bits Tutucu Lokma
Bit Holder Scket



Krom vanadyum
Chrom vanadium

1/2"

KOD CODE	Inch	g		TL/Ad.
1113 06 5010	1/2"F - 1/4" F	50	5	22,85

Havali aletler ile kullanmayınız / Do not use with power-tools

(★) İşaretli olan ürünler stoklarla sınırlıdır.
Limited with stocks.

1/4" - 1/2" Altı Köşe Lokma Anahtar Takımı (35 Parça)
Socket Wrench Set 6 Point 1/4" - 1/2" (35 Pcs)

**YENİ
NEW**

KOD CODE	LOKMALAR Sockets	AVADANLIKLAR Accessories	g		TL/Ad.
1113 00 1038	4 - 5 - 6 7 - 8 - 9 - 10 11 - 12 - 13 Altı Köşe Six Points	1/4" Cırcır kolu Ratchet Handle 1/4" Mafsal Universal Joint 1/4" T Kol Sliding T Handle 1/4" Ara Kol Extension Bar 50 mm 1/4" Ara Kol Extension Bar 100 mm	4000	35	926,05
	10 - 11 - 12 13 - 14 - 15 16 - 17 - 18 19 - 21 - 22 24 - 27 - 30 32 Altı Köşe Six Points	1/2" Cırcır Kolu Ratchet Handle 1/2" T Kol Adaptör Sliding T Handle Adapter 1/2" Ara Kol Extension Bar 75 mm 1/2" Ara Kol Extension Bar 250 mm			

1113
1/2" Altı Köşe Lokma Anahtar Takımı (17 Parça, mm)
Socket Wrench Set 6 Points (17 pcs, mm)

1/2"

KOD CODE	LOKMALAR Sockets	AVADANLIKLAR Accessories	g	□	TL/Ad.
1113 00 2017		1/2" Cırcır Kolu Ratchet Handle	2880	17	646,20
		1/2" T Kol Adaptör Sliding T Handle Adapter			
	10 - 11 - 12 13 - 14 - 15 17 - 19 - 22 24 - 27 - 30 32	1/2" Mafsal Universal Joint			
		1/2" Ara Kol Extension Bar 250 mm			

1113
1/2" Altı Köşe Lokma Anahtar Takımı (24 Parça, mm)
Socket Wrench Set 6 Points (24 pcs, mm)

1/2"

KOD CODE	LOKMALAR Sockets	AVADANLIKLAR Accessories	g	□	TL/Ad.
1113 00 2024		1/2" Cırcır Kolu Ratchet Handle	3650	24	839,20
		1/2" Mafsal Universal Joint			
	10 - 11 - 12 13 - 14 - 15 16 - 17 - 18 19 - 21 - 22 23 - 24 - 26 27 - 28 - 30 32	1/2" T Kol Adaptör Sliding T Handle Adapter			
		1/2" Ara Kol Extension Bar 125 mm			
		1/2" Ara Kol Extension Bar 250 mm			

1114
1/2" On İki Köşe Lokma Anahtar Takımı (24 Parça, mm)
Socket Wrench Set 12 Points (24 pcs, mm)

1/2"

KOD CODE	LOKMALAR Sockets	AVADANLIKLAR Accessories	g	□	TL/Ad.
1114 00 6024		1/2" Cırcır Kolu Ratchet Handle	4150	24	903,55
		1/2" Mafsal Universal Joint			
	10 - 11 - 12 13 - 14 - 15 16 - 17 - 18 19 - 21 - 22 23 - 24 - 26 27 - 28 - 30 32	1/2" T Kol Adaptör Sliding T Handle Adapter			
		1/2" Ara Kol Extension Bar 125 mm			
		1/2" Ara Kol Extension Bar 250 mm			

1413
1/2" On İki Köşe Lokma Anahtar Takımı (24 parça, SAE)
Socket Wrench Set 12 Points (24 pcs, SAE)

1/2"

KOD CODE	LOKMALAR Sockets	AVADANLIKLAR Accessories	g	□	TL/Ad.
1413 00 6024		1/2" Cırcır Kolu Ratchet Handle	4150	24	1012,30
		1/2" Mafsal Universal Joint			
	5/16" - 3/8" 7/16" - 15/32" 1/2" - 9/16" 19/32" - 5/8" 11/16" - 3/4" 25/32" - 13/16" 7/8" - 15/16" 1" - 1 1/16" 1 1/8" - 1 3/16" 1 1/4"	1/2" T Kol Adaptör Sliding T Handle Adapter			
		1/2" Ara Kol Extension Bar 125 mm			
		1/2" Ara Kol Extension Bar 250 mm			

1113

1/2" Manyetik Lokma (mm)
Socket Wrench 6 Points (mm)

TS ISO 2725 -1
DIN 3124

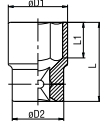
1/2"

Krom vanadyum, Krom kaplı
Chrom vanadium, Chrom plated

KOD CODE	mm	Ø D1 mm	Ø D2 mm	L mm	g	TL/ Ad.
★1113 06 3008	8	13.2	21.8	38	55	10 18,90
★1113 06 3010	10	15	23.3	38	55	10 27,45
★1113 06 3012	12	17.8	23.3	38	60	10 27,45
★1113 06 3014	14	20.4	23.3	38	65	10 33,50

1113

1/2" Manyetik Lokma Torx® Uç
Magnetic Socket Wrench 6 Points - Torx® Bits

1/2"

Krom vanadyum, Krom kaplı
Chrom vanadium, Chrom plated

KOD CODE	Torx® Uçlar Torx® Bits	Kullanılan Lokma For Dimensions	g	TL/Ad.
★1113 06 3120	T20	8mm Manyetik Lokma Magnetic Socket Wrench	9	10 11,65
★1113 06 3125	T25		9	10 11,65
★1113 06 3127	T27		9	10 11,65
★1113 06 3130	T30		9.4	10 11,65
★1113 06 3140	T40		10.2	10 11,65
★1113 06 3145	T45		11	10 14,20
★1113 06 3150	T50	11.7	10 15,05	
★1113 06 3155	T55	10mm Manyetik Lokma Magnetic Socket Wrench	18.2	10 16,25
★1113 06 3160	T60	14mm Manyetik Lokma Magnetic Socket Wrench	31.6	10 17,55

1113

1/2" Manyetik Lokma Allen Uç (mm)
Magnetic Socket Wrench 6 Points (mm) - Hex Bits

1/2"

Krom vanadyum, Krom kaplı
Chrom vanadium, Chrom plated

KOD CODE	ALLEN UÇLAR HEX BITS	Kullanılan Lokma For Dimensions	g	TL/ Ad.
★1113 06 3205	5mm	8mm Manyetik Lokma Magnetic Socket Wrench	12	10 10,20
★1113 06 3206	6mm		139	10 10,20
★1113 06 3207	7mm		14	10 10,20
★1113 06 3208	8mm		14	10 11,20
★1113 06 3210	10mm	10mm Manyetik Lokma Magnetic Socket Wrench	24	10 11,50
★1113 06 3212	12mm	12mm Manyetik Lokma Magnetic Socket Wrench	37	10 14,75
★1113 06 3214	14mm	14mm Manyetik Lokma Magnetic Socket Wrench	42	10 16,50

1113

1/2" Manyetik Lokmalı Uç Takımı (20 Parça)
Magnetic Hex Bit Sockets Torx® Bit Sockets Set (20 Pcs)

1/2"

KOD CODE	İÇERİK CONTENTS	TL/Ad.
★1113 00 3020	Manyetik Lokma (1/2") Magnetic Socket Wrench 8 -10 -12 -14 Allen Uç Hex Bit Socket 5-6-7-8-10-12-14 Torx® Uç / Torx® Bits T20 - T25 - T27 -T30 - T40 T45 - T50 - T55 - T60	313,15
	20	

1119
3/4" Altı Köşe Lokma Anahtar (mm)
Socket Wrench 6 Points (mm)

 TS ISO 2725 -1
 DIN 3124

3/4"

 Krom vanadyum, Krom kaplı
Chrom vanadium, Chrom plated

KOD CODE	mm	Ø D1 mm	Ø D2 mm	L mm	L1 mm	g	TL/Ad.
1119 06 1022	22	33	36	52	16	225	5 53,30
1119 06 1024	24	35	36	52	16	230	5 53,30
1119 06 1027	27	38	36	52	19	235	5 55,05
1119 06 1030	30	42	38	54	21	300	5 59,35
1119 06 1032	32	44	38	56	23	320	5 61,75
1119 06 1034	34	47	42	58	24	400	5 81,45
1119 06 1036	36	50	42	58	25	440	5 81,45
1119 06 1038	38	52	45	60	27	500	5 81,45
1119 06 1041	41	56	45	64	29	580	1 119,75
1119 06 1046	46	62	48	68	33	730	1 127,50
1119 06 1050	50	68	48	72	34	885	1 153,10
1119 06 1055	55	74	48	76	37	1070	1 194,95
1119 06 1060	60	80	48	78	38	1170	1 232,80

1419
3/4" On İki Köşe Lokma Anahtar (SAE)
Socket Wrench 12 Points (SAE)

3/4"

 Krom vanadyum, Krom kaplı
Chrom vanadium, Chrom plated

KOD CODE	inch	Ø D1 mm	Ø D2 mm	L mm	L1 mm	g	TL/Ad.
1419 06 1022	7/8"	33	36	52	16	220	5 63,65
1419 06 1024	15/16"	35	36	52	16	220	5 63,65
1419 06 1025	1"	35	36	52	17	220	5 63,90
1419 06 1027	1 1/16"	38	36	52	19	225	5 65,55
1419 06 1028	1 1/8"	40	38	52	19	225	5 65,55
1419 06 1032	1 1/4"	44	38	56	23	315	5 73,60
1419 06 1033	1 5/16"	46	38	56	23	355	5 91,60
1419 06 1035	1 3/8"	48	42	58	25	400	5 91,60
1419 06 1036	1 7/16"	50	42	58	25	425	5 95,95
1419 06 1038	1 1/2"	52	45	60	27	475	5 95,95
1419 06 1041	1 5/8"	56	45	64	29	555	1 142,20
1419 06 1044	1 3/4"	60	47	66	31	660	1 150,10
1419 06 1046	1 13/16"	62	47	68	34	685	1 151,05
1419 06 1047	1 7/8"	64	48	70	34	730	1 181,20
1419 06 1050	2"	68	48	72	34	805	1 182,50

1120
3/4" On İki Köşe Lokma Anahtar (mm)
Socket Wrench 12 Points (mm)

 TS ISO 2725 - 1
 DIN 3124

3/4"

 Krom vanadyum, Krom kaplı
Chrom vanadium, Chrom plated

KOD CODE	mm	Ø D1 mm	Ø D2 mm	L mm	L1 mm	g	TL/Ad.
1120 06 1022	22	33	36	52	16	220	5 56,35
1120 06 1024	24	35	36	52	17	225	5 56,35
1120 06 1027	27	38	36	52	19	225	5 58,10
1120 06 1030	30	42	38	54	21	285	5 62,60
1120 06 1032	32	44	38	56	23	310	5 65,50
1120 06 1034	34	47	42	57	24	385	5 86,15
1120 06 1036	36	50	42	58	25	435	5 86,15
1120 06 1041	41	56	45	64	29	560	1 127,15
1120 06 1046	46	62	47	68	34	685	1 135,20
1120 06 1050	50	68	48	72	34	840	1 161,85

1519
3/4" Cırcır Kolu
Ratchet Handle

 TS ISO 3315
 DIN 3122

3/4"

 Krom vanadyum, Krom kaplı
Chrom vanadium, Chrom plated

KOD CODE	L mm	g	TL/Ad.
1519 06 4510	510	2230	5 541,50

1519
3/4" Ara Kol
Extension Bar

 TS ISO 3316
 DIN 3123

3/4"

 Krom vanadyum, Krom kaplı
Chrom vanadium, Chrom plated

KOD CODE	L mm	g	TL/Ad.
1519 06 4200	200	730	5 132,55
1519 06 4400	400	1370	5 240,10

Havalı aletler ile kullanmayınız / Do not use with power-tools

1519

3/4" T Kol
Sliding T - Handle

TS ISO 3315
DIN 3122



3/4"

Krom vanadyum, Krom kaplı
Chrom vanadium, Chrom plated

KOD CODE	L mm	g		TL/Ad.
1519 06 4500	500	1485	5	267,20

1519

3/4" Lokma Adaptörü
Adapter

TS ISO 3316
DIN 3123



3/4"

Krom vanadyum, Krom kaplı
Chrom vanadium, Chrom plated

KOD CODE	inch	g		TL/Ad.
1519 06 0008	3/4"Fx1/2"M	140	5	56,85
1519 06 0001	3/4"Fx1"M	300	5	76,90

1119

3/4" Altı Köşe Lokma Anahtar Takımı (14 parça, mm)
Socket Wrench Set 6 Points (14 pcs, mm)



3/4"

KOD CODE	LOKMALAR Sockets	AVADANLIKLAR Accessories	g		TL/Ad.
1119 00 6114	22 - 24 - 27 30 - 32 - 34 36 - 41 - 46 50	3/4" Cırcır Kolu Ratchet Handle	10180	14	2027,35
		3/4" T Kol Sliding T Handle			
		3/4" Ara Kol Extension Bar 200 mm			
		3/4" Ara Kol Extension Bar 400 mm			

1120

3/4" On İki Köşe Lokma Anahtar Takımı (14 parça, mm)
Socket Wrench Set 12 Points (14 pcs, mm)



3/4"

KOD CODE	LOKMALAR Sockets	AVADANLIKLAR Accessories	g		TL/Ad.
1120 00 6014	22 - 24 - 27 30 - 32 - 34 36 - 41 - 46 50	3/4" Cırcır Kolu Ratchet Handle	13700	14	2076,75
		3/4" T Kol Sliding T Handle			
		3/4" Ara Kol Extension Bar 200 mm			
		3/4" Ara Kol Extension Bar 400 mm			

1419

3/4" On İki Köşe Lokma Anahtar Takımı (14 parça, SAE)
Socket Wrench Set 12 Points (14 pcs, SAE)



3/4"

KOD CODE	LOKMALAR Sockets	AVADANLIKLAR Accessories	g		TL/Ad.
1419 00 6114	15/16" - 1 1/16" 1 1/8" - 1 1/4" 1 5/16" 1 3/8" 1 1/2" - 1 5/8" 1 7/8" - 2"	3/4" Cırcır Kolu Ratchet Handle	10180	14	2234,75
		3/4" T Kol Sliding T Handle			
		3/4" Ara Kol Extension Bar 200 mm			
		3/4" Ara Kol Extension Bar 400 mm			

1225

1" On İki Köşe Lokma Anahtar (mm)
Socket Wrench 12 Points (mm)

TS ISO 2727-1
DIN 3124

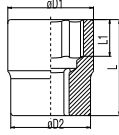

1"

Krom vanadyum, Krom kaplı
Chrom vanadium, Chrom plated

KOD CODE	Ø mm	Ø D1 mm	Ø D2 mm	L mm	L1 mm	g	TL/Ad.
1225 06 0036	36	52	48	65	26	525	1 166,95
1225 06 0041	41	58	50	70	29	665	1 181,75
1225 06 0046	46	65	54	75	32	900	1 220,35
1225 06 0050	50	70	57	75	34	1040	1 261,00
1225 06 0055	55	76	57	83	42	1250	1 335,40
1225 06 0060	60	82	60	87	46	1505	1 434,45

1525

1" Lokma Adaptörü
Adapter

TS ISO 3316
DIN 3123



1"

Krom vanadyum, Krom kaplı
Chrom vanadium, Chrom plated

KOD CODE	inch	g	TL/Ad.
1525 06 0005	1"Fx3/4"M	330	5 109,70

1113

1/2" Alaşımli Jant Lokma Takımı (3 Parca, mm)
Combination Lug Nut Socket Set (3 Pcs, mm)



1/2"

KOD CODE	LOKMA LAR Sockets	g	TL/Ad.
1113 00 9003	17-19-21	800	3 342,60

1113

1/2" Alaşımli Jant Lokma Takımı (7 Parca, mm)
Combination Lug Nut Socket Set (7 Pcs, mm)



1/2"

KOD CODE	LOKMA LAR Sockets	g	TL/Ad.
★1113 00 9007	17 - 19 - 21 - 22 23 - 24 - 27	2250	7 562,15

(★) İşaretili olan ürünler stoklarla sınırlıdır.
Limited with stocks.

1113

1/2" Altı Köşe Havalı Lokma Anahtar (mm)
Impact Socket Wrench 6 Points (mm)

TS ISO 2725-2



İZELTAŞ YOUTUBE



1/2"

Krom molibden, Fosfat kaplamalı
Chrom molybdenum, Phosphate finish



KOD CODE	mm	Ø D1 mm	Ø D2 mm	L mm	L1 mm	g	TL/Ad.	
1113 06 7010	10	17	25	38	8	70	10	24,95
1113 06 7011	11	18	25	38	8	70	10	24,95
1113 06 7012	12	19	25	38	9	70	10	24,95
1113 06 7013	13	20	25	38	10	70	10	26,70
1113 06 7014	14	22	25	38	10	75	10	26,70
1113 06 7015	15	23	30	38	11	110	10	26,70
1113 06 7016	16	24	30	38	11	110	10	27,95
1113 06 7017	17	26	30	38	12	115	10	28,00
1113 06 7018	18	27	30	38	13	115	10	28,05
1113 06 7019	19	28	30	38	13	120	10	28,65
1113 06 7021	21	30	30	40	14	125	5	29,15
1113 06 7022	22	32	30	40	14	145	5	29,15
1113 06 7024	24	34	30	42	15	150	5	33,45
1113 06 7027	27	38	30	44	16	175	5	48,65

1513

1/2" Havalı Lokma Ara Kol
Impact Socket Extension Bar



1/2"

Krom molibden, Fosfat kaplamalı
Chrom molybdenum, Phosphate finish

KOD CODE	L mm	g	TL/Ad.	
1513 06 7125	125	275	5	95,10
★ 1513 06 7250	250	450	5	128,45

1108

1/2" Altı Köşe Havalı Derin Lokma Anahtar (mm)
6 Point Impact Socket Wrench, Long Type (mm)



1/2"



Krom molibden, Fosfat kaplamalı
Chrom molybdenum, Phosphate finish

KOD CODE	mm	L mm	g	TL/Ad.	
1108 06 7010	10	80	136	10	44,20
1108 06 7011	11	80	144	10	44,20
1108 06 7012	12	80	157	10	44,20
1108 06 7013	13	80	157	10	48,00
1108 06 7014	14	80	172	10	48,00
1108 06 7015	15	80	223	10	53,60
1108 06 7016	16	80	230	10	53,60
1108 06 7017	17	80	240	10	53,60
1108 06 7018	18	80	255	10	53,60
1108 06 7019	19	80	236	10	53,60
1108 06 7021	21	80	240	10	55,90
1108 06 7022	22	80	296	5	55,90
1108 06 7024	24	80	308	5	59,10
1108 06 7027	27	80	356	5	78,20
1108 06 7030	30	80	416	5	87,60
1108 06 7032	32	80	510	5	93,40

1513

1/2" Havalı Lokma Adaptörü
Impact Socket Adapter



1/2"

Krom molibden, Fosfat kaplamalı
Chrom molybdenum, Phosphate finish

KOD CODE	inch	g	TL/Ad.	
1513 06 7002	1/2"Fx3/8"M	95	5	62,90
1513 06 7003	1/2"Fx3/4"M	175	5	71,80

1513

1/2" Havalı Lokma Mafsal
Impact Socket Universal Joint



1/2"

Krom molibden, Fosfat kaplamalı
Chrom molybdenum, Phosphate finish

KOD CODE	L mm	g	TL/Ad.	
1513 06 7075	75	220	5	120,75

1119

3/4" Altı Köşe Havalı Lokma Anahtar (mm) Impact Socket Wrench 6 Points (mm)



3/4"

Krom molibden, Fosfat kaplamalı
Chrom molybdenum, Phosphate finish

KOD CODE	mm	Ø D1 mm	Ø D2 mm	L mm	L1 mm	g	TL/Ad.
1119 06 7019	19	32	44	50	13	330	5 78,20
1119 06 7021	21	35	44	50	15	340	5 78,20
1119 06 7022	22	36	44	50	15	345	5 78,20
1119 06 7024	24	38	44	50	16	350	5 78,20
1119 06 7027	27	42	44	53	17	380	5 80,40
1119 06 7030	30	46	44	53	20	410	1 86,65
1119 06 7032	32	48	44	57	20	460	1 86,65
1119 06 7034	34	51	44	57	22	490	1 113,00
1119 06 7036	36	53	44	57	22	520	1 113,00
1119 06 7041	41	59	44	58	24	580	1 174,35
1119 06 7046	46	66	44	62	24	715	1 185,35

1519

3/4" Havalı Lokma Ara Kol Impact Socket Extension Bar



3/4"

Krom molibden, Fosfat kaplamalı
Chrom molybdenum, Phosphate finish

KOD CODE	L mm	g	TL/Ad.
1519 06 7175	175	865	5 207,50
1519 06 7250	250	1155	5 296,75
1519 06 7330	330	1425	5 450,35

1519

3/4" Havalı Lokma Mafsal Impact Socket Universal Joint



3/4"

Krom molibden, Fosfat kaplamalı
Chrom molybdenum, Phosphate finish

KOD CODE	L mm	g	TL/Ad.
1519 06 7108	108	735	5 345,65

1519

3/4" Havalı Lokma Adaptörü Impact Socket Adapter



3/4"

Krom molibden, Fosfat kaplamalı
Chrom molybdenum, Phosphate finish

KOD CODE	inch	g	TL/Ad.
1519 06 7011	3/4"Fx1/2"M	315	5 119,75

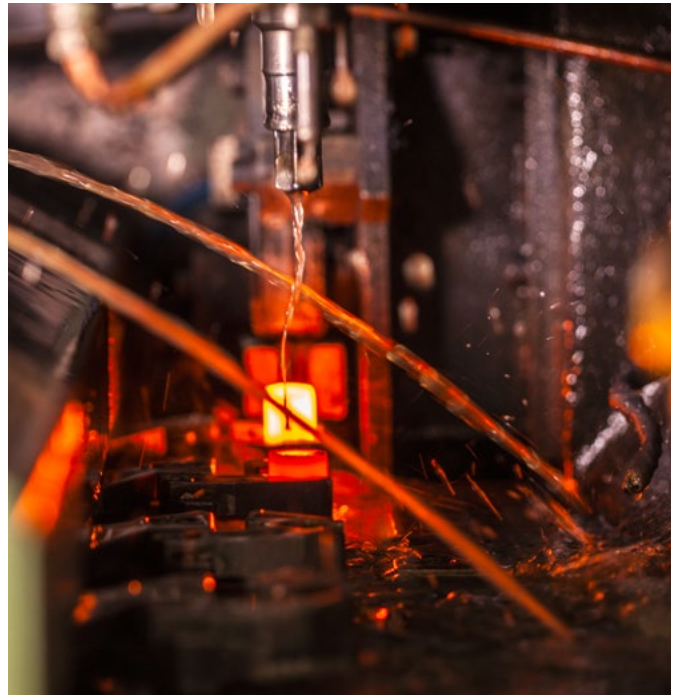

1125

1" Altı Köşe Havalı Lokma Anahtar (mm) Impact Socket Wrench 6 Points (mm)



1"

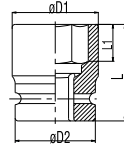

Krom molibden, Fosfat kaplamalı
Chrom molybdenum, Phosphate finish

KOD CODE	mm	σ D1 mm	σ D2 mm	L mm	L1 mm	g	TL/Ad.
1125 06 7024	24	41	54	58	17	560	1 140,80
1125 06 7027	27	44	54	58	19	565	1 142,05
1125 06 7030	30	48	54	60	21	605	1 143,25
1125 06 7032	32	51	54	62	21	650	1 144,95
1125 06 7033	33	52	54	62	21	660	1 144,95
1125 06 7034	34	53	54	62	24	765	1 145,70
1125 06 7036	36	56	54	65	24	720	1 146,40
1125 06 7038	38	58	54	65	26	735	1 152,40
1125 06 7041	41	61	54	70	28	845	1 185,75
1125 06 7046	46	68	54	75	30	1075	1 204,95
1125 06 7050	50	73	54	75	32	1170	1 218,60
1125 06 7055	55	79	54	83	37	1435	1 289,85
1125 06 7060	60	86	54	87	37	1760	1 362,25

1525

1" Havalı Lokma Ara Kol Impact Socket Extension Bar



1"

Krom molibden, Fosfat kaplamalı
Chrom molybdenum, Phosphate finish

KOD CODE	L mm	g	TL/Ad.
1525 06 7175	175	1395	5 377,65
1525 06 7250	250	1890	5 485,70
1525 06 7330	330	2455	5 589,60

1525

1" Havalı Lokma Mafsal Impact Socket Universal Joint



1"

Krom molibden, Fosfat kaplamalı
Chrom molybdenum, Phosphate finish

KOD CODE	L mm	g	TL/Ad.
1525 06 7128	128	1530	1 705,85

1525

1" Havalı Lokma Adaptörü Impact Socket Adapter



1"

Krom molibden, Fosfat kaplamalı
Chrom molybdenum, Phosphate finish

KOD CODE	inch	g	TL/Ad.
1525 06 7015	1"Fx3/4"M	560	5 144,80



1800

Kovan Anahtar İki Ağız (mm) Double Ended Tubular Socket Wrench (mm)

TS ISO 3793
DIN 896

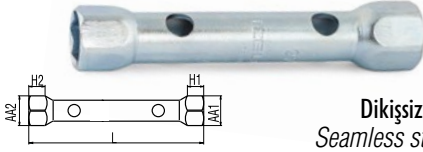

Dikişsiz çelik boru, Çinko kaplı
Seamless steel tube, Zinc plated

KOD CODE	mm	L mm	AA1 mm	AA2 mm	H1 mm	H2 mm	g	TL/Ad.	
1800 07 0607	6x7	105	8.6	9.6	7	8	25	5	24,30
1800 07 0809	8x9	105	11.2	12.2	9	10	35	5	26,70
1800 07 1011	10x11	120	13.6	14.6	11	11.5	55	5	36,65
1800 07 1213	12x13	135	16	17	12	12.5	80	5	38,85
1800 07 1415	14x15	135	18.5	19.5	13	13.5	110	5	42,60
1800 07 1617	16x17	150	21	22	14	14.5	150	5	45,75
1800 07 1819	18x19	150	23	24	15	15.5	170	5	47,40
1800 07 2022	20x22	165	25.4	27.4	16	18	220	5	52,25
★1800 07 2123	21x23	165	26.4	28.4	17	19	240	5	56,30
1800 07 2224	22x24	180	27.4	29.4	18	20	330	5	58,65
★1800 07 2426	24x26	180	30.4	32.4	20	22	340	5	73,05
1800 07 2427	24x27	180	30.4	33.4	20	23	400	5	75,85
★1800 07 2528	25x28	200	31.4	34.4	21	24	400	5	85,95
★1800 07 2732	27x32	200	33.4	38.4	23	26	435	5	100,00

1800

Kovan Anahtar Takımı İki Ağız (mil dahil, mm) Double Ended Tubular Socket Wrench Set with Tommy Bars (mm)



KOD CODE	mm	g	TL/Ad.	
1800 00 2108	6x7 - 8x9 - 10x11 - 12x13 - 14x15 16x17 - 18x19 - 20x22 Mil/Handle Bars 5x125-8x180 mm	920	10	338,75

1841

Kovan Anahtar Bir Ağız (mil dahil) Single Ended Tubular Socket Wrench with Tommy Bar



Dikişsiz çelik boru, Çinko kaplı
Seamless steel tube, Zinc plated

KOD CODE	mm		L mm	ØD mm	Mil Handle bar mm	g	TL/Ad.	
	mm	inch						
1841 07 0021	21	13/16"	120	20	10x120	215	5	39,10

1850

Kovan Anahtar Mili Tommy Bar

TS ISO 3793
DIN 900



KOD CODE	ØDxL mm	g	TL/Ad.	
1850 07 5125	5x125	20	10	9,60
1850 07 8180	8x180	70	10	14,65
1850 07 1120	10x120	75	10	16,65
1850 07 1200	10x200	120	10	18,75

1870

Ağır Tip Bijon Anahtarı İki Ağız Uzun Double Ended Rim Wrench (long)

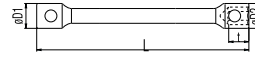

Yüksek alaşımlı çelik, Nikel kaplı
Special steel, Nickel plated

KOD CODE	mm	L mm	t mm	ØD1 mm	ØD2 mm	g	TL/Ad.	
1870 09 2427	24x27	400	34.5	36	40	1135	10	103,10
1870 09 2730	27x30	400	34.5	40	44	1380	10	118,50
1870 09 2732	27x32	400	34.5	40	46	1380	10	118,50
1870 09 3032	30x32	400	34.5	44	46	1380	10	122,60
1870 09 3233	32x33	400	34.5	46	47	1450	10	136,05

1874

Ağır Tip Bijon Anahtarı İki Ağız Kısa Double Ended Rim Wrench (short)

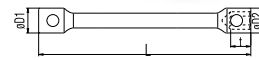

Yüksek alaşımlı çelik, Nikel kaplı
Special steel, Nickel plated

KOD CODE	mm	L mm	t mm	ØD1 mm	ØD2 mm	g	TL/Ad.	
1874 09 2224	22x24	170	34.5	34	36	720	10	65,30
1874 09 2427	24x27	200	34.5	36	40	800	10	83,50

1850

Bijon Anahtar Mili Tommy Bar

TS ISO 3793
DIN 900

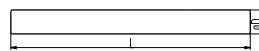

KOD CODE	ØDxL mm	g	TL/Ad.	
1850 09 1630	18x630	1260	1	60,00

1975

Bijon Anahtarı İstavroz Tipi Cross Rim Wrench

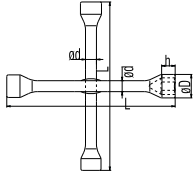

TS ISO 6788



Yüksek alaşımlı çelik, Krom kaplı
Special steel, Chrom plated

KOD CODE	mm	inch	σD mm	h mm	L mm	σd mm	g	TL/Ad.
	17	11/16"	28	17				
1975 09 1719	19	3/4"	30	18.5	420	16	1422	10 123,25
	21	13/16"	32	19.5				
	22	7/8"	34	20.5				

1975

1/2" Adaptörlü Bijon Anahtarı İstavroz Tipi Cross Rim Wrench (with 1/2" adapter)

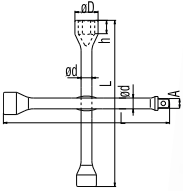

TS ISO 6788



Yüksek alaşımlı çelik, Krom kaplı
Special steel, Chrom plated

KOD CODE	mm	inch	σD mm	h mm	L mm	A mm	σd mm	g	TL/Ad.
	17	11/16"	28	17					
1975 09 1322	19	3/4"	30	18.5	420	12.65	16	1375	10 125,50
	22	7/8"	34	20.5					
		1/2"							

1940

Bijon Anahtarı Pipo Tipi (Tornavida Ağızlı) Offset Socket Wrench with Screwdriver

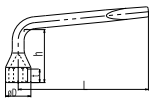
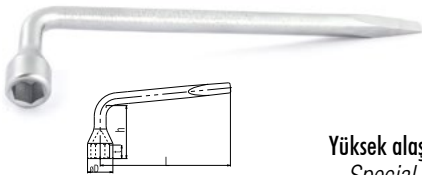

TSEK

Yüksek alaşımlı çelik, Krom kaplı
Special steel, Chrom plated

KOD CODE	mm	inch	L mm	σD mm	h mm	g	TL/Ad.
1940 09 0017	17	11/16"	285	28	65	485	10 51,60
1940 09 0019	19	3/4"	285	30	65	470	10 54,50
1940 09 0021	21	13/16"	320	32	85	575	10 67,35

1840

1/2" Mafsallı T Kol Swivel Handle With Sliding T 1/2"



Özel alaşım çelik, Krom kaplı
Special steel, Chrom plated

1/2"

KOD CODE	mm	L mm	g	TL/Ad.
1840 08 0500	1/2"	500	740	10 253,85

1855

Mafsallı T Kol Lokma T - Handle Wrench with Universal Joint



Özel alaşım çelik, Krom kaplı
Special steel, Chrom plated

KOD CODE	mm	L mm	g	TL/Ad.
1855 08 0008	8	400	225	10 254,90
1855 08 0010	10	450	405	10 320,55
1855 08 0012	12	450	410	10 320,55
1855 08 0013	13	450	425	10 320,55
1855 08 0017	17	500	485	10 357,05
1855 08 0019	19	510	895	10 453,85

1845

Mafsallı Buji Lokma Spark Plug Wrench with Universal Joint



Özel alaşım çelik, Krom kaplı
Special steel, Chrom plated

KOD CODE	mm	L mm	g	TL/Ad.
★1845 08 0160	16	500	525	10 310,55
★1845 08 0208	20.8	520	960	10 377,80

1857

T Kol Lokma T - Handle Hexagonal Socket Wrench

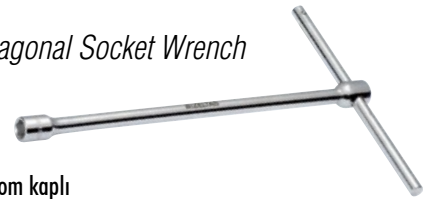

Özel alaşım çelik, Krom kaplı
Special steel, Chrom plated

KOD CODE	mm	L mm	g	TL/Ad.
★1857 08 0013	13	260	315	10 127,85
★1857 08 0017	17	280	470	10 163,55

1610

3/8" Tork Anahtarı Torque Wrench

TS EN ISO 6789-1
TS EN ISO 6789-2



3/8"

KOD CODE	ÖLÇÜ SIZE	L mm	g	TL/Ad.
1610 06 0100	2.5 - 11 Nm - 0.3 - 1.2 Kg	310	515	1 1405,55
1610 06 0300	7 - 33 Nm - 0.5 - 3.4 Kg	425	640	1 1453,10

1613

1/2" Tork Anahtarı Torque Wrench

TS EN ISO 6789-1
TS EN ISO 6789-2



1/2"

KOD CODE	ÖLÇÜ SIZE	L mm	g	TL/Ad.
1613 06 1200	25 - 135 Nm - 3 - 14 Kg	550	1430	1 1500,65
1613 06 2000	50 - 225 Nm - 5 - 23 Kg	600	2165	1 1548,95
1613 06 3000	70 - 330 Nm - 7 - 35 Kg	830	2870	1 1884,80

1619

3/4" Tork Anahtarı Torque Wrench

TS EN ISO 6789-1
TS EN ISO 6789-2



3/4"

KOD CODE	ÖLÇÜ SIZE	L mm	g	TL/Ad.
1619 06 2080	200 - 800 Nm-22-82 kg	1030	8860	1 5808,25

1607

1/4" Cırcırlı Tork Anahtar Torque Wrench With Reversible Ratchet-Head

TS EN ISO 6789-1
TS EN ISO 6789-2



IZELTAS YOUTUBE

1/4"

KOD CODE	ÖLÇÜ SIZE	L mm	g	TL/Ad.
1607 06 0420	4 - 20 Nm	320	640	1 1112,60

1610

3/8" Cırcırlı Tork Anahtar Torque Wrench With Reversible Ratchet-Head

TS EN ISO 6789-1
TS EN ISO 6789-2



3/8"

KOD CODE	ÖLÇÜ SIZE	L mm	g	TL/Ad.
1610 06 2010	20 - 100 Nm	435	1300	1 1256,15

1613

1/2" Cırcırlı Tork Anahtar Torque Wrench With Reversible Ratchet-Head

TS EN ISO 6789-1
TS EN ISO 6789-2



1/2"

KOD CODE	ÖLÇÜ SIZE	L mm	g	TL/Ad.
1613 06 4020	40- 200Nm	520	1590	1 1287,50
1613 06 6034	60- 340Nm	610	1810	1 1349,80

1619

3/4" Cırcırlı Tork Anahtar Torque Wrench With Reversible Ratchet-Head

TS EN ISO 6789-1
TS EN ISO 6789-2



3/4"

KOD CODE	ÖLÇÜ SIZE	L mm	g	TL/Ad.
1619 06 1060	100-600 Nm	1050	5600	1 4080,00

1/2" CIRCIR KOL / RATCHET HANDLE

Lokmayı salmayan bilya tasarımı
(kare adaptörlü bilyalı tasarım)
Square adaptor with ball design to
lock sockets

Değiştirilebilir iç mekanizma
Inter-changeable inner mechanism

Yüksek dayanım için
güçlü 32 diş
32 teeth for high
endurance

Çift yönlü kullanım
sağlayan mandal tasarımı
Bi-directional latch design

Yüksek mukavemetli
alaşımli sıcak dövme çeliği
High strength alloyed cold
work tool steel

Nikel üzerine krom
kaplama ile korozyon
direncinde üst seviye koruma
High corrosion resistance with
chrome over nickel plating

Dayanımı yüksek sert plastikten ve
konforlu tutuş sağlayan yumuşak
elastomer malzemeden imal edilmiş çift
komponentli ergonomik sap
Two component ergonomic handle with high
strength and soft grip plastic



IZELTAS®

BORU ANAHTARLARI VE PENSELER

PIPE WRENCHES AND PLIERS

Boru Anahtarları
Pipe Wrenches

Fort Penseler
Water Pump Pliers

Ayarlı Penseler
Grip Wrenches

Penseler
Pliers

Kargaburunlar
Nose Pliers

Kerpetenler
Carpenter Pincers

Elektronikçi Penseler
Electronic Pliers



İZELTAS YOUTUBE

PIPE WRENCHES
AND PLIERS

BORU
ANAHTARLARI
PENSELER

Güçlü kavrama sağlayan
tırnaklı tutma yüzeyleri
Toothed surface for strong grip

Isıl işlem sonrasında indüksiyonda
sertleştirme ile kullanım ömrü
artırılmış kesici ağızlar
Heat-treated and induction hardened
cutting edges for long lifetime

Nikel üzerine krom kaplama ile
korozyon direncinde
üst seviye koruma
High corrosion resistance
with chrome over nickel plating

Yüksek karbonlu
sıcak dövme
çeliği ile artırılmış
dayanım
High carbon forged
steel for improved
durability

Düşmelere ve darbeye dayanıklı,
selüloz asetat ergonomik sap
Impact resistant cellulose acetate
handle



2100

Stilson Boru Anahtarı Pipe Wrench, Stilson



TS 3796



 Yedek parça sayfa 200
Spare parts page 200

Krom vanadyum, Dişler indüksiyonda sertleştirilmiş, Elektrostatik boyanmış
Chrom vanadium, Teeth induction hardened, Electrostatically painted

KOD CODE	L mm	L inch	mm	ÖLÇÜ SIZE Inch	g	TL/Ad.
2100 10 0008	200	8"	27	3/4"	280	1 150,95
2100 10 0010	250	10"	34	1"	550	1 194,50
2100 10 0012	300	12"	42	1 1/4"	725	1 218,80
2100 10 0014	350	14"	50	1 1/2"	1030	1 250,70
2100 10 0018	450	18"	60	2"	1775	1 341,00
2100 10 0024	600	24"	76	2 1/2"	2775	1 549,40

2110

Ağır Tip Boru Anahtarı Pipe Wrench, Heavy Duty



 Yedek parça sayfa 200
Spare parts page 200

Krom vanadyum, Dişler indüksiyonda sertleştirilmiş, Elektrostatik boyanmış
Chrom vanadium, Teeth induction hardened, Electrostatically painted

KOD CODE	L mm	L inch	mm	ÖLÇÜ SIZE Inch	g	TL/Ad.
2110 10 0008	200	8"	34	1"	425	1 203,60
2110 10 0010	250	10"	42	1 1/4"	795	1 252,75
2110 10 0012	300	12"	50	1 1/2"	1245	1 289,50
2110 10 0014	350	14"	60	2"	1710	1 337,00
2110 10 0018	450	18"	75	2 1/2"	2685	1 470,15
2110 10 0024	600	24"	90	3"	4370	1 758,20
2110 10 0036	900	36"	140	5"	7600	1 1679,50
2110 10 0048	1200	48"	165	6"	15600	1 3439,80

2200

Maşalı Boru Anahtarı (45°) Pipe Wrench (45°)



Krom vanadyum, Dişler indüksiyonda sertleştirilmiş, Elektrostatik boyanmış
Chrom vanadium, Teeth induction hardened, Electrostatically painted

KOD CODE	L mm	mm	ÖLÇÜ SIZE Inch	g	TL/Ad.
★2200 10 0005	255	22	1/2"	385	1 194,95
★2200 10 0010	335	35	1"	720	1 231,50
★2200 10 0015	470	46	1 1/2"	1345	1 327,00
★2200 10 0020	630	65	2"	2470	1 520,85

2201

Maşalı Boru Anahtarı (85°) Pipe Wrench (85°)



TS 3796
DIN 5234

 Yedek parça sayfa 200
Spare parts page 200

Krom vanadyum, Dişler indüksiyonda sertleştirilmiş, Elektrostatik boyanmış
Chrom vanadium, Teeth induction hardened, Electrostatically painted

KOD CODE	L mm	mm	ÖLÇÜ SIZE Inch	g	TL/Ad.
2201 10 0010	325	40	1"	870	1 151,30
2201 10 0015	430	60	1 1/2"	1585	1 234,30
2201 10 0020	585	70	2"	2700	1 350,85
2201 10 0030	690	100	3"	4270	1 531,90
2201 10 0040	760	130	4"	5800	1 797,80

2202

İsveç Tip Maşalı Boru Anahtarı Pipe Wrench, Swedish Pattern

DIN 5234



Krom vanadyum, Dişler indüksiyonda sertleştirilmiş, Elektrostatik boyanmış
Chrom vanadium, Teeth induction hardened, Electrostatically painted

KOD CODE	L mm	mm	ÖLÇÜ SIZE Inch	g	TL/Ad.
★2202 10 0010	320	40	1"	845	1 235,45
★2202 10 0015	410	60	1 1/2"	1465	1 340,40
★2202 10 0020	535	70	2"	2345	1 524,95

Üniversal Fort Pense
Waterpump Pliers UniversalTS 60 TS ISO 8976
DIN ISO 8976

IZELTAS YOUTUBE

Krom vanadyum, Krom kaplı, PVC izoleli
Chrom vanadium, Chrom plated, PVC insulated

KOD CODE	L mm	L inch	mm	g	TL/Ad.
2400 11 0160	160	6 1/4"	30	125	5 100,80
2400 11 0240	240	9 1/2"	35	355	5 140,95
2400 11 0315	315	12 1/2"	40	530	5 230,90

1000V İzoleli Üniversal Fort Pense
Insulated Type Waterpump Pliers Universal 1000VTS 60
TS ISO 8976**Krom vanadyum, Krom kaplı, çift komponent saplı**
Chrom vanadium, Chrom plated, Two component handle

KOD CODE	L mm	L inch	mm	g	TL/Ad.
2400 11 6240	240	9 1/2"	35	370	5 163,55

Yaylı Fort Pense
Waterpump Pliers With Spring**Krom vanadyum, Karartma, PVC izoleli**
Chrom vanadium, Black finish, PVC insulated

KOD CODE	L mm	L inch	mm	g	TL/Ad.
2415 11 0240	240	9 1/2"	35	365	5 190,20

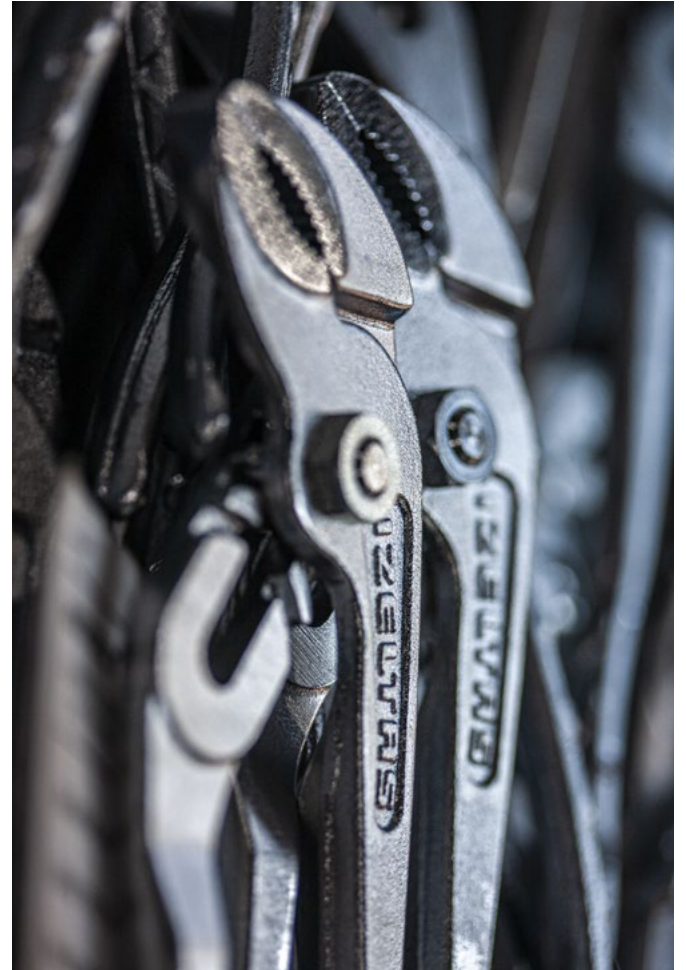



2500

Üniversal Ayarlı Pense Universal Grip



Çeneler krom vanadyum çeliğinden dövülmüştür, Nikel kaplama,
Kullanım sahası: Yuvarlak ve düz malzemeler
Jaws Chrom vanadium forged, Nickel plated
Application field : Flat and round materials

KOD CODE	L mm	L inch	 mm	 g		TL/Ad.
2500 11 0250	250	10"	30	560	5	165,35

2510

Spesiyal Ayarlı Pense Special Grip



Çeneler krom vanadyum çeliğinden dövülmüştür, Nikel kaplama,
Kullanım sahası: Yuvarlak ve düz malzemeler
Jaws Chrom vanadium forged, Nickel plated
Application field: Flat and round materials

KOD CODE	L mm	L inch	 mm	 g		TL/Ad.
2510 11 0250	250	10"	30	550	5	165,35

2505

Standart Ayarlı Pense Standard Grip

TSEK



Çeneler krom vanadyum çeliğinden dövülmüştür, Nikel kaplama
Kullanım sahası: Düz malzemeler
Jaws, Chrom vanadium forged, Nickel plated
Application field: Flat materials



KOD CODE	L mm	L inch	 mm	 g		TL/Ad.
2505 11 0250	250	10"	30	535	5	165,35

2511

C tipi Ayarlı Pense Clamp Grip C-type



Çeneler krom vanadyum çeliğinden dövülmüştür, Nikel kaplama,
Kullanım sahası: Açılı profillerin tutulmasında
Jaws Chrom vanadium forged, Nickel plated
Application field: For Gripping angled sheet metal

KOD CODE	L mm	L inch	 mm	 g		TL/Ad.
2511 11 0280	280	11"	70	700	1	241,90

Kaynakçı Ayarlı Pense (Düz Ağız)
Lock Grip With Flat Jaws

Özel alaşımli çelikten imal edilmiş, Nikel kaplama,
Kullanım sahası: 80 mm düz çeneleri ile kıvrık metal levhaları
*Made from special alloy steel, Nickel plated, Application field:
Gripping sheet metals with 80 mm Flat jaws*

KOD CODE	L mm	L inch	mm	g	TL/Ad.
2512 11 0200	200	8"	30	485	1 244,15

Kaportacı Ayarlı Pense
Welding Grip

Özel alaşımli çelikten imal edilmiş- Nikel kaplama,
Kullanım sahası: Yassı ve köşeli malzemelerde
*Made from special alloy steel, Nickel plated
Application field : Angled corners and edges*

KOD CODE	L mm	L inch	mm	g	TL/Ad.
2515 11 0270	270	10 5/8"	50	765	1 221,45

Kaynakçı Ayarlı Pense (Boru İçin)
Grip For Tubes

Özel alaşımli çelikten imal edilmiş, Nikel kaplama,
Kullanım sahası: Boru malzemeler
Made from special alloy steel, Nickel plated, Application field: Tubes

KOD CODE	L mm	L inch	mm	g	TL/Ad.
2513 11 0280	280	11"	50	800	1 244,15

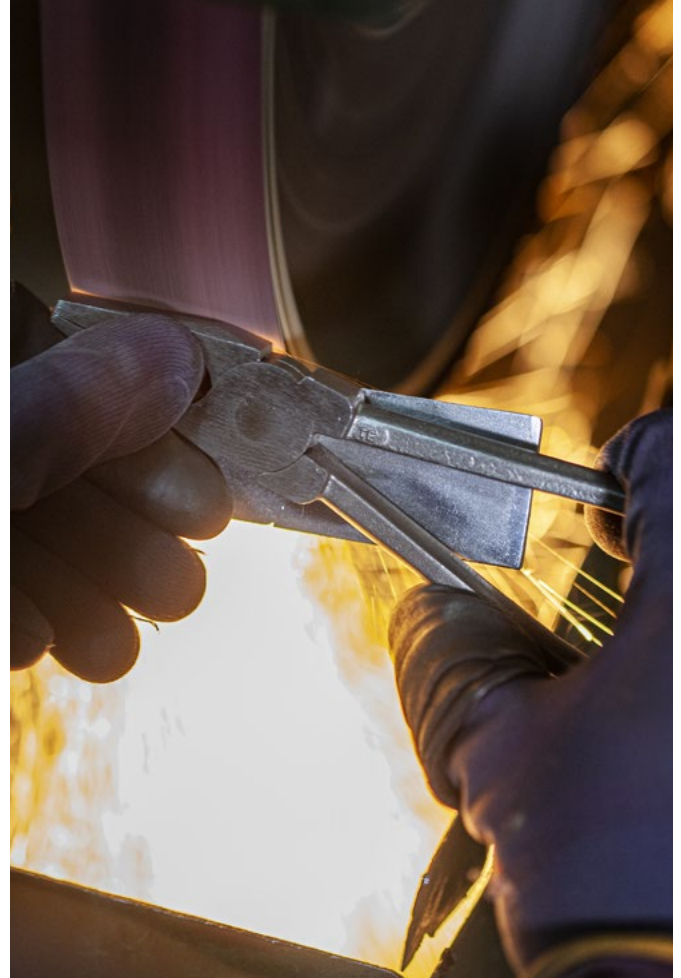

3020

Kombine Pense Opak Seri Combination Pliers

TS 60
TS ISO 5746
DIN ISO 5746



İZELTAS YOUTUBE

Özel alaşımli çelik, Kesici ağızlar indüksiyonda sertleştirilmiş
Special steel, Cutters induction hardened

KOD CODE	L mm	L inch	g	TL/Ad.
3020 12 2160	160	6 1/4"	205	87,60
3020 12 2180	180	7 1/8"	275	99,40
3020 12 2200	200	8"	315	112,25

3020

Kombine Pense Kraft Seri Combination Pliers

TS 60
TS ISO 5746
DIN ISO 5746



Özel alaşımli çelik, Kesici ağızlar indüksiyonda sertleştirilmiş
Special steel, Cutters induction hardened

KOD CODE	L mm	L inch	g	TL/Ad.
3020 12 3160	160	6 1/4"	225	107,35
3020 12 3180	180	7 1/8"	285	119,95
3020 12 3200	200	8"	380	135,50

3020

Kombine Pense Ergonomik Seri Combination Pliers

TS 60
TS ISO 5746
DIN ISO 5746



Özel alaşımli çelik, Kesici ağızlar indüksiyonda sertleştirilmiş
Special steel, Cutters induction hardened

KOD CODE	L mm	L inch	g	TL/Ad.
3020 12 5160	160	6 1/4"	205	110,20
3020 12 5180	180	7 1/8"	260	125,15
3020 12 5200	200	8"	345	141,30

3020

1000V İzoleli Elektrikçi Kombine Pense Electrician Type Insulated Combination Pliers 1000V



TS 60
TS ISO 5746
DIN ISO 5746



1000 V
IEC 60900



Özel alaşımli çelik, Kesici ağızlar indüksiyonda sertleştirilmiş, Krom kaplı
Special steel, Cutters induction hardened, Chrom plated

KOD CODE	L mm	L inch	g	TL/Ad.
3020 12 6160	160	6 1/4"	205	120,65
3020 12 6180	180	7 1/8"	260	129,15
3020 12 6200	200	8"	345	145,80

3030

Kombine Pense Ağır Tip (çelik tel için) Combination Pliers Heavy Duty (for piano wire)



Özel alaşımli çelik, Kesici ağızlar indüksiyonda sertleştirilmiş
Special steel, Cutters induction hardened

KOD CODE	L mm	L inch	g	TL/Ad.
3030 12 2180	180	7 1/8"	285	149,80
3030 12 2200	200	8"	380	171,30

(*) İşaretili olan ürünler stoklarla sınırlıdır.
Limited with stocks.

3220

Kargaburun Düz Uçlu Opak Seri
Long Nose Pliers (Flat)

TS 60 - TS ISO 5745
DIN ISO 5745



İZELTAS YOUTUBE

Özel alaşımli çelik, Kesici ağızlar indüksiyonda sertleştirilmiş
Special steel, Cutters induction hardened

KOD CODE	L mm	L inch	g	□	TL/Ad.
3220 13 2140	140	5 1/2"	110	5	86,30
3220 13 2160	160	6 1/4"	135	5	97,55
3220 13 2180	180	7 1/8"	170	5	107,20
3220 13 2200	200	8"	205	5	113,70

3220

Kargaburun Düz Uçlu Kraft Seri
Long Nose Pliers (Flat)

TS 60 - TS ISO 5745
DIN ISO 5745



Özel alaşımli çelik, Kesici ağızlar indüksiyonda sertleştirilmiş
Special steel, Cutters induction hardened

KOD CODE	L mm	L inch	g	□	TL/Ad.
3220 13 3140	140	5 1/2"	120	5	106,55
3220 13 3160	160	6 1/4"	155	5	120,25
3220 13 3180	180	7 1/8"	185	5	132,30
3220 13 3200	200	8"	210	5	140,25

3220

Kargaburun Düz Uçlu Ergonomik Seri
Long Nose Pliers (Flat)

TS 60 - TS ISO 5745
DIN ISO 5745



Özel alaşımli çelik, Kesici ağızlar indüksiyonda sertleştirilmiş
Special steel, Cutters induction hardened

KOD CODE	L mm	L inch	g	□	TL/Ad.
3220 13 5140	140	5 1/2"	110	5	112,10
3220 13 5160	160	6 1/4"	140	5	126,75
3220 13 5180	180	7 1/8"	160	5	139,30
3220 13 5200	200	8"	170	5	147,60

3220

1000V İzoleli Elektrikçi Kargaburun Düz Uçlu
Insulated Electrician Type
Long Nose Pliers 1000V



TS 60
TS ISO 5745
DIN ISO 5745
△ 1000 V
IEC 60900



Özel alaşımli çelik, Kesici ağızlar indüksiyonda sertleştirilmiş, Krom kaplı
Special steel, Cutters induction hardened, Chrom plated

KOD CODE	L mm	L inch	g	□	TL/Ad.
3220 13 6140	140	5 1/2"	110	5	123,45
3220 13 6160	160	6 1/4"	140	5	136,50
3220 13 6180	180	7 1/8"	160	5	153,20
3220 13 6200	200	8"	170	5	159,10

3225
Kargaburun Eğri Uçlu Opak Seri
Long Nose Pliers (Bent)

TS 60 - TS ISO 5745

 Özel alaşımli çelik, Kesici ağızlar indüksiyonda sertleştirilmiş
Special steel, Cutters induction hardened

KOD CODE	L mm	L inch	g	TL/Ad.
3225 13 2160	160	6 1/4"	140	5 103,05
3225 13 2180	180	7 1/8"	170	5 116,45
3225 13 2200	200	8"	175	5 124,45

3225
Kargaburun Eğri Uçlu Kraft Seri
Long Nose Pliers (Bent)

TS 60 - TS ISO 5745

 Özel alaşımli çelik, Kesici ağızlar indüksiyonda sertleştirilmiş
Special steel, Cutters induction hardened

KOD CODE	L mm	L inch	g	TL/Ad.
3225 13 3160	160	6 1/4"	150	5 123,95
3225 13 3180	180	7 1/8"	190	5 136,10
3225 13 3200	200	8"	195	5 149,75

3020 00 2003
Opak Pense Seti 160mm (3 Parça)
Opak Pliers Set 160mm (3 Pcs)
ANAHTARLIK HEDİYELİ
YENİ NEW

KOD CODE	L mm	İÇERİK CONTENTS	TL Ad.
3020 12 2160	160	Kombine Pense Opak Seri Combination Pliers 160mm	1 291,55
3220 13 2160	160	Kargaburun Düz Uçlu Opak Seri Long Nose Pliers (Flat) 160mm	1 291,55
3700 16 2160	160	Yan Keski Opak Seri Side Cutting Pliers 160mm	1 291,55

3020 00 1002
Pense Kontrol Kalem Seti (2 Parça)
Opak Pliers Set, Voltage Tester (Flat) 2 Pcs
YENİ NEW
ANAHTARLIK HEDİYELİ

KOD CODE	L mm	İÇERİK CONTENTS	TL Ad.
3020 12 2160	160	Kombine Pense Opak Seri Combination Pliers 160mm	1 110,05
4550 17 0190	190	Elektrik Kontrol Kalem (Düz Uçlu) Voltage Tester (Flat) 190mm	1 110,05

3700

Yan Keski Opak Seri Side Cutting Pliers

TS 60 - TS ISO 5749
DIN ISO 5749



İZELTAS YOUTUBE

Özel alaşımli çelik, Kesici ağızlar indüksiyonda sertleştirilmiş
Special steel, Cutters induction hardened

KOD CODE	L mm	L inch	g	□	TL/Ad.
3700 16 2140	140	5 1/2"	165	5	88,40
3700 16 2160	160	6 1/4"	230	5	106,40
3700 16 2180	180	7 1/8"	230	5	124,15

3700

Yan Keski Kraft Seri Side Cutting Pliers

TS 60 • DIN ISO 5749
DIN ISO 5749



Özel alaşımli çelik, Kesici ağızlar indüksiyonda sertleştirilmiş
Special steel, Cutters induction hardened

KOD CODE	L mm	L inch	g	□	TL/Ad.
3700 16 3140	140	5 1/2"	190	5	106,60
3700 16 3160	160	6 1/4"	240	5	128,10
3700 16 3180	180	7 1/8"	255	5	149,25

3700

Yan Keski Ergonomik Seri Side Cutting Pliers

TS 60 - TS ISO 5749
DIN ISO 5749



Özel alaşımli çelik, Kesici ağızlar indüksiyonda sertleştirilmiş
Special steel, Cutters induction hardened

KOD CODE	L mm	L inch	g	□	TL/Ad.
3700 16 5140	140	5 1/2"	165	5	115,00
3700 16 5160	160	6 1/4"	215	5	132,95
3700 16 5180	180	7 1/8"	215	5	155,05

3700

1000V İzoleli Elektrikçi Yan Keski Insulated Electrician Type Side Cutter 1000V

TS 60
TS ISO 5749
DIN ISO 5749
⚡ 1000 V

IEC 60900



Özel alaşımli çelik, Kesici ağızlar indüksiyonda sertleştirilmiş, Krom kaplı
Special steel, Cutters induction hardened, Chrom plated

KOD CODE	L mm	L inch	g	□	TL/Ad.
3700 16 6140	140	5 1/2"	165	5	134,15
3700 16 6160	160	6 1/4"	215	5	152,30
3700 16 6180	180	7 1/8"	225	5	170,40

YAN KESKİ KRAFT SERİ / SIDE CUTTING PLIERS

Nikel üzerine krom kaplama ile
korozyon direncinde
üst seviye koruma

High corrosion resistance with chrome
over nickel plating

Isıl işlem sonrası ilave indüksiyonla sertleştirme ile
kullanım ömrü arttırılmış kesici ağızlar
Heat-treated and induction hardened cutting edges
for long lifetime

Yüksek karbonlu sıcak dövme çeliği ile
arttırılmış dayanım
High carbon forged steel for
improved durability

TSE
standartlarına
uygun üretim
Prodion acc. to
TSE standards

Düşmelere ve darbeye
dayanıklı, selüloz
asetat ergonomik sap
Impact resistant cellulose
acetate handle



İZELTAS YOUTUBE

İnce Uçlu Yan Keski (Plastikler İçin)
Side Cutter For Plastics

TS 60
TS ISO 5749



Yan Keski Ağır Tip (Çelik Tel İçin)
Side Cutter Heavy Duty (for piano wire)



Özel alaşımli çelik, Kesici ağızlar induksiyonda sertleştirilmiş, PVC izoleli
Special steel, Cutters induction hardened, PVC insulated

Özel alaşımli çelik, Kesici ağızlar induksiyonda sertleştirilmiş
Special steel, Cutters induction hardened

KOD CODE	L mm	L inch	g	TL/Ad.
3705 16 5160	160	6 1/4"	220	5 138,50

KOD CODE	L mm	L inch	g	TL/Ad.
3730 16 2160	160	6 1/4"	200	5 151,00
3730 16 2200	200	8"	320	5 196,25

3335 00 1004

Segman Pense Takımı (4 Parça)
Circlip Pliers Set (4 Pcs)



İZELTAS YOUTUBE



330112 0180
Dış Segman Pense (Düz) ● 19-60



331112 0170
Dış Segman Pense (Eğri) ● 19-60



332112 0180
İç Segman Pense (Düz) ● 19-60



333112 0170
İç Segman Pense (Eğri) ● 19-60

KOD CODE	L mm	İÇERİK CONTENTS	TL/Ad.
3301 12 0180	180	Dış Segman Pense (Düz) Circlip Pliers, External (Flat)	437,15
3311 12 0170	170	Dış Segman Pense (Eğri) Circlip Pliers, External (Bent)	
3321 12 0180	180	İç Segman Pense (Düz) Circlip Pliers, Internal (Flat)	
3331 12 0170	170	İç Segman Pense (Eğri) Circlip Pliers, Internal (Bent)	

3301

Dış Segman Pense (Düz) Circlip Pliers, External (Flat)



TS 60
DIN 5254



Krom vanadyum, Krom kaplı, PVC izoleli
Chrom vanadium, Chrom plated, PVC insulated

KOD CODE	L mm	⌀	g	□	TL/Ad.
3301 12 0140	140	10 - 25	90	5	103,00
3301 12 0180	180	19 - 60	195	5	108,55
3301 12 0225	225	40 - 100	235	5	135,70
3301 12 0295	295	85 - 140	445	5	230,15

3311

Dış Segman Pense (Eğri) Circlip Pliers, External (Bent)



TS 60
DIN 5254



Krom vanadyum, Krom kaplı, PVC izoleli
Chrom vanadium, Chrom plated, PVC insulated

KOD CODE	L mm	⌀	g	□	TL/Ad.
3311 12 0125	125	10 - 25	105	5	115,10
3311 12 0170	170	19 - 60	190	5	121,25
3311 12 0210	210	40 - 100	250	5	139,30
3311 12 0275	275	85 - 140	445	5	241,65

3310

Çakma Uçlu Dış Segman Pense (Eğri) Circlip Pliers, External Insert Tips (Bent)



Krom vanadyum, Siyah oksit kaplı, PVC izoleli
Chrom vanadium, Black finish, PVC insulated

KOD CODE	L mm	⌀	g	□	TL/Ad.
★3310 12 0170	170	19 - 60	190	5	105,15

3321

İç Segman Pense (Düz) Circlip Pliers Internal (Flat)



TS 60
DIN 5256



Krom vanadyum, Krom kaplı, PVC izoleli
Chrom vanadium, Chrom plated, PVC insulated

KOD CODE	L mm	⌀	g	□	TL/Ad.
3321 12 0140	140	12 - 25	100	5	94,80
3321 12 0180	180	19 - 60	185	5	100,05
3321 12 0225	225	40 - 100	250	5	124,55
3321 12 0310	310	85 - 140	445	5	213,75

3331

İç Segman Pense (Eğri) Circlip Pliers Internal (Bent)



TS 60
DIN 5256



Krom vanadyum, Krom kaplı, PVC izoleli
Chrom vanadium, Chrom plated, PVC insulated

KOD CODE	L mm	⌀	g	□	TL/Ad.
3331 12 0130	130	12 - 25	105	5	101,95
3331 12 0170	170	19 - 60	185	5	107,30
3331 12 0210	210	40 - 100	250	5	133,95
3331 12 0290	290	85 - 140	440	5	229,95

3320

Çakma Uçlu İç Segman Pense (Düz) Circlip Pliers, Inside Driven Tips (Flat)



Krom vanadyum, Siyah oksit kaplı, PVC izoleli
Chrom vanadium, Black finish, PVC insulated

KOD CODE	L mm	⌀	g	□	TL/Ad.
★3320 12 0140	140	8 - 25	100	5	82,20
★3320 12 0225	225	40 - 100	250	5	108,05

3400

Sübab Segman Pense
Pliers for Valve Seals



KOD CODE	L mm	L inch	g	TL/Ad.
★3400 12 0275	275	11"	350	5 231,40

3420

Hortum Kelepçe Pensesi
Hose Clamp Pliers



KOD CODE	L mm	L inch	g	TL/Ad.
3420 12 0220	220	8 3/4"	185	5 177,55

3405

Piston Segman Pense
Piston Ring Pliers



KOD CODE	L mm	ÖLÇÜ	g	TL/Ad.
★3405 12 0225	265	Ø60 - Ø160	200	5 161,80

3425

Hortum Kelepçe Pensesi (Sıkıştırma Tipi)
Hose Clamp Pliers



KOD CODE	L mm	L inch	g	TL/Ad.
3425 12 0220	235	9 1/4"	355	5 181,95

3415

Fren Yay Pensesi
Brake Spring Pliers



Krom vanadyum, Krom kaplı
Chrom vanadium, Chrom plated

KOD CODE	L mm	L inch	g	TL/Ad.
★3415 12 0320	320	13"	430	5 229,45
★3415 12 0525	525	20"	1190	5 531,10

3852

Delik Zımba
Revolving Punch Pliers



Ölçü / Size ø2 - ø2.5 - ø3 - ø3.5 - ø4 - ø4.5

KOD CODE	L mm	L inch	g	TL/Ad.
3852 24 0225	225	9"	270	5 115,90

3715
Tek Ağızlı Kablo Kesici
Cable Cutter

Özel alaşımlı çelik, Kesici ağızlar indüksiyonda sertleştirilmiş, PVC izoleli
Special steel, Cutters induction hardened, PVC insulated

KOD CODE	L mm	L inch	g		TL/Ad.
3715 16 0165	165	6 1/4	210	5	114,05

3715
1000V İzoleli Tek Ağızlı Kablo Kesici
Cable Cutter 1000V

⚡ 1000 V
 IEC 60900



Özel alaşımlı çelik, Kesici ağızlar indüksiyonda sertleştirilmiş
Special steel, Cutters induction hardened

KOD CODE	L mm	L inch	g		TL/Ad.
3715 16 6165	165	6 1/4	230	5	134,55

Çift Ağızlı Kablo Kesici
Cable Cutter, Double Cutter

Özel alaşımlı çelik, Kesici ağızlar induksiyonda sertleştirilmiş, PVC izoleli
Special steel, Cutters induction hardened, PVC insulated

KOD CODE	L mm	L inch	g	TL/Ad.
3720 16 0220	220	9"	320	5 152,95

Testere Çaprazı
Saw - Setting Pliers

TSEK



Özel alaşımlı çelik, İndüksiyonda sertleştirilmiş,
Natural Vernikli, PVC izoleli
Special steel, induction hardened, PVC insulated

KOD CODE	L mm	L inch	g	TL/Ad.
3860 26 0180	180	7 1/8"	245	5 123,50



3550

Elektronikçi Yan Keski
Electronic Diagonal Side Cutting Pliers



Özel alaşımli çelik
Special steel

KOD CODE	L mm	g		TL/Ad.
3550 14 0125	125	76	5	113,15

3553

Elektronikçi Düz Uçlu Kargaburun
Electronic Flat Nose Pliers



Özel alaşımli çelik
Special steel

KOD CODE	L mm	g		TL/Ad.
3553 14 0150	150	88	5	112,85

3551

Elektronikçi Tepe Keski
Electronic End Cutting Pliers



Özel alaşımli çelik
Special steel

KOD CODE	L mm	g		TL/Ad.
3551 14 0125	125	77	5	113,15

3554

Elektronikçi Uzun Kargaburun
Electronic Long Nose Pliers



Özel alaşımli çelik
Special steel

KOD CODE	L mm	g		TL/Ad.
3554 14 0150	150	88	5	112,85

3552

Elektronikçi Yuvarlak Uçlu Kargaburun
Electronic Round Nose Pliers



Özel alaşımli çelik
Special steel

KOD CODE	L mm	g		TL/Ad.
3552 14 0125	125	78	5	113,15

3555

Elektronikçi Sivri Uçlu Düz Kargaburun
Electronic Needle Flat Nose Pliers



Özel alaşımli çelik
Special steel

KOD CODE	L mm	g		TL/Ad.
3555 14 0150	150	86	5	112,85

3556

Elektronikçi Sivri Uçlu Eğri Kargaburun
Electronic Needle Bent Nose Pliers



Özel alaşımli çelik
Special steel

KOD CODE	L mm	g	TL/Ad.
3556 14 0150	150	85	5 112,85

3557

Elektronikçi Pense
Electronic Pliers



Özel alaşımli çelik
Special steel

KOD CODE	L mm	g	TL/Ad.
3557 14 0125	125	80	5 113,15

3560 00 2104

Elektronikçi Keski ve Pense Seti (4 Parça)
Electronic Cutter & Pliers Set (4 Pcs)



KOD CODE	L mm	İÇERİK CONTENTS	TL Ad.
3550 14 0125	125	Elektronikçi Yan Keski Electronic Diagonal Side Cutting Pliers	1
3551 14 0125	125	Elektronikçi Tepe Keski Electronic End Cutting Pliers	1
3554 14 0150	150	Elektronikçi Uzun kargaburun Electronic Long Nose Pliers	1 452,30
3557 14 0125	125	Elektronikçi Pense Electronic Pliers	1

3565 00 2104

Elektronikçi Kargaburun Seti (4 Parça)
Electronic Long Nose Pliers Set (4 Pcs)



KOD CODE	L mm	İÇERİK CONTENTS	TL Ad.
3552 14 0125	125	Elektronikçi Yuvarlak Uçlu Kargaburun Electronic Round Nose Pliers	1
3553 14 0150	150	Elektronikçi Düz Uçlu Kargaburun Electronic Flat Nose Pliers	1 451,70
3555 14 0150	150	Elektronikçi Sivri Uçlu Düz Kargaburun Electronic Needle Nose Pliers	1
3556 14 0150	150	Elektronikçi Sivri Uçlu Eğri Kargaburun Electronic Bent Needle Nose Pliers	1

(★) İşaretli olan ürünler stoklarla sınırlıdır.
Limited with stocks.

3800

Kerpeten Carpenter Pincers

TS 60 - TS ISO 9243
DIN ISO 9243



Özel alaşımli çelik, Kesici ağızlar indüksiyonda sertleştirilmiş, PVC izoleli
Special steel, Cutters induction hardened, PVC insulated

KOD CODE	L mm	L inch	g	TL/Ad.
3800 15 0160	160	6 1/4"	220	84,15
3800 15 0180	180	7 1/8"	295	87,05
3800 15 0200	200	8"	330	116,10
3800 15 0250	250	10"	530	126,50

3830

Betoncu Kerpeteni Tower Pincers

TS 60 • TS ISO 9242
DIN ISO 9242



Özel alaşımli çelik, Kesici ağızlar indüksiyonda sertleştirilmiş, PVC izoleli
Special steel, Cutters induction hardened, PVC insulated

KOD CODE	L mm	L inch	g	TL/Ad.
3830 15 0225	225	9"	345	104,45
3830 15 0250	250	10"	395	115,40
3830 15 0280	280	11"	450	129,15

3831

Betoncu Kerpeteni Yaylı Tower Pincers with spring

TS 60 - TS ISO 9242
DIN ISO 9242



Özel alaşımli çelik, Kesici ağızlar indüksiyonda sertleştirilmiş, PVC izoleli
Special steel, Cutters induction hardened, PVC insulated

KOD CODE	L mm	L inch	g	TL/Ad.
3831 15 0280	280	11"	455	148,15

3835

Ağır Tip Betoncu Kerpeteni Heavy Duty Tower Pincers

TS 60 - TS ISO 9242
DIN ISO 9242



İZELTAS YOUTUBE

Özel alaşımli çelik, Kesici ağızlar indüksiyonda sertleştirilmiş, PVC izoleli
Special steel, Cutters induction hardened, PVC insulated

KOD CODE	L mm	L inch	g	TL/Ad.
3835 15 0280	280	11"	435	146,85

3850

Danalya Shoemaker Pliers



Özel alaşımli çelik, İndüksiyonda sertleştirilmiş, Siyah Oksit kaplı
Special steel, Induction hardened, Black finish

KOD CODE	L mm	L inch	g	TL/Ad.
3850 12 0200	200	8"	360	182,30



IZELTAS®

1000V İZOLELİ ALETLER

1000V INSULATED TOOLS



İZELTAŞ YOUTUBE

VDE BELGELİ ÜRÜNLERİMİZ / VDE CERTIFIED PRODUCTS



- » El aletleri sektörünün lider markası İZELTAŞ'ın VDE belgeli ürünleri elektrik sektöründe fark yaratıyor.
- Bu ürünler elektrik sektöründe 1000V izolasyon sağlamak için özel olarak tasarlanmış yanmaz sapları ile kullanıcıya güven verir.
 - Elektrik akımının bulunduğu alanlarda güvenli kullanım sağlar.
 - Yanma, 1000V elektrik direnci, soğuk ve sıcak havalarda sap sökme deneyleri başta olmak üzere pek çok özel testten geçirilen ürünler, Alman VDE firmasından onaylıdır.
 - Ergonomik sap tasarımı ile tutuş ve kullanım kolaylığı sağlar.



- » As the leading brand in hand tools sector, CDE certified products of İZELTAŞ make a difference in electrical sector.
- These products assure the user with their handles specially designed to provide isolation up to 1000 V.
 - They provide safe use in areas with electrical current.
 - The products are certified by German VDE institution, being subjected to various tests particularly including fire resistance, 1000 V electrical resistance and handle detachment tests in hot and cold air conditions.
 - They provide ease of grip and use with an ergonomic design.



Çalışma sırasında nelere dikkat edilmelidir?

- Elektrik akımının var olduğu alanlarda yalnızca özel eğitimli ve alanında uzman kişiler çalışmalıdır.
- Her kullanım öncesinde VDE belgeli ürünlerde ve izolelerinde hasar olup olmadığı kontrol edilmelidir.
- VDE belgeli ürünler amacı dışında ya da birleştirilerek kullanılmamalıdır.
- VDE belgeli ürünler ile koruyucu ekipmanlarınızı da güvenlik amacıyla kullanmalısınız.



Important points for use

- Only specially trained and expert personnel should engage in work in areas with electrical current.
- Before each use VDE certified products and their isolation materials should be checked against damage.
- VDE certified products should not be used outside their purpose or in combination.
- Protective equipment should also be used to protect personnel in addition to VDE certified products.



**VDE belgeli ürünlerimiz,
ilgili uluslararası standartlara göre
kontrol edildikten sonra ek olarak
beş ayrı teste tabi tutulur**

- » 1- Voltaj Testi: 3 dakika boyunca 10.000V'a tabi tutulan izoleli el aletinde kaçak yada elektrik akımı atlaması olmamalıdır.
- 2- Soğuk Şoklama Testi : -24 derece 2 saat bekletilmiş (şoklanmış) el aletine 60-80 cm yükseklikten 600gr ağırlık ile darbeler uygulanır. İzolede kırılma ya da çatlama olmamalıdır.
- 3- Dayanıklılık Testi: +70 derece 1 hafta bekletilmiş el aletine 50kg yük ile sap sökme testi uygulanır. Sap yerinden çıkmamalıdır.
- 4- Geçirgenlik Testi: 5000V elektrik akımına karşı 3 dakika boyunca 2kg sivri uçlu ağırlıkta baskı yapılarak elektrik verilir. Kaçak ya da elektrik atlaması olmamalıdır.
- 5- Yanma Testi: Yüksek yoğunluktaki alev 20 saniye maruz bırakılarak teste tabi tutulur. Alevden uzaklaştırılan izole yanmaya devam etmemelidir.

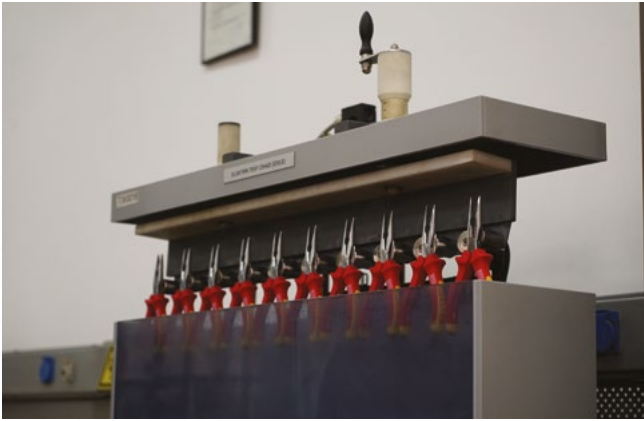

**Our VDE certified products
are controlled in accord with the applicable
international standards and then are
subjected to five different tests:**

- » 1- Voltage Test: No residual current or electrical arc should be seen on the isolated hand tool subjected to 10,000 V for 3 minutes.
- 2- Cold Shock Test: Hand tools left in -24 °C for 2 hours (shocked) are subjected to impacts with a 600 gr weight dropped from a height of 60-80 cm. No breakage or cracking should be seen on the isolation material.
- 3- Durability Test: Hand tools left in +70 °C for 1 week are subjected to handle detachment test with a load of 50 kg. The handle should not detach.
- 4- Perviousness Test: Pointed tips under 2 kg load are used to apply 5000 V electrical current for 3 minutes. There should be no residual current or electrical arc.
- 5- Fire Test: The tool is subjected to high intensity flames for 20 seconds. After contact with the flame is ended the isolation material should not continue burning.

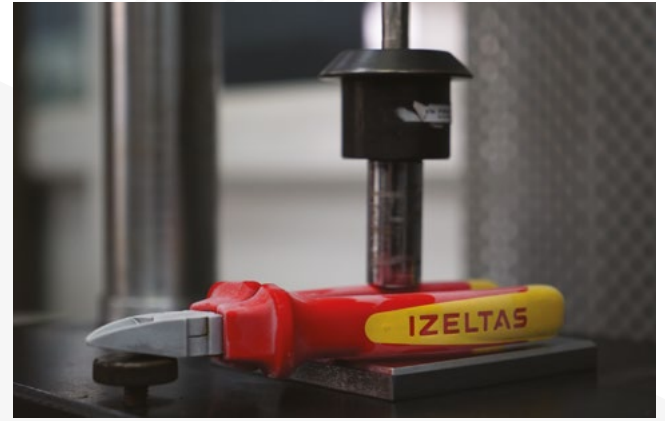



Güçlü kavrama sağlayan
tırnaklı tutma yüzeyleri
Toothed surface for strong grip

Isıl işlem sonrasında indüksiyonda
sertleştirme ile kullanım
ömrü artırılmış kesici ağızlar
Heat-treated and induction hardened
cutting edges for long lifetime

Nikel üzerine krom kaplama ile
korozyon direncinde
üst seviye koruma
High corrosion resistance
with chrome over nickel plating

Yüksek karbonlu
sıcak dövme çeliği
ile arttırılmış
dayanım
High carbon forged
steel for improved
durability

VDE/GS belgeli, 1000V dayanımlı,
sert plastikten ve konforlu tutuş
sağlayan yumuşak elastomer
malzemeden imal edilmiş
dayanımı yüksek çift
komponentli ergonomik sap
VDE/GS certified, insulated for 1000V
usage. Two component ergonomic
handle with high strength and
soft grip plastic



0255

Süper İzole Çatal Bir Ağız Anahtar (mm)
Single Ended Open Jaw Wrench
Super Insulated (mm)

IEC 60900
⚡ 1000 V



Krom vanadyum, Krom kaplı, Kalın PVC izoleli
Chrom vanadium, Chrom plated, Triple PVC insulated

KOD CODE	mm	L mm	g		TL/Ad.
0255 01 0010	10	110	40	10	42,80
0255 01 0011	11	120	45	10	45,20
0255 01 0012	12	130	50	10	47,20
0255 01 0013	13	140	60	10	50,80
0255 01 0014	14	155	75	10	52,75
0255 01 0017	17	170	100	10	64,75
0255 01 0019	19	185	150	10	76,00
0255 01 0022	22	200	200	10	102,20
0255 01 0024	24	220	280	10	125,05

0435

Süper İzoleli Yıldız Bir Ağız Anahtar (mm)
Single Ended Ring Wrench
Super Insulated (mm)

IEC 60900
⚡ 1000 V



Krom vanadyum, Krom kaplı, Kalın PVC izoleli
Chrom vanadium, Chrom plated, Triple PVC insulated

KOD CODE	mm	L mm	g		TL/Ad.
0435 03 0010	10	170	100	10	57,05
0435 03 0011	11	175	110	10	57,05
0435 03 0012	12	180	130	10	64,75
0435 03 0013	13	185	150	10	64,75
0435 03 0014	14	190	180	10	67,95
0435 03 0017	17	205	220	10	77,00
0435 03 0019	19	220	270	10	91,85
0435 03 0022	22	245	310	10	100,70
0435 03 0024	24	270	420	10	134,55

2400

1000V İzoleli Üniversal Fort Pense
Insulated Type Waterpump
Pliers Universal 1000V



TS 60
TS ISO 8976
IEC 60900
⚡ 1000 V



Krom vanadyum, Krom kaplı, çift komponent saplı
Chrom vanadium, Chrom plated, Two component handle

KOD CODE	L mm	L inch	mm	g		TL/Ad.
2400 11 6240	240	9 1/2"	35	370	5	163,55

3020

1000V İzoleli Elektrikçi Kombine Pense
Insulated Electrician Type
Combination Pliers 1000V



TS 60
TS ISO 5746
DIN ISO 5746

⚡ 1000 V
IEC 60900



Özel alaşımlı çelik, Kesici ağızlar indüksiyonda sertleştirilmiş, Krom kaplı
Special steel, Cutters induction hardened, Chrom plated



KOD CODE	L mm	L inch	g		TL/Ad.
3020 12 6160	160	6 1/4"	205	5	120,65
3020 12 6180	180	7 1/8"	260	5	129,15
3020 12 6200	200	8"	345	5	145,80

1000V İzoleli Elektrikçi Kargaburun Düz Uçlu Insulated Electrician Type Nose Pliers 1000V



TS 60
TS ISO 5745
DIN ISO 5745
⚡ 1000 V
IEC 60900



Özel alaşımli çelik, Kesici ağızlar indüksiyonda sertleştirilmiş, Krom kaplı
Special steel, Cutters induction hardened, Chrom plated

KOD CODE	L mm	L inch	g	TL/Ad.
3220 13 6140	140	5 1/2"	110	123,45
3220 13 6160	160	6 1/4"	140	136,50
3220 13 6180	180	7 1/8"	160	153,20
3220 13 6200	200	8"	170	159,10

1000V İzoleli Elektrikçi Yan Keski Insulated Electrician Type Side Cutter 1000V



TS 60
TS ISO 5749
DIN ISO 5749
⚡ 1000 V

IEC 60900



Özel alaşımli çelik, Kesici ağızlar indüksiyonda sertleştirilmiş, Krom kaplı
Special steel, Cutters induction hardened, Chrom plated

KOD CODE	L mm	L inch	g	TL/Ad.
3700 16 6140	140	5 1/2"	165	134,15
3700 16 6160	160	6 1/4"	215	152,30
3700 16 6180	180	7 1/8"	225	170,40

1000V İzoleli Tek Ağızlı Kablo Kesici Cable Cutter 1000V

⚡ 1000 V
IEC 60900



Özel alaşımli çelik, Kesici ağızlar indüksiyonda sertleştirilmiş
Special steel, Cutters induction hardened

KOD CODE	L mm	L inch	g	TL/Ad.
3715 16 6165	165	6 1/4"	150	134,55

1000V İzoleli Elektrikçi Seti (3 Parça) 1000V Insulated Tool Set (3 Pcs)



KOD CODE	İÇERİK CONTENTS	TL/Ad.
3020 12 6160	160 mm 1000V İzoleli Elektrikçi Kombine Pense Insulated Electrician Type Combination Pliers	1
3220 13 6160	160 mm 1000V İzoleli Elektrikçi Kargaburun Düz Uçlu Insulated Electrician Type Nose Pliers	1
3700 16 6160	160 mm 1000V İzoleli Elektrikçi Yan Keski Insulated Electrician Type Side Cutter	1
		409,45

4140

1000V İzoleli Elektrikçi Düz Uçlu Tornavida Insulated Electrician Type Flat Screwdriver 1000V

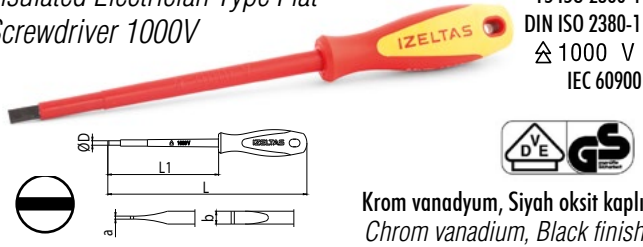

TS 59
TS ISO 2380-1
DIN ISO 2380-1
△ 1000 V
IEC 60900



Krom vanadyum, Siyah oksit kaplı
Chrom vanadium, Black finish

KOD CODE	ØDxL1 mm	⊖		L mm	g	□	TL/Ad.
		a mm	b mm				
4140 17 2575	2.5x75	0.4	2.5	150	25	10	19,40
4140 17 4100	4x100	0.8	4	185	40	10	22,80
4140 17 5512	5.5x125	1	5.5	220	70	10	30,05
4140 17 6515	6.5x150	1.2	6.5	245	90	10	33,60

4145

1000V İzoleli Elektrikçi Yıldız Uçlu Tornavida Insulated Electrician Type Phillips Screwdriver 1000V



TS 59
TS 59-5 ISO 8764
DIN ISO 8764
△ 1000 V
IEC 60900



Krom vanadyum, Siyah oksit kaplı
Chrom vanadium, Black finish

KOD CODE	ØDxL1 mm	⊕	L mm	g	□	TL/Ad.
4145 18 0360	3x60	Ph0	135	25	10	20,20
4145 18 4580	4.5x80	Ph1	165	45	10	28,55
4145 18 6100	6x100	Ph2	195	70	10	33,60

4140

1000V İzoleli Elektrikçi Tornavida Seti (6 Parça) Insulated Electrician Set (6 Pcs) Screwdriver 1000V



KOD CODE	İÇERİK CONTENTS	g	□	TL/Ad.
4140 00 9106	2.5x75 - 4x100	340	6	168,00
	5.5x125 - 6.5x150			
	Düz uçlu / Flat			
	4.5x80 - 6x100			
	Yıldız uçlu / Phillips			

4773

1000V Süngüsü İzoleli Lokma Uçlu Tornavida Nut Spinner, Electrician Blade Insulated 1000V

DIN 3125

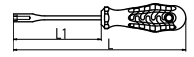

Krom vanadyum, iki komponent saplı
Chrome vanadium, Two component handle

KOD CODE	⊖ mm	L mm	L1 mm	g	□	TL/Ad.
4773 19 0040	4	220	125	90	10	62,35
4773 19 0050	5	220	125	90	10	62,35
4773 19 0055	5.5	220	125	90	10	62,35
4773 19 0060	6	220	125	90	10	62,35
4773 19 0070	7	230	125	110	10	66,85
4773 19 0080	8	230	125	120	10	66,85
4773 19 0090	9	230	125	125	10	72,20
4773 19 0100	10	230	125	125	10	72,20
4773 19 0110	11	230	125	140	10	78,80
4773 19 0120	12	230	125	145	10	84,55
4773 19 0130	13	230	125	150	10	91,10
4773 19 0140	14	230	125	150	10	100,75

4773

1000V Süngüsü İzoleli Lokma Uçlu Tornavida Takımı (8 Parça) Nut Spinner, Electrician Blade Insulated Set (8 Pcs) 1000V



KOD CODE	İÇERİK CONTENTS	g	□	TL/Ad.
4773 00 8108	6 - 7 - 8 - 9 - 10 - 11 - 12 - 13	2225	8	594,90

1000V Sngs İzoleli Manyetik Bits Tutucu Tornavida
Screwdriver, Magnetic Bit Holder Insulated
1000V

⚡ 1000 V
IEC 60900

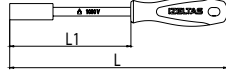

KOD CODE	∅ mm	L mm	L1 mm	g	TL/Ad.
4783 19 6120	6.3	230	120	115	10, 70,10

1000V İzoleli Elektrikçi Seti (5 Parça)
1000V Insulated Tool Set (5 Pcs)



İZELTAS YOUTUBE

KOD CODE	İÇERİK CONTENTS	TL/Ad.
3020 12 6180	180 mm 1000V İzoleli Elektrikçi Kombine Pense Insulated Electrician Type Combination Pliers 1000V	1
3220 13 6200	200 mm 1000V İzoleli Elektrikçi Kargaburun Insulated Electrician Type Nose Pliers	1
3700 16 6160	160 mm 1000V İzoleli Elektrikçi Yan Keski Insulated Electrician Type Nose	1 504,20
4140 17 5512	5.5x125 1000V Elektrikçi Dz Uçlu Tornavida Insulated Electrician Type Flat Screwdriver 1000V	1
4145 18 6100	6x100 1000V İzoleli Elektrikçi Yıldız Uçlu Tornavida Insulated Electrician Type Phillips Screwdriver 1000V	1

19" Plastik Takım Çantası Elektrikçi Set (23 Parça)
Plastic Tool Box for Electrician 19" (23 Pcs)

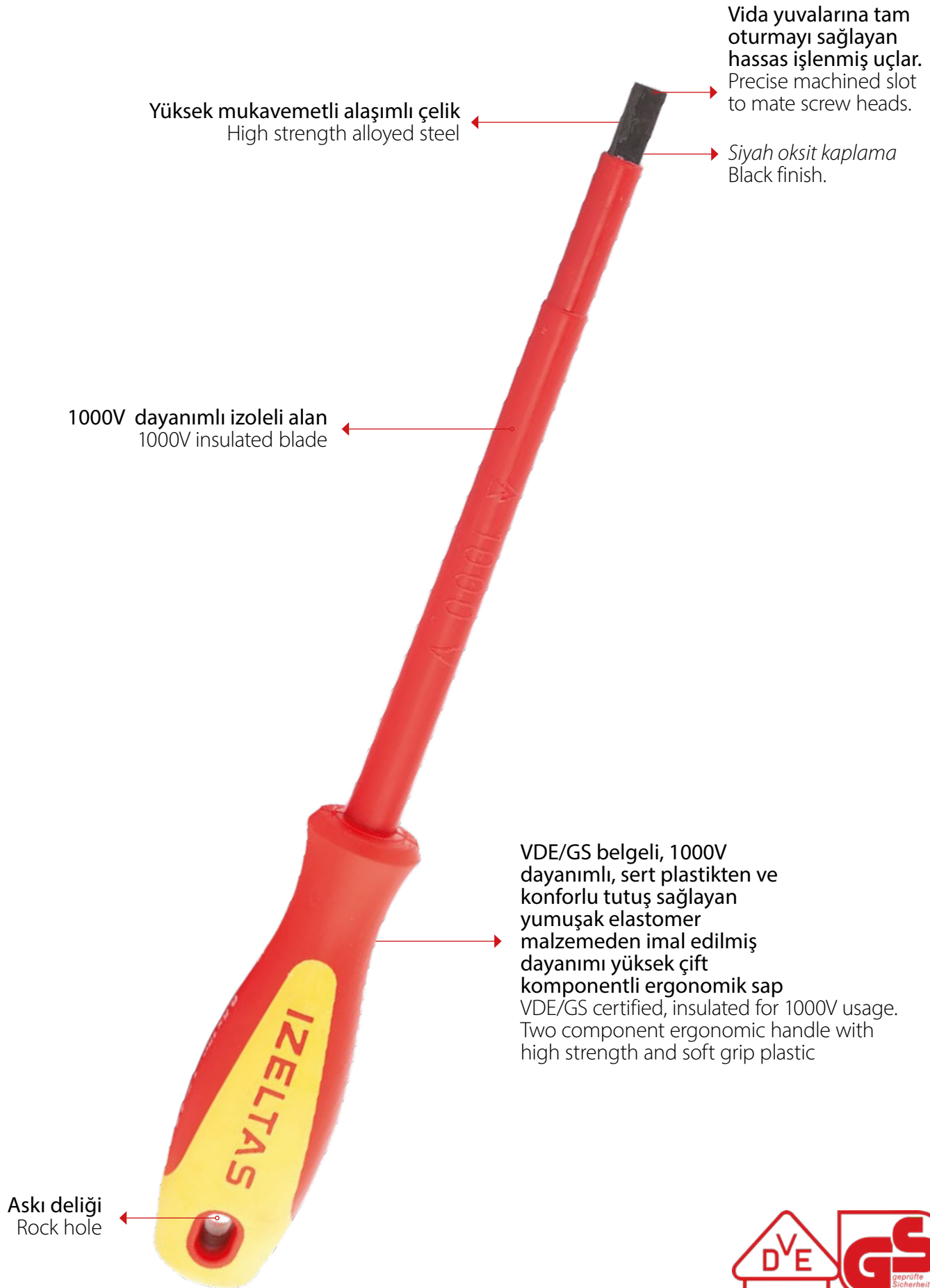

KOD CODE	İÇERİK CONTENTS	TL/Ad.
8440 33 1019	19" Plastik Takım Çantası Plastic Tool Box	1
3700 16 6160	160 mm 1000V İzoleli Elektrikçi Yan Keski Insulated Electrician Type Side Cutter 1000V	1
3020 12 6180	180 mm 1000V İzoleli Elektrikçi Kombine Pense Insulated Electrician Type Combination Pliers 1000V	1
3220 13 6160	160 mm 1000V İzoleli Elektrikçi Kargaburun Dz Uçlu Insulated Electrician Type Nose Pliers 1000V	1
4773 19 0100	1000V Sngs İzoleli Lokma Uçlu Tornavida 10mm Nut Spinner, Electrician Blade Insulated 1000V	1
4773 19 0130	1000V Sngs İzoleli Lokma Uçlu Tornavida 13mm Nut Spinner, Electrician Blade Insulated 1000V	1
3715 16 6165	165mm 1000V İzoleli Elektrikçi Tek Ağız Kablo Kesici Cable Cutter 1000V	1
4520 18 0360	3x60 Klemens Yıldız Tornavida Electronic Screwdriver, Phillips	1 1101,05
4520 18 0480	4x80 Klemens Yıldız Tornavida Electronic Screwdriver, Phillips	1
4500 17 0380	3x80 Klemens Dz Tornavida Electronic Screwdriver, Flat	1
4500 17 0480	4x80 Klemens Dz Tornavida Electronic Screwdriver, Flat	1
4140 17 4100	4x100 1000V İzoleli Elektrikçi Dz Tornavida Insulated Electrician Type Flat Screwdriver 1000V	1
4145 18 4580	4,5x80 1000V İzoleli Elektrikçi Yıldız Tornavida Insulated Electrician Type Phillips Screwdriver 1000V	1
4145 18 6100	6x100 1000V İzoleli Elektrikçi Yıldız Tornavida Insulated Electrician Type Phillips Screwdriver 1000V	1
4550 17 0190	190 mm Kontrol Kalem Voltage Tester Flat	1
4560 18 0190	190 mm Yıldız Kontrol Kalem Voltage Tester Phillips	1
4783 19 6120	6.3x120 1000V İzoleli Elektrikçi Manyetik Bits Tutucu Tornavida Screwdriver, Magnetic Bit Holder Insulated 1000V	1
4800 00 8106	6 lı Bits Set (25 mm) Bit Set 6 Pcs	6

1000V ELEKTRİKÇİ DÜZ TORNAVİDA / INSULATED ELECTRICIAN TYPE PLAT SCREWDRIVER 1000V

Yüksek mukavemetli alaşımlı çelik
High strength alloyed steel

Vida yuvalarına tam oturmayı sağlayan hassas işlenmiş uçlar.
Precise machined slot to mate screw heads.

Siyah oksit kaplama
Black finish.

1000V dayanımlı izoleli alan
1000V insulated blade

VDE/GS belgeli, 1000V dayanımlı, sert plastikten ve konforlu tutuş sağlayan yumuşak elastomer malzemeden imal edilmiş dayanımı yüksek çift komponentli ergonomik sap
VDE/GS certified, insulated for 1000V usage. Two component ergonomic handle with high strength and soft grip plastic

Askı deliği
Rock hole





İZELTAS®

TORNAVİDA VE ALLEN ANAHTARLAR

SCREWDRIVERS AND HEX KEY WRENCHES

Tornavidalar
Screwdrivers

Kontrol Kalemleri
Testers

Bits Uçlar ve Aparatları
Bits

Allen Anahtarlar
Hex Key Wrenches

SCREWDRIVERS, HEX KEY
WRENCHES

TORNAVİDALAR
ALLEN
ANAHTARLAR



İZELTAS YOUTUBE

ELEKTRİK KONTROL KALEMİ/VOLTAGE TESTER

Tam sızdırmazlık sağlayan
açılmayan pirinç kapak
Tightly pressed brass cover

110V-220V arasında
çalışan elektrik direnci ve
kolay görünebilen
neon lamba
Neon lamp working in the
range of 110V-220V

Elektrik yalıtkanlığı
sağlayan, darbe dayanımı
yüksek şeffaf sap
High insulation and impact
resistant clear cellulose
handle

izoleli süngü
insulated blade

Metal yüzeye basılı logo
Logo marked on the
innermetal surface

Yüksek tork
mukavemetine
sahip, alaşımli çelik
(İzolesiz uç kısmının
uzunluğu15mm)
High torque strength
alloyed steel
(non-insulated blade
tip length 15mm)

Nikel kaplama ile korozyon direncinde üst
seviye koruma
High corrosion resistance with nickel plating

Vida yuvalarına tam oturmayı sağlayan
hassas işlenmiş uçlar
Precise machined slot to mate screw heads



İZELTAS YOUTUBE

4550

Elektrik Kontrol Kalemi (Düz Uçlu)
Voltage Tester (Flat)

TS 13108



İZELTAS YOUTUBE

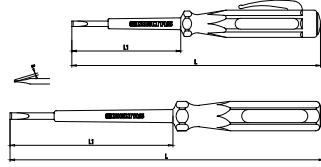

Krom vanadyum, Nikel kaplı,
Chrom vanadium, Nickel plated,

KOD CODE	L mm	⊖		L1 mm	g	TL/ Ad.
		a mm	b mm			
4550 17 0135	135	0.5	3	60	20	10
4550 17 0190	190	0.8	4	100	40	10

4555

Master Kontrol Kalemi (Düz Uçlu)
Voltage Tester Master (Flat)

TS 13108

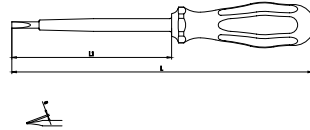

Krom vanadyum, Nikel kaplı
Chrom vanadium, Nickel plated.

KOD CODE	L mm	⊖		L1 mm	g	TL/ Ad.
		a mm	b mm			
4555 17 0165	165	0.5	3.5	88	40	10

4560

Elektrik Kontrol Kalemi (Yıldız Uçlu)
Voltage Tester Phillips

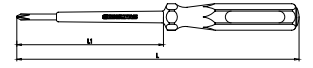
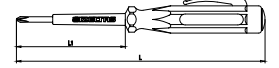

Krom vanadyum, Nikel kaplı
Chrom vanadium, Nickel plated

KOD CODE	L mm	L1 mm	+	g	TL/ Ad.
4560 18 0190	190	100	Ph0	40	10

4565

Oto Kontrol Kalemi
Car Voltage Tester

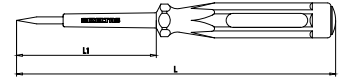

Krom vanadyum, Krom kaplı
Chrom vanadium, Chrom plated

Tüm otomobil ve ağır vasıta araçlarda 6-24V arası elektrik tesisatının kontrol edilmesinde kullanılır. Sivri uçlu olması sebebiyle kablo ve soketleri yerinden sökmeden kontrol kolaylığı sağlar.

Tool is used to control 6-24V electrical wiring in all cars and heavy duty vehicles. With its point tip, wires and sockets are not required to be disassembled.

KOD CODE	L mm	L1 mm	Kablo L (m)	g	TL/ Ad.

Kraft Seri Düz Uçlu Tornavida
Screwdriver, Kraft, Flat

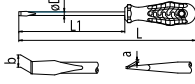
 TS ISO 2380 - 1
 DIN ISO 2380-1

Krom vanadyum, Krom kaplı, Ucu siyah oksit, Selüloz asetat saplı
Chrom vanadium, Chrom plated and black tip, Cellulose acetate handle

KOD CODE	øDxL1 mm	⊖		L mm	g	□	TL/Ad.
		a mm	b mm				
4100 17 0340	3x40	0.5	3	105	20	10	15,10
4100 17 0380	3x80	0.5	3	155	35	10	16,05
4100 17 0480	4x80	0.8	4	165	50	10	17,35
4100 17 4100	4x100	0.8	4	185	50	10	20,10
4100 17 0580	5x80	1.0	5.5	175	70	10	21,25
4100 17 5100	5x100	1.0	5.5	195	75	10	23,40
4100 17 5125	5x125	1.0	5.5	220	80	10	26,75
4100 17 5150	5x150	1.0	5.5	245	80	10	29,15
4100 17 6100	6x100	1.2	6.5	195	85	10	24,00
4100 17 6125	6x125	1.2	6.5	220	90	10	27,50
4100 17 6150	6x150	1.2	6.5	245	95	10	30,15
4100 17 6175	6x175	1.2	6.5	270	100	10	38,75
4100 17 7125	7x125	1.2	8	230	120	10	30,60
4100 17 7150	7x150	1.2	8	255	130	10	35,35
4100 17 7175	7x175	1.2	8	280	135	10	40,55
4100 17 8150	8x150	1.6	10	255	145	10	40,20
4100 17 8175	8x175	1.6	10	280	150	10	42,85
4100 17 8200	8x200	1.6	10	305	160	10	52,45
4100 17 9200	9x200	2.0	12	305	190	10	55,95
4100 17 1125	11x250	2.5	14	365	305	10	71,10

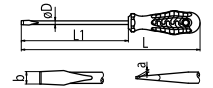

Kraft Seri Düz Uçlu Tornavida Takımı (8 Parça)
Screwdriver, Flat, Kraft Set (8 Pcs)

KOD CODE	İÇERİK CONTENTS	g	□	TL/Ad.
4100 00 8108	3x80 - 4x80 - 4x100 5x100 - 5x125 - 6x100 6x125 - 6x150 ⊖ Düz uçlu / Flat	550	8	185,30

Kraft Seri Süngüsü Uzun Düz Uçlu Tornavida
Screwdriver, Kraft, Flat, Long

Krom vanadyum, Krom kaplı, Ucu siyah oksit, Selüloz asetat saplı
Chrom vanadium, Chrom plated and black tip, Cellulose acetate handle

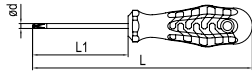
KOD CODE	øDxL1 mm	⊖		L mm	g	□	TL/Ad.
		a mm	b mm				
★ 4100 17 4250	4x250	0.8	4	335	65	10	41,90
4100 17 4300	4x300	0.8	4	385	70	10	49,50
4100 17 5250	5x250	1.0	5.5	345	95	10	55,30
★ 4100 17 5300	5x300	1.0	5.5	395	105	10	50,05
4100 17 5350	5x350	1.0	5.5	445	115	10	62,50
4100 17 6350	6x350	1.2	6.5	445	125	10	66,15

4120
Kraft Seri Yıldız Uçlu Tornavida
Screwdriver, Kraft, Phillips

 TS 59 - 5 ISO 8764-1
 DIN ISO 8764-1

Krom vanadyum, Krom kaplı, Ucu siyah oksit, Selüloz asetat saplı
Chrom vanadium, Chrom plated and black tip, Cellulose acetate handle.

KOD CODE	ØdxL1 mm	+	L mm	g	TL/Ad.
4120 18 0360	3x60	Ph0	135	30	17,00
4120 18 4580	4.5x80	Ph1	165	55	24,50
4120 18 5100	4.5x100	Ph1	185	55	27,30
4120 18 5150	4.5x150	Ph1	235	60	32,65
4120 18 6100	6x100	Ph2	195	85	29,50
4120 18 6150	6x150	Ph2	245	95	35,35
4120 18 6200	6x200	Ph2	295	105	45,90
4120 18 8150	8x150	Ph3	255	150	56,00
4120 18 1200	10x200	Ph4	315	240	86,65

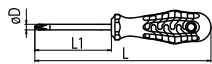
4120
Kraft Seri Süngüsü Uzun Yıldız Uçlu Tornavida
Screwdriver, Kraft, Phillips, Long

Krom vanadyum, Krom kaplı, Ucu siyah oksit, Selüloz asetat saplı
Chrom vanadium, Chrom plated and black tip, Cellulose acetate handle.

KOD CODE	ØDxL1 mm	+	L mm	g	TL/Ad.
4120 18 5300	4.5x300	Ph1	385	80	77,35
4120 18 6300	6x300	Ph2	395	125	80,00

4120
Kraft Seri Yıldız Uçlu Tornavida Takımı (6 parça)
Screwdriver, Kraft, Phillips, Set (6 Pcs)

KOD CODE	İÇERİK CONTENTS	g	TL/Ad.
4120 00 8106	3x60 - 4.5x80 4.5x100 - 4.5x150 6x100 - 6x150 Yıldız uçlu / Phillips	380	166,30

4100
Kraft Seri Tornavida Seti (7 parça)
Screwdriver Set, Kraft (7 Pcs)



KOD CODE	İÇERİK CONTENTS	g	TL/Ad.
4100 00 8107	3x80 - 4x80 - 4x100 5x125 - 6x150 Düz uçlu / Flat 4.5x80 - 6x100 Yıldız uçlu / Phillips	445	164,40

(*) İşaretili olan ürünler stoklarla sınırlıdır.
Limited with stocks.

4110

Kraft Seri Düz Uçlu Topaç Tornavida
Screwdriver, Kraft, Stubby, Flat

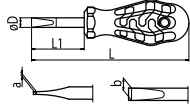
TS 59



Krom vanadyum, Krom kaplı, Ucu siyah oksit, Selüloz asetat saplı
Chrom vanadium, Chrom plated and black tip,
Cellulose acetate handle

KOD CODE	øDxL1 mm	-		L mm	g	□	TL/Ad.
		a mm	b mm				
★4110 17 0425	4x25	0.8	4	70	40	5	13,15
4110 17 5525	5.5x25	1	5.5	70	30	5	17,45
4110 17 5540	5.5x40	1	5.5	105	45	5	23,60
4110 17 6525	6.5x25	1.2	6.5	70	35	5	19,40
4110 17 6540	6.5x40	1.2	6.5	105	50	5	26,75
★4110 17 0825	8x25	1.2	8	70	40	5	18,40

4130

Kraft Seri Yıldız Uçlu Topaç Tornavida
Screwdriver, Kraft, Stubby, Phillips

TS 59 -5

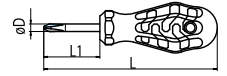

Krom vanadyum, Krom kaplı, Ucu siyah oksit, Selüloz asetat saplı
Chrom vanadium, Chrom plated and black tip,
Cellulose acetate handle

KOD CODE	øDxL1 mm	+	L mm	g	□	TL/Ad.
4130 18 4540	4.5x40	Ph1	105	40	5	23,50
4130 18 0625	6x25	Ph2	70	30	5	19,50
4130 18 0640	6x40	Ph2	105	50	5	26,40



4140

1000V İzoleli Elektrikçi Düz Uçlu Tornavida
Insulated Electrician Type Flat
Screwdriver 1000V

TS 59
TS ISO 2380-1
DIN ISO 2380-1
⚡ 1000 V
IEC 60900

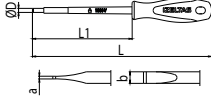

Krom vanadyum, Siyah oksit kaplı
Chrom vanadium, Black finish

KOD CODE	øDxL1 mm	⊖		L mm	g	□	TL/Ad.
		a mm	b mm				
4140 17 2575	2.5x75	0.4	2.5	150	25	10	19,40
4140 17 4100	4x100	0.8	4	185	40	10	22,80
4140 17 5512	5.5x125	1	5.5	220	70	10	30,05
4140 17 6515	6.5x150	1.2	6.5	245	90	10	33,60

4140

1000V İzoleli Elektrikçi Tornavida Seti (6 Parça)
Insulated Electrician Set (6 Pcs) Screwdriver 1000V



KOD CODE	İÇERİK CONTENTS	g	□	TL/Ad.
4140 00 9106	2.5x75 - 4x100	340	6	168,00
	⊖ 5.5x125 - 6.5x150			
	Düz uçlu / Flat			
	⊕ 4.5x80 - 6x100			
	Yıldız uçlu / Phillips			

4145

1000V İzoleli Elektrikçi Yıldız Uçlu Tornavida
Insulated Electrician Type Phillips
Screwdriver 1000V

TS 59
TS 59-5ISO 8764
DIN ISO 8764
⚡ 1000 V
IEC 60900



Krom vanadyum, Siyah oksit kaplı
Chrom vanadium, Black finish

KOD CODE	øDxL1 mm	⊕	L mm	g	□	TL/Ad.
4145 18 0360	3x60	Ph0	135	25	10	20,20
4145 18 4580	4.5x80	Ph1	165	45	10	28,55
4145 18 6100	6x100	Ph2	195	70	10	33,60

4101

Süngüsü İzoleli Düz Uçlu Tornavida
Screwdriver, Electrician Blade,
Insulated, Flat

TS 59
⚡ 1000 V
IEC 60900

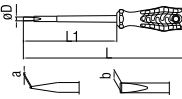

Krom vanadyum, Siyah oksit kaplı
Chrom vanadium, Black finish

KOD CODE	øDxL1 mm	⊖		L mm	g	□	TL/Ad.
		a mm	b mm				
★4101 17 2575	2.5x75	0.4	2.5	150	25	10	16,40
★4101 17 4100	4x100	0.8	4	185	40	10	20,75
★4101 17 5512	5.5x125	1	5.5	220	70	10	28,70
★4101 17 6515	6.5x150	1.2	6.5	245	90	10	31,20

4121

Süngüsü İzoleli Yıldız Uçlu Tornavida
Screwdriver, Electrician Blade,
Insulated, Phillips

TS 59
⚡ 1000 V
IEC 60900

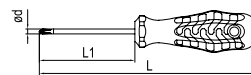

Krom vanadyum, Siyah oksit kaplı
Chrom vanadium, Black finish

KOD CODE	øDxL1 mm	⊕	L mm	g	□	TL/Ad.
★4121 18 0360	3x60	Ph0	135	25	10	19,45
★4121 18 4580	4.5x80	Ph1	165	45	10	26,00
★4121 18 6100	6x100	Ph2	195	70	10	31,60

Opak Seri Düz Uçlu Tornavida
Screwdriver, Opak, Flat

TS ISO 2380-1
DIN ISO 2380-1



Krom vanadyum, Krom kaplı, Ucu siyah oksit, PP saplı
Chrome vanadium, Chrom plated and black tip, PP handle

KOD CODE	øDxL1 mm	⊖		L mm	g	□	TL/Ad.
		a mm	b mm				
4300 17 0380	3x80	0.5	3	155	25	10	14,10
4300 17 0480	4x80	0.8	4	165	35	10	14,60
4300 17 4100	4x100	0.8	4	185	40	10	17,45
4300 17 5100	5x100	1.0	5.5	195	60	10	21,05
4300 17 5125	5x125	1.0	5.5	220	60	10	24,50
4300 17 6100	6x100	1.2	6.5	195	65	10	21,90
4300 17 6125	6x125	1.2	6.5	220	70	10	25,00
4300 17 6150	6x150	1.2	6.5	245	80	10	27,35
4300 17 7125	7x125	1.2	8	230	95	10	28,00
4300 17 7150	7x150	1.2	8	255	105	10	32,15
4300 17 8175	8x175	1.6	10	280	130	10	39,05
4300 17 9200	9x200	2.0	12	305	165	10	51,55

Opak Seri Yıldız Uçlu Tornavida
Screwdriver, Opak, Phillips

TS 59 - 5 ISO 8764-1
DIN ISO 8764



Krom vanadyum, Krom kaplı, Ucu siyah oksit, PP saplı
Chrome vanadium, Chrom plated and black tip, PP handle

KOD CODE	øDxL1 mm	⊕	L mm	g	□	TL/Ad.
4320 18 4580	4.5x80	Ph1	165	40	10	22,25
4320 18 6100	6x100	Ph2	195	70	10	26,90
4320 18 8150	8x150	Ph3	255	140	10	51,05

Opak Seri Tornavida Seti (7 Parça)
Screwdriver Set, Opak (7 Pcs)



KOD CODE	İÇERİK CONTENTS	g	□	TL/Ad.
4300 00 8107	3x80 - 4x80 - 4x100	520	7	147,15
	⊖ 5x125 - 6x150			
	⊕ 4.5x80 - 6x100			
	Yıldız uçlu / Phillips			

Opak Seri Pozidriv Yıldız Uçlu Tornavida
Screwdriver, Opak, Pozidriv

DIN ISO 8764



Krom vanadyum, Krom kaplı, Ucu siyah oksit, PP saplı
Chrome vanadium, Chrom plated and black tip, PP handle

KOD CODE	øDxL1 mm	⊕	L mm	g	□	TL/Ad.
4325 18 0360	3x60	Pz0	135	25	10	17,00
4325 18 4580	4.5x80	Pz1	165	40	10	24,50
4325 18 6100	6x100	Pz2	195	70	10	29,50
4325 18 8150	8x150	Pz3	255	140	10	56,00

4350

Ergonomik Seri Düz Uçlu Tornavida Screwdriver, Ergonomic, Flat

TS ISO 2380-1
DIN ISO 2380-1

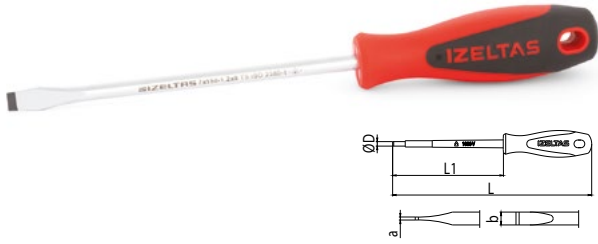

Krom vanadyum, Krom kaplı, Ucu siyah oksit, İki komponent saplı
Chrome vanadium, Chrom plated and black tip,
Two component handle.

KOD CODE	øDxL1 mm	Ø		L mm	g	TL/Ad.	
		a mm	b mm				
4350 17 0380	3x80	0.5	3	155	25	10	17,45
4350 17 0480	4x80	0.8	4	165	40	10	18,30
4350 17 4100	4x100	0.8	4	185	40	10	20,85
4350 17 5100	5x100	1.0	5.5	195	60	10	24,00
4350 17 5125	5x125	1.0	5.5	220	65	10	27,70
4350 17 6100	6x100	1.2	6.5	195	70	10	24,85
4350 17 6125	6x125	1.2	6.5	220	75	10	28,45
4350 17 6150	6x150	1.2	6.5	245	80	10	31,20
4350 17 7125	7x125	1.2	8	230	100	10	31,80
4350 17 7150	7x150	1.2	8	255	110	10	36,55
4350 17 8175	8x175	1.6	10	280	140	10	44,35
4350 17 9200	9x200	2	12	305	180	10	56,55

4370

Ergonomik Seri Yıldız Uçlu Tornavida Screwdriver, Ergonomic, Phillips

TS 59 - 5 ISO 8764-1
DIN ISO 8764-1



Krom vanadyum, Krom kaplı, Ucu siyah oksit, İki komponent saplı
Chrome vanadium, Chrom plated and black tip,
Two component handle.

KOD CODE	øDxL1 mm	+	L mm	g	TL/Ad.	
4370 18 0360	3x60	Ph0	135	25	10	17,75
4370 18 4580	4.5x80	Ph1	165	45	10	25,35
★4370 18 5100	4.5x100	Ph1	185	50	10	24,25
★4370 18 5150	4.5x150	Ph1	235	70	10	27,50
4370 18 6100	6x100	Ph2	195	70	10	30,75
★4370 18 6150	6x150	Ph2	245	150	10	32,20
4370 18 8150	8x150	Ph3	255	130	10	57,90

4350

Ergonomik Seri Tornavida Seti (7 Parça) Screwdriver Set, Ergonomic (7 Pcs.)



KOD CODE	İÇERİK CONTENTS	g	TL/Ad.
4350 00 8107	3x80 - 4x80 - 4x100	370	7
	5x125 - 6x150		
	Düz uçlu / Flat		
	4.5x80 - 6x100		
	Yıldız uçlu / Phillips		171,60



(★) İşaretili olan ürünler stoklarla sınırlıdır.
Limited with stocks.

Değişken Uçlu Tornavida Screwdriver - Reversible

TSEK



Krom vanadyum, Krom kaplı, Selüloz asetat saplı
Chrom vanadium, Chrom plated, Cellulose acetate handle

KOD CODE	ØDxL1 mm	⊖ axb mm	⊕	L mm	g	TL/Ad.	
4240 17 0680	6x80	1.2x6	Ph2	175	80	10	30,85

Değişken Uçlu Tornavida Takımı Screwdriver Set - Reversible

TSEK



KOD CODE	ØDxL1 mm	⊖ axb mm	⊕	L mm	g	TL/Ad.	
4240 00 7102	6x80	1.2x6	Ph2	175	105	1	51,15
	4.5x80	0.65x4.5	Ph1				

Elektronikçi Tip (Klemens) Düz Uçlu Tornavida Electronic Screwdriver, Flat



Krom vanadyum, Krom kaplı, Ucu siyah oksit, PP saplı
Chrome vanadium, Chrom plated and black tip, PP handle

KOD CODE	ØDxL1 mm	a mm	b mm	L mm	g	TL/Ad.	
4500 17 2560	2.5x60	0.4	2.5	140	15	10	13,70
4500 17 2580	2.5x80	0.4	2.5	160	15	10	14,35
4500 17 0380	3x80	0.5	3	160	15	10	15,20
4500 17 3100	3x100	0.5	3	180	20	10	18,55
4500 17 3125	3x125	0.5	3	205	20	10	24,50
4500 17 3510	3.5x100	0.6	3.5	180	20	10	19,15
4500 17 0480	4x80	0.8	4	160	20	10	15,60
4500 17 4100	4x100	0.8	4	180	20	10	19,15
4500 17 4125	4x125	0.8	4	205	25	10	25,75
4500 17 4150	4x150	0.8	4	230	25	10	28,05

Elektronikçi Tip (Klemens) Yıldız Uçlu Tornavida Electronic Screwdriver, Phillips



Krom vanadyum, Krom kaplı, Ucu siyah oksit, PP saplı
Chrome vanadium, Chrom plated and black tip, PP handle

KOD CODE	ØDxL1 mm	⊕	L mm	g	TL/Ad.	
4520 18 0360	3x60	Ph0	140	15	10	16,05
4520 18 0480	4x80	Ph0	160	20	10	23,05
4520 18 4150	4x150	Ph0	230	25	10	30,80

Elektronikçi Tip (Klemens) Tornavida Seti (6 Parça) Electronic Screwdriver Set (6 Pcs)



KOD CODE	İÇERİK CONTENTS	g	TL/Ad.	
4500 00 8106	3x80 - 3x100 3x125 - 4x150 Düz uçlu / Flat 3x60 - 4x80 Yıldız uçlu / Phillips	115	6	125,40

4540

Klips Sökme Tornavidası
Hupcap and Clip Remover

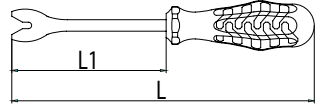

Krom vanadyum, Krom kaplı, PP Saplı
Chrom vanadium, Chrom plated, PP insulated

KOD CODE	L mm	L1	g	TL/Ad.
4540 19 0190	290	180	160	10 57,20

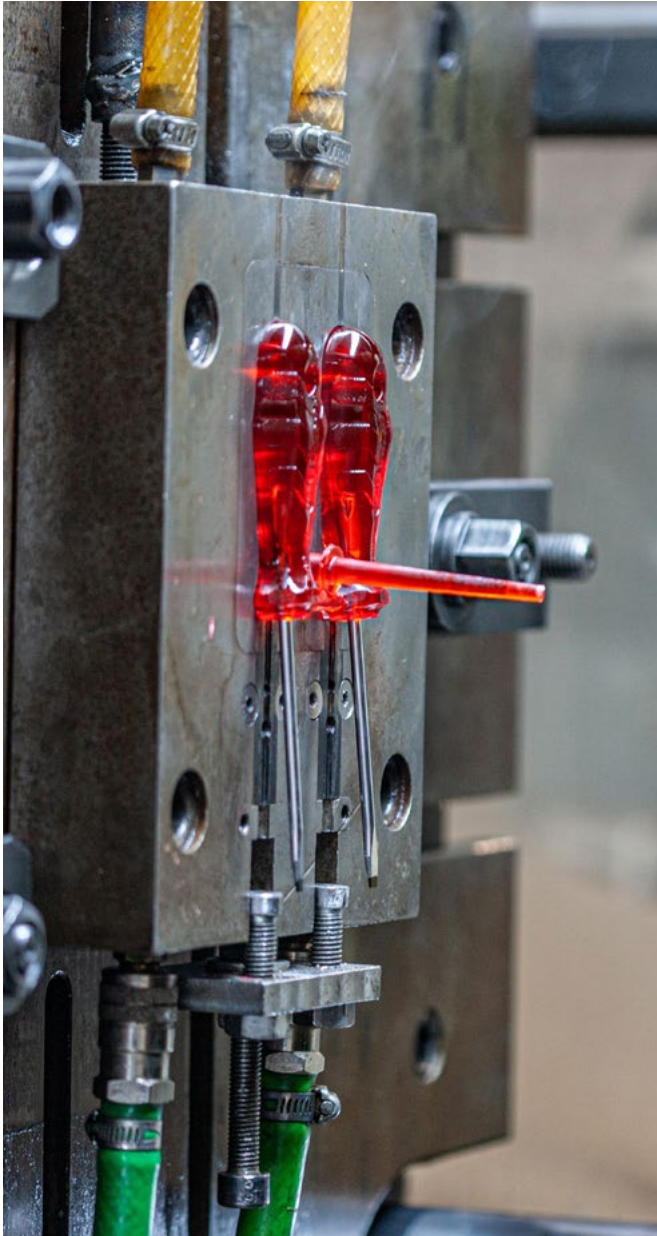

4530

Elektronikçi Tip (Klemens) Torx® Uçlu Tornavida
Electronic Screwdriver, Torx®

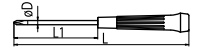

Krom vanadyum, Krom kaplı, Ucu siyah oksit, PP saplı
Chrom vanadium, Chrom plated and black tip, PP handle

KOD CODE	ØDxL1 mm	☆	L mm	g	TL/Ad.
4530 17 0560	2.5x60	T5	145	15	10 18,55
4530 17 0660	2.5x60	T6	145	15	10 18,55
4530 17 0760	3x60	T7	145	15	10 19,20
4530 17 0860	3x60	T8	145	20	10 19,20
4530 17 0960	3x60	T9	145	20	10 19,20
4530 17 1060	3.5x60	T10	145	20	10 19,20

4530

Elektronikçi Tip (Klemens) Torx® Uçlu Tornavida Takımı (6 Parça)
Electronic Screwdriver Set Torx (6 Pcs)



KOD CODE	İÇERİK CONTENTS	g	TL/Ad.
4530 00 1006	T5 - T6 - T7 - T8 - T9 - T10	115	6 113,90

(☆) İşaretili olan ürünler stoklarla sınırlıdır.
Limited with stocks.

T Tipi Lokma Uçlu Tornavida (mm)
Nut Spinner With T-Handle (mm)

Krom vanadyum, Krom kaplı, PP Saplı
Chrom vanadium, Chrom plated, PP insulated

KOD CODE	mm	L mm	L1 mm	g	TL/Ad.	
4765 19 0040	4	185	135	75	10	36,60
4765 19 0050	5	185	135	75	10	36,60
4765 19 0055	5.5	185	135	75	10	36,60
4765 19 0060	6	185	135	75	10	36,60
4765 19 0070	7	185	135	90	10	39,05
4765 19 0080	8	185	135	95	10	39,05
4765 19 0090	9	185	135	100	10	43,30
4765 19 0100	10	185	135	100	10	43,30
4765 19 0110	11	185	135	110	10	47,90
4765 19 0120	12	185	135	110	10	49,45
4765 19 0130	13	185	135	115	10	51,70
4765 19 0140	14	185	135	115	10	60,15

Lokma Uçlu Tornavida (mm)
Nut Spinner (mm)

DIN 3125



Krom vanadyum, Krom kaplı, PP Saplı
Chrom vanadium, Chrom plated, PP insulated

KOD CODE	mm	L mm	L1 mm	g	TL/Ad.	
4770 19 0040	4	220	125	80	10	43,95
4770 19 0050	5	220	125	80	10	43,95
4770 19 0055	5.5	220	125	80	10	43,95
4770 19 0060	6	220	125	80	10	43,95
4770 19 0070	7	230	125	100	10	47,20
4770 19 0080	8	230	125	110	10	47,20
4770 19 0090	9	230	125	115	10	50,90
4770 19 0100	10	230	125	115	10	50,90
4770 19 0110	11	230	125	130	10	55,60
4770 19 0120	12	230	125	135	10	59,65
4770 19 0130	13	230	125	140	10	64,25
4770 19 0140	14	230	125	140	10	71,05

Süngüsü İzoleli Lokma Uçlu Tornavida
Nut Spinner, Electrician Blade Insulated

DIN 3125



Krom vanadyum, PP saplı
Chrome vanadium, PP handle

KOD CODE	mm	L mm	L1 mm	g	TL/Ad.	
★4772 19 0040	4	220	125	90	10	54,30
★4772 19 0050	5	220	125	90	10	54,30
★4772 19 0060	6	220	125	90	10	54,30
★4772 19 0070	7	230	125	110	10	58,30
★4772 19 0080	8	230	125	120	10	58,30
★4772 19 0090	9	230	125	125	10	62,95
★4772 19 0100	10	230	125	125	10	62,95
★4772 19 0110	11	230	125	140	10	68,75
★4772 19 0120	12	230	125	145	10	73,90
★4772 19 0130	13	230	125	150	10	75,00
★4772 19 0140	14	230	125	150	10	87,90

Lokma Uçlu Tornavida Takımı (8 Parça, mm)
Nut Spinner Set (8 Pcs, mm)

KOD CODE	İÇERİK CONTENTS	g	TL/Ad.
4770 00 8108	6 - 7 - 8 - 9 - 10 11 - 12 - 13	2145	8 419,65

4773

1000V Süngüsü İzoleli Lokma Uçlu Tornavida
Nut Spinner, Electrician Blade Insulated 1000V

DIN 3125

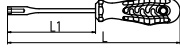

Krom vanadyum, İki Komponent Saplı
Chrome vanadium, Two Component Insulated



KOD CODE	mm	L mm	L1 mm	g		TL/Ad.
4773 19 0040	4	220	125	90	10	62,35
4773 19 0050	5	220	125	90	10	62,35
4773 19 0055	5.5	220	125	90	10	62,35
4773 19 0060	6	220	125	90	10	62,35
4773 19 0070	7	230	125	110	10	66,85
4773 19 0080	8	230	125	120	10	66,85
4773 19 0090	9	230	125	125	10	72,20
4773 19 0100	10	230	125	125	10	72,20
4773 19 0110	11	230	125	140	10	78,80
4773 19 0120	12	230	125	145	10	84,55
4773 19 0130	13	230	125	150	10	91,10
4773 19 0140	14	230	125	150	10	100,75

4773

1000V Süngüsü İzoleli Lokma Uçlu Tornavida Takımı (8 Parça)
Nut Spinner, Electrician Blade Insulated Set (8 Pcs)
1000V



KOD CODE	İÇERİK CONTENTS	g		TL/Ad.
4773 00 8108	6 - 7 - 8 - 9 - 10 - 11 - 12 - 13	2225	8	594,90

4775

Torx® Uçlu Tornavida
Torx® Screwdriver

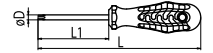

Krom vanadyum, Krom kaplı, Ucu siyah oksit, PP saplı
Chrome vanadium, Chrom plated and blackened, PP handle

KOD CODE	ØDxL1 mm	★	L mm	g		TL/Ad.
4775 18 0010	4x80	T10	165	35	10	23,80
4775 18 0015	4x80	T15	165	35	10	23,80
4775 18 0020	4x100	T20	185	40	10	26,40
4775 18 0025	4.5x100	T25	185	40	10	30,60
4775 18 0027	5x125	T27	220	60	10	33,80
4775 18 0030	6x125	T30	220	70	10	35,85
4775 18 0040	7x125	T40	230	100	10	44,55
4775 18 0045	8x125	T45	230	120	10	50,35

4775

Torx® Uçlu Tornavida Takımı (7 Parça)
Torx® Screwdriver Set (7 Pcs)



KOD CODE	İÇERİK CONTENTS	g		TL/Ad.
4775 00 8107	T10 - T15 - T20 - T25 - T27 - T30 - T40	380	7	218,80

4776

Delikli Torx® Uçlu Tornavida
Torx® Screwdriver / Tamper Resistance

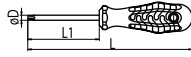

Krom vanadyum, Krom kaplı, Ucu siyah oksit, PP saplı
Chrome vanadium, Chrom plated and blackened, PP handle

KOD CODE	ØDxL1 mm	☆	L mm	g	□	TL/Ad.
4776 18 0009	4x60	TR9	145	35	10	28,75
4776 18 0010	4x80	TR10	165	35	10	29,70
4776 18 0015	4x80	TR15	165	40	10	29,70
4776 18 0020	4x100	TR20	185	40	10	33,15
4776 18 0025	4.5x100	TR25	185	45	10	38,25
4776 18 0027	5x125	TR27	220	60	10	42,20
4776 18 0030	6x125	TR30	220	70	10	44,85
4776 18 0040	7x125	TR40	230	100	10	55,60

4776

Delikli Torx® Uçlu Tornavida Takımı (7 Parça)
Torx® Screwdriver / Tamper Resistance Set (7 Pcs)



KOD CODE	İÇERİK CONTENTS	g	□	TL/Ad.
4776 00 8107	TR10 - TR15 - TR20 - TR25 - TR27 TR30 - TR40	380	7	273,45

4780

Manyetik Bits Tutucu Tornavida (Uzun)
Screwdriver, Magnetic Bit Holder (Long)



KOD CODE	mm	L mm	L1 mm	g	□	TL/Ad.
4780 19 6120	6.3	230	120	105	10	53,85

4783

1000V Süngüsü İzoleli Manyetik Bits Tutucu Tornavida
Screwdriver, Magnetic Bit Holder Insulated
1000V

⚡ 1000 V
IEC 60900



KOD CODE	mm	L mm	L1 mm	g	□	TL/Ad.
4783 19 6120	6.3	230	120	115	10	70,10

4785

Manyetik Bits Tutucu Tornavida (Kısa)
Screwdriver, Magnetic Bit Holder, (Short)



KOD CODE	mm	L mm	L1 mm	g	□	TL/Ad.
4785 19 6330	6.3	130	30	60	10	30,85

4790

Üniversal Bits Adaptörü (Manyetik)
Screwdriver Universal Bit Holder (Magnetic)



KOD CODE	mm	mm	L mm	g	□	TL/Ad.
4790 26 6360	6.3	6.3	60	25	10	23,65

4795

T Tipi Manyetik Bits Tutucu Tornavida Magnetic Bit Holder With T-Handle



KOD CODE	mm	L mm	L1 mm	g		TL/Ad.
4795 19 0010	6.3	180	130	60	10	52,45

4788

Manyetik Bits Tutucu Tornavida, Flexible Screwdriver, Magnetic Bit Holder, Flexible



KOD CODE	mm	L mm	L1 mm	g		TL/Ad.
4788 19 6160	6.3	285	175	130	10	117,60

4805

Bits Uç Lokma Adaptörü (Makine Kullanımına Uygun) Socket Adapter

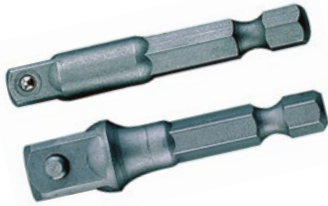

KOD CODE		L mm	g		TL/Ad.
4805 20 5010	1/4"M - 1/4"M	50	20	10	9,70
4805 20 5011	1/4"M - 1/2"M	50	25	10	19,75

4815

Değişken Bits Uçlu Tornavida Set (7 parça) Screwdriver - Interchangeable Bits Set (7 pcs)



KOD CODE	İÇERİK CONTENTS	g		TL/Ad.
4815 00 6107	100mm Sap Ph1x4.5 - Ph2x5.5 - Ph3x7 Pz1x4.5 - Pz2x5.5 - Pz3x7	140	7	65,25

4800

6'lı Bits Set Bit Set (6 Pcs)



KOD CODE	İÇERİK CONTENTS	g		TL/Ad.
4800 00 8106	0.6x4.5 - 0.8x5.5	50	6	23,10
	Ph1 - Ph2 - Ph3			
	T27			

4800

10'lu Bits Set Bit Set (10 Pcs)



KOD CODE	İÇERİK CONTENTS	g		TL/Ad.
4800 00 8110	0.6x4.5 - 0.8x5.5 1.2x6.5	55	10	42,80
	Ph1 - Ph2 - Ph3			
	T25 - T27 - T30 - T40			

4800

31'li Bits Set (Plastik Kutulu) Bit Set In Plastic Case (31 Pcs)



KOD CODE	İÇERİK CONTENTS	g		TL/Ad.
4800 00 8131	0.6x4.5 - 0.8x5.5	385	6 - 6	139,15
	1.2x6.5			
	Ph1			
	Ph2 - Ph3			
	T27			
	T25 - T30 - T40			
6.3 x 60 Adaptör	1			

(*) İşaretili olan ürünler stoklarla sınırlıdır.
Limited with stocks.

Düz Bits Uçlar

Bits Flat

25mm-50mm-75mm-100mm-150mm



Krom vanadyum
Chrom vanadium

KOD CODE	⊖	L mm	g	TL/Ad.	
4810 20 0645	0.6x4.5	25	5	10	3,35
4810 20 0855	0.8x5.5	25	5	10	3,35
4810 20 1265	1.2x6.5	25	5	10	3,35
4810 20 5645	0.6x4.5	50	10	10	5,30
4810 20 5855	0.8x5.5	50	10	10	5,30
4810 20 5265	1.2x6.5	50	10	10	5,30
4860 20 0745	0.6x4.5	75	11	10	8,10
4860 20 0755	0.8x5.5	75	13	10	8,10
4860 20 0765	1.2x6.5	75	15	10	8,10
4860 20 1045	0.6x4.5	100	14	10	12,10
4860 20 1055	0.8x5.5	100	17	10	12,10
4860 20 1065	1.2x6.5	100	18	10	12,10
4860 20 1545	0.6x4.5	150	21	10	17,35
4860 20 1555	0.8x5.5	150	26	10	17,35
4860 20 1565	1.2x6.5	150	28	10	17,35

Yıldız Bits Uçlar

Bits Phillips

25mm-50mm-75mm-100mm-150mm



Krom vanadyum
Chrom vanadium

KOD CODE	⊕	L mm	g	TL/Ad.	
4820 21 0001	Ph1	25	5	10	3,65
4820 21 0002	Ph2	25	5	10	3,65
4820 21 0003	Ph3	25	5	10	3,65
4820 21 0011	Ph1	50	10	10	5,45
4820 21 0012	Ph2	50	10	10	5,45
4820 21 0013	Ph3	50	10	10	5,45
4870 21 0701	Ph1	75	17	10	8,20
4870 21 0702	Ph2	75	18	10	8,20
4870 21 0703	Ph3	75	18	10	8,20
4870 21 1001	Ph1	100	20	10	12,55
4870 21 1002	Ph2	100	24	10	12,55
4870 21 1003	Ph3	100	24	10	12,55
4870 21 1501	Ph1	150	23	10	17,80
4870 21 1502	Ph2	150	33	10	17,80
4870 21 1503	Ph3	150	33	10	17,80

Düz Bits Takımı (25 mm)

Flat Bit Set (25 mm)



KOD CODE	⊖	g	TL/Ad.	
4810 00 0645	0.6x4.5	45	10	33,50
4810 00 0855	0.8x5.5	50	10	33,50
4810 00 1265	1.2x6.5	55	10	33,50

Yıldız Bits Takımı (25 mm)

Phillips Bit Set (25 mm)



KOD CODE	⊕	g	TL/Ad.	
4820 00 0001	Ph1	50	10	36,50
4820 00 0002	Ph2	50	10	36,50
4820 00 0003	Ph3	55	10	36,50

4825-4880

Pozidriv Bits Uçlar Bits Pozidriv

25mm-50mm-75mm-100mm-150mm



Krom vanadyum
Chrom vanadium

KOD CODE	+	L mm	g	TL/Ad.
4825 21 0001	Pz1	25	5	3,95
4825 21 0002	Pz2	25	5	3,95
4825 21 0003	Pz3	25	5	3,95
4825 21 0011	Pz1	50	10	5,75
4825 21 0012	Pz2	50	10	5,75
4825 21 0013	Pz3	50	10	5,75
4880 21 0701	Pz1	75	17	8,35
4880 21 0702	Pz2	75	18	8,35
4880 21 0703	Pz3	75	18	8,35
4880 21 1001	Pz1	100	20	12,65
4880 21 1002	Pz2	100	24	12,65
4880 21 1003	Pz3	100	24	12,65
4880 21 1501	Pz1	150	23	18,20
4880 21 1502	Pz2	150	33	18,20
4880 21 1503	Pz3	150	33	18,20

4825

Pozidriv Bits Takımı (25 mm) Pozidriv Bit Set (25 mm)



KOD CODE	+	g	TL/Ad.
4825 00 0001	Pz1	50	39,50
4825 00 0002	Pz2	55	39,50
4825 00 0003	Pz3	55	39,50

4830-4885

Torx® Bits Uçlar Bits Torx®

25mm-50mm-75mm-100mm-150mm



Krom vanadyum
Chrom vanadium

KOD CODE	T	L mm	g	TL/Ad.
4830 21 0025	T25	25	5	5,45
4830 21 0027	T27	25	5	5,45
4830 21 0030	T30	25	5	5,45
4830 21 0040	T40	25	5	5,45
4830 21 0125	T25	50	10	6,85
4830 21 0127	T27	50	10	6,85
4830 21 0130	T30	50	10	6,85
4830 21 0140	T40	50	10	6,85
4885 21 0725	T25	75	12	8,90
4885 21 0727	T27	75	15	8,90
4885 21 0730	T30	75	15	8,90
4885 21 0740	T40	75	17	8,90
4885 21 1025	T25	100	15	12,90
4885 21 1027	T27	100	20	12,90
4885 21 1030	T30	100	20	12,90
4885 21 1040	T40	100	23	12,90
4885 21 1525	T25	150	20	18,50
4885 21 1527	T27	150	25	18,50
4885 21 1530	T30	150	25	18,50
4885 21 1540	T40	150	33	18,50

4830

Torx® Bits Takımı (25 mm) Torx® Bit Set (25 mm)



KOD CODE	T	g	TL/Ad.
4830 00 0025	T25	50	54,50
4830 00 0027	T27	50	54,50
4830 00 0030	T30	55	54,50
4830 00 0040	T40	60	54,50

4784

1/4"Avuç İçi Bits Tutucu
Palm Ratchet Bit Holder



KOD CODE	∅	L mm	g	TL/Ad.
4784 19 6346	46	26,5	100	5 109,30

4850

100mm Uzun Bits Uç Takımı (13 Parça)
Bit Set, Long Type 100 mm (13 Pcs)



100mm

KOD CODE	İÇERİK CONTENTS	g	TL/Ad.
4850 00 1013	Düz Uçlar Flat Bits 0.6x4.5 - 0.8x 5.5 1.2x6.5	263	13 163,50
	Yıldız Uçlar Phillips Bits Ph1 - Ph2 - Ph3		
	Pozidriv Uçlar Pozidriv Bits Pz1 - Pz2 - Pz3		
	Torx® Uçlar Torx® Bits T25 - T27 -T30 - T40		

4850

75mm Uzun Bits Uç Takımı (13 Parça)
Bit Set, Long Type 75 mm (13 Pcs)



75mm

KOD CODE	İÇERİK CONTENTS	g	TL/Ad.
4850 00 0713	Düz Uçlar Flat Bits 0.6x4.5 - 0.8x 5.5 1.2x6.5	204	13 109,55
	Yıldız Uçlar Phillips Bits Ph1 - Ph2 - Ph3		
	Pozidriv Uçlar Pozidriv Bits Pz1 - Pz2 - Pz3		
	Torx® Uçlar Torx® Bits T25 - T27 T30 - T40		

4850

150mm Uzun Bits Uç Takımı (13 Parça)
Bit Set, Long Type 150 mm (13 Pcs)



150mm

KOD CODE	İÇERİK CONTENTS	g	TL/Ad.
4850 00 1513	Düz Uçlar Flat Bits 0.6x4.5 - 0.8x 5.5 1.2x6.5	356	13 234,05
	Yıldız Uçlar Phillips Bits Ph1 - Ph2 - Ph3		
	Pozidriv Uçlar Pozidriv Bits Pz1 - Pz2 - Pz3		
	Torx® Uçlar Torx® Bits T25 - T27 - T30 - T40		

4900

Allen Anahtar Altı Köşe (mm) Hex Key Wrench (mm)

TS ISO 2936
DIN ISO 2936

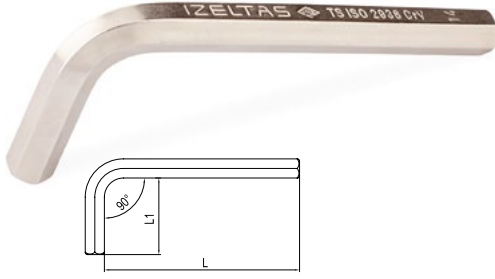

Krom Vanadyum, Nikel Kaplı
Chrom Vanadium, Nickel Plated

KOD CODE	mm	L mm	L1 mm	g	TL/Ad.	
4900 22 0015	1.5	45	14	1.5	10	2,00
4900 22 0020	2	50	16	2	10	2,35
4900 22 0025	2.5	56	18	4	10	2,90
4900 22 0030	3	63	20	6	10	3,20
4900 22 0035	3.5	66	22	8	10	3,95
4900 22 0040	4	70	25	10	10	4,05
4900 22 0050	5	80	28	20	10	4,70
4900 22 0060	6	90	32	30	10	6,25
4900 22 0070	7	95	34	40	10	9,20
4900 22 0080	8	100	36	55	10	9,70
4900 22 0090	9	105	38	75	10	11,95
4900 22 0100	10	112	40	100	10	14,75
4900 22 0120	12	125	45	160	10	18,90
4900 22 0140	14	140	56	250	5	32,30
4900 22 0160	16	152	60	375	5	59,70
4900 22 0170	17	160	63	425	5	64,35
4900 22 0190	19	180	70	610	5	79,60
4900 22 0220	22	200	80	940	5	124,05
4900 22 0240	24	224	90	1250	5	167,45

4900

Allen Anahtar Takım Altı Köşe (mm) Hex Key Wrench Set (mm)



KOD CODE	İÇERİK CONTENTS	g	TL/Ad.	
4900 00 3110	2 - 2.5 - 3 - 4 - 5 - 6 7 - 8 - 9 - 10	400	10	69,05
4900 00 3112	2 - 2.5 - 3 - 3.5 - 4 - 5 6 - 7 - 8 - 9 - 10 - 12	565	12	91,90

4901

Allen Anahtar Altı Köşe (SAE) Hex Key Wrench (SAE)

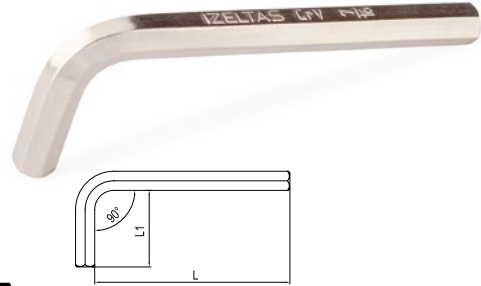

Krom Vanadyum, Nikel Kaplı
Chrom Vanadium, Nickel Plated

KOD CODE	inch	L mm	L1 mm	g	TL/Ad.	
4901 22 1984	5/64"	50	16	2	10	3,85
4901 22 2381	3/32"	54	18	4	10	4,20
4901 22 3125	1/8"	58	20	5	10	5,10
4901 22 3968	5/32"	62	22	10	10	6,25
4901 22 4762	3/16"	68	24	15	10	6,40
4901 22 5556	7/32"	74	26	25	10	8,60
4901 22 6350	1/4"	82	28	35	10	10,50
4901 22 7937	5/16"	94	32	55	10	13,05
4901 22 9825	3/8"	106	38	90	10	18,00
4901 22 1111	7/16"	118	42	130	10	24,25
4901 22 1270	1/2"	132	46	190	10	30,60
4901 22 1428	9/16"	144	52	265	10	40,60
4901 22 1587	5/8"	156	58	365	10	69,35
4901 22 1905	3/4"	176	66	600	5	97,10

4901

Allen Anahtar Takım Altı Köşe (SAE) Hex Key Wrench Set (SAE)



KOD CODE	İÇERİK CONTENTS	g	TL/Ad.	
4901 00 3110	5/64" - 3/32" - 1/8" - 5/32" 3/16" - 7/32" - 1/4" - 5/16" 3/8" - 7/16"	405	10	100,20
4901 00 3112	5/64" - 3/32" - 1/8" - 5/32" 3/16" - 7/32" - 1/4" - 5/16" 3/8" - 7/16" - 1/2" - 9/16"	855	12	175,40

4903

Allen Anahtar Altı Köşe Uzun Boy (mm)
Hex Key Wrench Long Pattern (mm)

TS ISO 2936
DIN ISO 2936



Krom Vanadyum, Nikel Kaplı
Chrom Vanadium, Nickel Plated

KOD CODE	mm	L mm	L1 mm	g	TL/ Ad.	
4903 22 0020	2	100	16	3	10	4,20
4903 22 0025	2.5	112	18	5	10	4,95
4903 22 0030	3	126	20	10	10	5,65
4903 22 0035	3.5	136.5	22	15	10	6,95
4903 22 0040	4	140	25	20	10	7,10
4903 22 0050	5	160	28	30	10	7,45
4903 22 0060	6	180	32	50	10	12,10
4903 22 0070	7	190	34	80	10	18,00
4903 22 0080	8	200	36	100	10	18,90
4903 22 0090	9	210	38	145	10	23,25
4903 22 0100	10	224	40	180	10	28,85
4903 22 0120	12	250	45	285	10	36,55
4903 22 0140	14	280	56	460	5	63,05
4903 22 0160	16	290	60	625	5	102,05
4903 22 0170	17	320	63	750	5	111,15
4903 22 0190	19	360	70	1100	5	164,70

4903

Allen Anahtar Takım Altı Köşe Uzun Boy (mm)
Hex Key Wrench Set Long Pattern (mm)

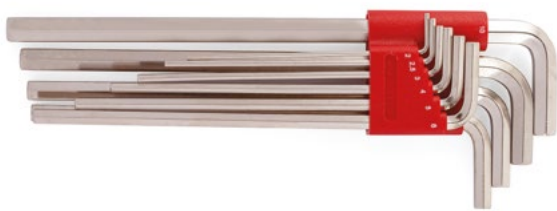

KOD CODE	İÇERİK CONTENTS	g	TL/Ad.	
4903 00 3110	2 - 2.5 - 3 - 4 - 5 - 6 7 - 8 - 9 - 10	660	10	130,45
4903 00 3112	2 - 2.5 - 3 - 3.5 - 4 - 5 6 - 7 - 8 - 9 - 10 - 12	940	12	173,95

4905

Yuvarlak Başlı Allen Anahtar (mm)
Hex Key Wrench Ballpoint (mm)



Krom Vanadyum, Nikel Kaplı
Chrom Vanadium, Nickel Plated

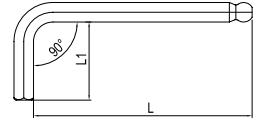

KOD CODE	mm	L mm	L1 mm	g	TL/ Ad.	
4905 22 0020	2	50	16	3	10	4,75
4905 22 0025	2.5	56	18	4	10	5,70
4905 22 0030	3	63	20	5	10	6,50
4905 22 0040	4	70	25	10	10	8,10
4905 22 0050	5	80	28	20	10	8,50
4905 22 0060	6	90	32	30	10	12,80
4905 22 0080	8	100	36	55	10	19,70
4905 22 0100	10	112	40	100	10	30,25

4905

Yuvarlak Başlı Allen Anahtar Takımı (8 Parça, mm)
Hex Key Wrench Ballpoint Set (8 Pcs, mm)



KOD CODE	İÇERİK CONTENTS	g	TL/Ad.	
4905 00 7108	2 - 2.5 - 3 - 4 5 - 6 - 8 - 10	275	8	96,30

4906

Yuvarlak Başlı Allen Anahtar Uzun Boy (mm)
Hex Key Wrench Ballpoint Long Pattern (mm)

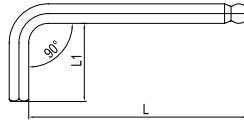

Krom Vanadyum, Nikel Kaplı
Chrom Vanadium, Nickel Plated

KOD CODE	mm	L mm	L1 mm	g	TL/Ad.
4906 22 0015	1.5	79	12	1.5	6,30
4906 22 0020	2	84	16	3	8,45
4906 22 0025	2.5	89	16	5	9,15
4906 22 0030	3	99	18	7	9,95
4906 22 0040	4	109	23	13	11,30
4906 22 0050	5	125	26	25	14,25
4906 22 0060	6	150	28	42	16,35
4906 22 0080	8	167	33	85	24,25
4906 22 0100	10	190	37	150	34,85

4910

Torx® Allen Anahtar
Torx® Key Wrench

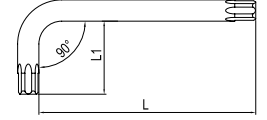

Krom Vanadyum, Nikel Kaplı
Chrom Vanadium, Nickel Plated

KOD CODE	☆	L mm	L1 mm	g	TL/Ad.
4910 22 0006	T6	42	16	2	10 17,35
4910 22 0007	T7	48	16	2	10 17,35
4910 22 0008	T8	48	16	3	10 17,35
4910 22 0009	T9	48	16	3	10 17,45
4910 22 0010	T10	51	17	4	10 17,45
4910 22 0015	T15	54	18	5	10 18,00
4910 22 0020	T20	57	19	5	10 18,80
4910 22 0025	T25	60	20	10	10 18,80
4910 22 0027	T27	64	21	15	10 18,80
4910 22 0030	T30	70	24	20	10 20,15
4910 22 0040	T40	76	26	30	10 21,45
4910 22 0045	T45	83	29	40	10 26,30
4910 22 0050	T50	95	32	60	10 30,00
4910 22 0055	T55	108	35	125	10 41,60
4910 22 0060	T60	120	38	185	10 57,35

4906

Yuvarlak Başlı Allen Anahtar Takım Altı Köşe Uzun Boy (9 parça, mm)
Hex Key Wrench Ballpoint Long Pattern Set (9 Pcs, mm)



KOD CODE	İÇERİK CONTENTS	g	TL/Ad.
4906 00 3109	1.5 - 2 - 2.5 - 3 - 4 - 5 - 6 8 - 10	355	9 134,85

4910

Torx® Allen Anahtar Takımı (8 Parça)
Torx® Key Wrench Set (8 Pcs)

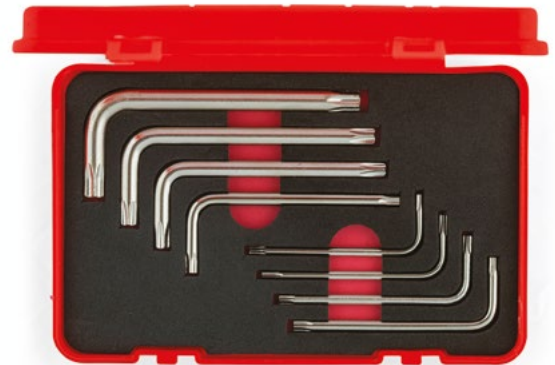

KOD CODE	İÇERİK CONTENTS	g	TL/Ad.
4910 00 7108	T9 - T10 - T15 T20 - T25 - T27 T30 - T40	155	8 150,90

4912

Kaset Allen Anahtar Takımı (7 Parça, mm)
Hex Key Wrench Folding Set (7 Pcs, mm)



Krom vanadyum
Chrom vanadium

KOD CODE	İÇERİK CONTENTS	g	TL/Ad.
4912 00 3107	2.5 - 3 - 4 - 5 - 6 - 8 - 10	355	1 135,15

4912

Kaset Allen Anahtar Takımı (7 Parça, mm)
Hex Key Wrench Folding Set (7 Pcs, mm)



Krom vanadyum
Chrom vanadium

KOD CODE	İÇERİK CONTENTS	g	TL/Ad.
4912 00 0007	1.5 - 2 - 2.5 3 - 4 - 5 - 6	130	1 91,00

4909

T Tipi Torx Allen Anahtar
T Handle Torx Key Wrench

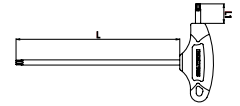

Krom vanadyum, Nikel kaplı, PP saplı
Chrom vanadium, Nickel plated, PP handle

KOD CODE	☆	L1 mm	L2 mm	g	TL/Ad.
4909 22 0009	T9	125	15	22	5 41,50
4909 22 0010	T10	125	15	22	5 42,30
4909 22 0015	T15	125	15	26	5 43,20
4909 22 0020	T20	125	15	44	5 43,55
4909 22 0025	T25	150	20	49	5 44,55
4909 22 0027	T27	150	20	62	5 49,50
4909 22 0030	T30	150	20	82	5 50,90
4909 22 0040	T40	175	25	100	5 52,80

4909

T Tipi Torx Allen Anahtar Takımı (8 Parça)
T Handle Torx Key Wrench Set (8 Pcs)



KOD CODE	İÇERİK CONTENTS	g	TL/Ad.
4909 00 8108	T9 - T10 - T15 - T20 T25 - T27 - T30 - T40	407	8 368,30

4920

T Tipi Allen Anahtar (mm)
Hex Key Wrench T - Handle (mm)

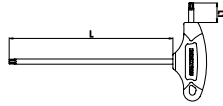

Krom Vanadyum
Chrom Vanadium

KOD CODE	mm	L mm	L1 mm	g	TL/Ad.	
4920 22 0025	2.5	110	14	20	5	25,60
4920 22 0030	3	125	17	23	5	26,10
4920 22 0040	4	140	20	45	5	29,25
4920 22 0050	5	155	23	58	5	31,25
4920 22 0060	6	170	26	100	5	35,70
4920 22 0070	7	185	30	125	5	37,50
4920 22 0080	8	200	34	150	5	41,85
4920 22 0100	10	220	40	240	5	66,70

4921

T Tipi Yuvarlak Başlı Allen Anahtar (mm)
Hex Key Wrench T - Handle Ballpoint (mm)

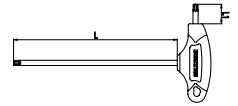

Krom Vanadyum
Chrom Vanadium

KOD CODE	mm	L mm	L1 mm	g	TL/Ad.	
4921 22 0025	2.5	110	14	20	5	33,25
4921 22 0030	3	125	17	23	5	33,65
4921 22 0040	4	140	20	45	5	37,80
4921 22 0050	5	155	23	58	5	40,55
4921 22 0060	6	170	26	100	5	46,35
4921 22 0070	7	185	30	125	5	48,60
4921 22 0080	8	200	34	150	5	52,25
4921 22 0100	10	220	40	235	5	86,65

4920

T Tipi Allen Anahtar Takımı (8 Parça, mm)
Hex Key Wrench T - Handle Set (8 Pcs, mm)



KOD CODE	İÇERİK CONTENTS	g	TL/Ad.	
4920 00 8108	2.5 - 3 - 4 - 5 6 - 7 - 8 - 10	760	8	293,95

4921

T Tipi Yuvarlak Başlı Allen Anahtar Takımı (8 Parça, mm)
Hex Key Wrench T - Handle Ballpoint Set (8 Pcs, mm)



KOD CODE	İÇERİK CONTENTS	g	TL/Ad.	
4921 00 8108	2.5 - 3 - 4 5 - 6 - 7 - 8 - 10	755	8	379,10

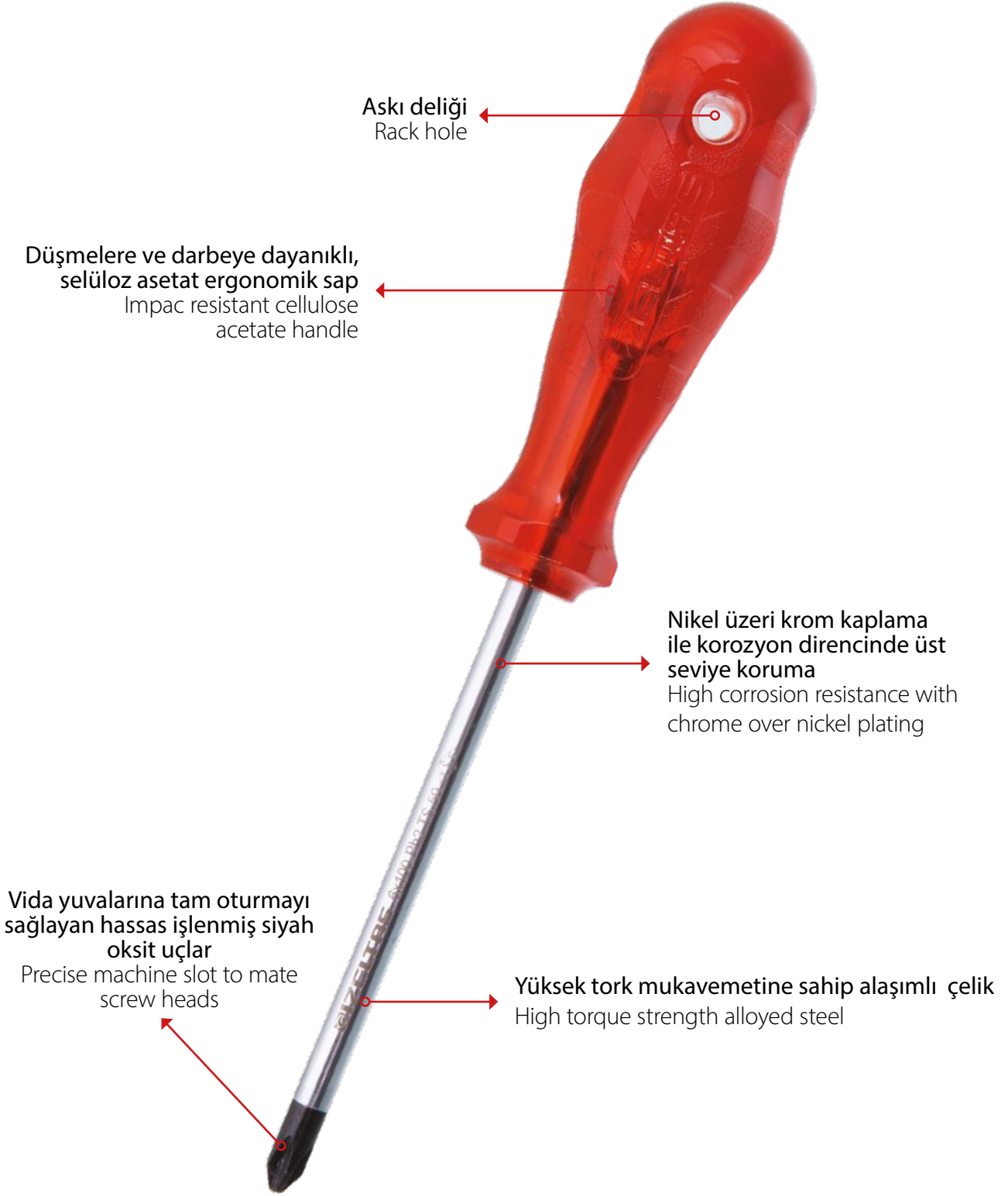

IZELTAS®

KESKİLER VE ÇEKİÇLER

CHISELS AND HAMMERS

Keskiler
Chisels

Zimbalar
Punches

Çekiçler
Hammers

Keserler
Adzes



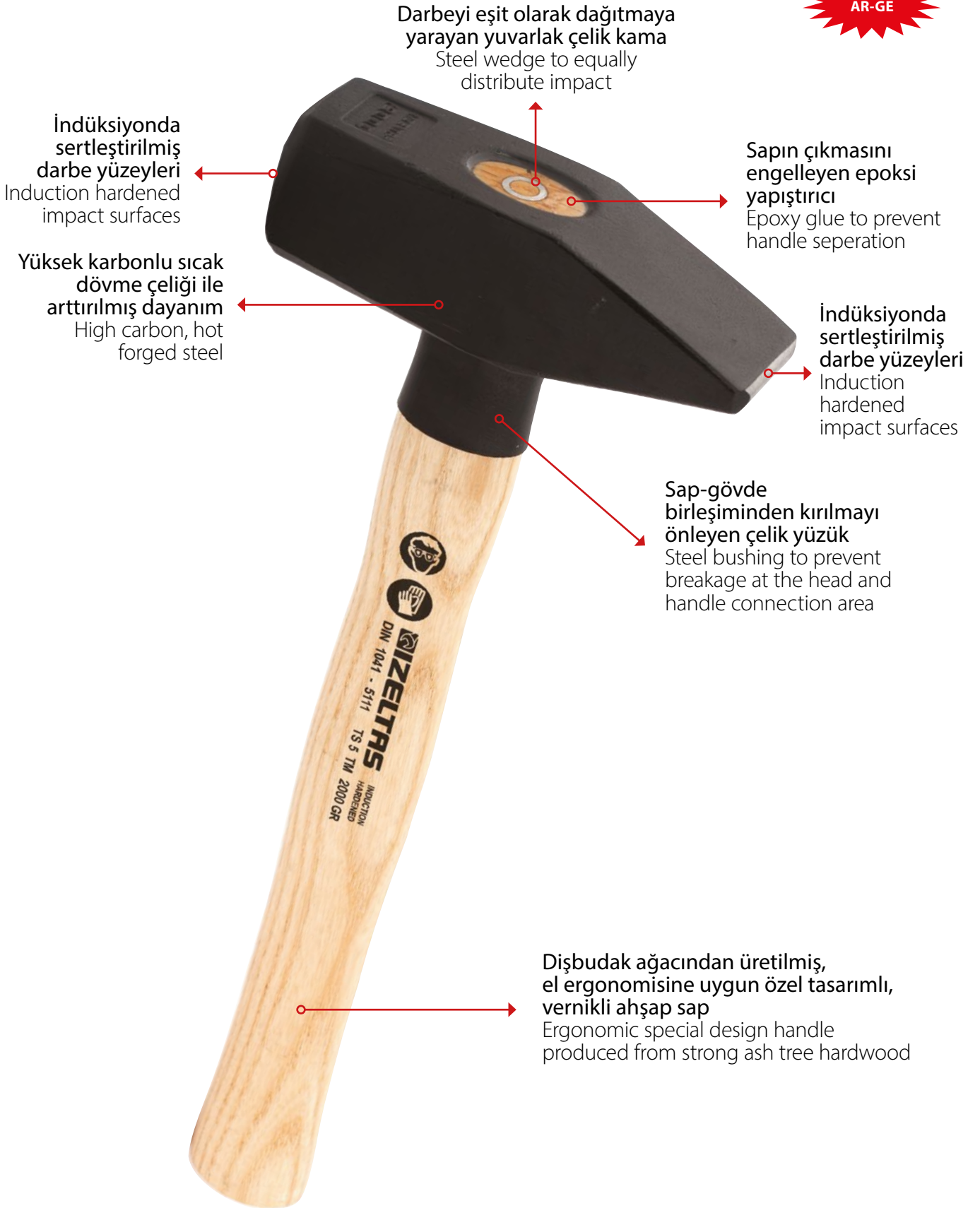

5010

Iskarpela (Düz) Wood Chisel

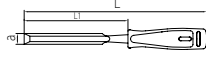

Özel alaşımli çelik, Uç indüksiyonda sertleştirilmiş, PP Saplı
Special steel, Induction hardened tips, PP Handle

KOD CODE	a mm	L mm	L1 mm	g	TL/Ad.	
5010 23 0006	6	245	120	115	5	44,90
5010 23 0008	8	245	122	125	5	48,00
5010 23 0010	10	245	124	135	5	50,75
5010 23 0012	12	245	126	135	5	55,65
5010 23 0014	14	245	128	145	5	57,55
5010 23 0016	16	255	130	150	5	61,55
5010 23 0018	18	255	132	160	5	66,75
5010 23 0020	20	255	134	170	5	74,25
5010 23 0022	22	255	136	190	5	80,45
5010 23 0024	24	255	138	195	5	86,90
5010 23 0026	26	255	140	200	5	90,05
5010 23 0030	30	260	146	205	5	96,15

5010

Iskarpela Takım (6 parça) Wood Chisel Set (6 Pcs)



KOD CODE	İÇERİK CONTENTS	g	TL/Ad.	
5010 00 8106	10 - 12 - 14 16 - 18 - 20	985	6	366,50

5500

Düz Keski Flat Cold Chisel

TS 492
DIN 6453



Özel alaşımli çelik, Krom kaplı
Special steel, Chrom plated

KOD CODE	L mm	a mm	g	TL/Ad.	
5500 23 0100	100	17	75	5	29,90
5500 23 0125	125	19	110	5	35,95
5500 23 0150	150	21	180	5	46,25
5500 23 0175	175	24	245	5	52,20
5500 23 0200	200	27	340	5	72,60
5500 23 0250	250	30	525	5	89,35
5500 23 0300	300	30	635	5	143,15

5500

Düz Keski (Kalkan İzoleli) Flat Cold Chisel (With Safety Handle)

TS 492
DIN 6453

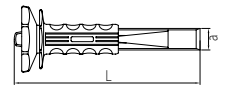

Özel alaşımli çelik, Krom kaplı
Special steel, Chrom plated

KOD CODE	L mm	a mm	g	TL/Ad.	
5500 23 1250	250	30	700	1	113,70
5500 23 1300	300	30	790	1	165,75

5510

Tesviyeci Düz Keski
Flat Cold Chisel Octagonal

TS 492
DIN 6453



Krom vanadyum, Krom kaplı
Chrom vanadium, Chrom plated

KOD CODE	L mm	a mm	g	TL/Ad.
5510 23 0125	125	10	75	10 40,95
5510 23 0150	150	14	125	10 51,20

5520

Tırnak Keski
Cross Cut Chisel



Krom vanadyum, Krom kaplı
Chrom vanadium, Chrom plated

KOD CODE	L mm	a mm	g	TL/Ad.
5520 23 0125	130	5	70	10 45,95
5520 23 0150	150	6	110	10 54,80

5540

Nokta Zımba
Center Punch

DIN 7250

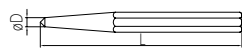

Krom vanadyum, Elektrostatik boyanmış
Chrom vanadium, Electrostatically painted

KOD CODE	L mm	L inch	øD mm	g	TL/Ad.
5540 24 4120	120	4 3/4"	4	65	10 31,65
5540 24 5120	120	4 3/4"	5	95	10 37,25
5540 24 5150	150	6"	5	115	10 41,25
★5540 24 0412	120	4 3/4"	4	65	10 31,25

★ Krom Kaplı / Chrom Plated

5545

Konik Pim Zımba
Drift Punch

DIN 6458

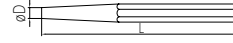

Krom vanadyum, Elektrostatik boyanmış
Chrom vanadium, Electrostatically painted

KOD CODE	L mm	L inch	øD mm	g	TL/Ad.
5545 24 0002	120	4 3/4"	2	90	10 28,20
5545 24 0003	120	4 3/4"	3	90	10 30,70
5545 24 0004	120	4 3/4"	4	90	10 34,55
5545 24 0005	120	4 3/4"	5	95	10 35,25
5545 24 0006	120	4 3/4"	6	95	10 51,95
5545 24 0007	120	4 3/4"	7	100	10 54,15
5545 24 0008	150	6"	8	125	10 56,25
5545 24 0009	150	6"	9	130	10 57,55
5545 24 0010	150	6"	10	130	10 58,70
5545 24 0012	150	6"	12	180	10 61,35
★5545 24 0103	120	4 3/4"	3	90	10 32,10

5550

Düz Pim Zımba
Split Pin Punch

DIN 6450

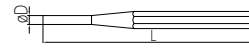

Krom vanadyum, Elektrostatik boyanmış
Chrom vanadium, Electrostatically painted

KOD CODE	L mm	L inch	øD mm	g	TL/Ad.
5550 24 0002	150	6"	2	70	5 37,70
5550 24 0003	150	6"	3	65	5 37,70
5550 24 0004	150	6"	4	65	5 38,35
5550 24 0005	150	6"	5	65	5 38,35
5550 24 0006	150	6"	6	70	5 38,65
5550 24 0007	150	6"	7	100	5 40,25
5550 24 0008	150	6"	8	105	5 43,10
5550 24 0009	150	6"	9	110	5 43,70
5550 24 0010	150	6"	10	120	5 44,15
★5550 24 0105	150	6"	5	65	5 36,10

5550

Düz Pim Zımba Takımı (6 Parça)
Split Pin Punch (6 Pcs)



KOD CODE	İÇERİK CONTENTS	g	TL/Ad.
5550 00 1006	3 - 4 - 5 - 6 - 7 - 8	865	6 236,40

(★) İşaretili olan ürünler stoklarla sınırlıdır.
Limited with stocks.

5600

Keski Zimba Seti (6 Parça) Chisel And Punch Set (6 Pcs)



KOD CODE	İÇERİK CONTENTS	g	Ad.	TL/Ad.
5600 00 6106	125 Tevsiyeci Düz Keski 125 Flat Cold Chisel Octagonal	865	6	237,55
	150 Tevsiyeci Düz Keski 150 Flat Cold Chisel Octagonal			
	130 Tırnak Keski 130 Cross Cut Chisel			
	4x120 Nokta Zimba 4x120 Center Punch			
	5x150 Düz Pim Zimba 5x150 Split PinPunch			
	3x120 Konik Pim Zimba 3x120 Drift Punch			

5700

Kayış Zimba Belt Punch

DIN 7200



Krom vanadyum, Elektrostatik boyanmış
Chrom vanadium, Electrostatically painted

KOD CODE	ØD mm	L mm	g	Ad.	TL/Ad.
★5700 24 1021	21	150	250	5	100,80
★5700 24 1022	22	150	260	5	102,15
★5700 24 1023	23	160	305	5	103,70
★5700 24 1024	24	160	320	5	110,40
★5700 24 1025	25	170	365	5	116,20
★5700 24 1026	26	170	355	5	122,50
★5700 24 1029	29	190	465	5	139,20
★5700 24 1030	30	190	475	5	141,15
★5700 24 1032	32	190	500	5	149,30

5700

Kayış Zimba Belt Punch

DIN 7200

TSEK

5700

Kayış Zimba Takımı Belt Punch Set



Krom vanadyum, Elektrostatik boyanmış
Chrom vanadium, Electrostatically painted

KOD CODE	ØD mm	L mm	g	Ad.	TL/Ad.
5700 24 0003	3	105	35	10	24,20
5700 24 0004	4	105	40	10	25,30
5700 24 0005	5	110	50	10	27,50
5700 24 0006	6	110	60	10	28,00
5700 24 0007	7	115	75	10	30,85
5700 24 0008	8	115	90	10	32,80
5700 24 0009	9	120	100	10	36,60
5700 24 0010	10	120	110	10	38,95
5700 24 0011	11	125	130	5	41,90
5700 24 0012	12	125	165	5	50,15
5700 24 0013	13	130	165	5	52,80
5700 24 0014	14	130	180	5	58,00
5700 24 0015	15	135	245	5	66,55
5700 24 0016	16	135	300	5	72,85
5700 24 0017	17	140	365	5	79,65
5700 24 0018	18	140	380	5	86,90
5700 24 0019	19	145	405	5	94,45
5700 24 0020	20	145	450	5	100,60



KOD CODE	İÇERİK CONTENTS	g	Ad.	TL/Ad.
5700 00 2110	3 - 4 - 5 - 6 - 7 8 - 9 - 10 - 11 - 12	845	10	336,25
5700 00 2112	3 - 4 - 5 - 6 - 7 - 8 - 9 10 - 11 - 12 - 13 - 14	1180	12	447,05

5800

Tesviyeci Çekiç
Machinist Hammer

TS 5-1
DIN 1041
TSE



İZELTAS YOUTUBE

Yedek parça sayfa 201
Spare parts page 201

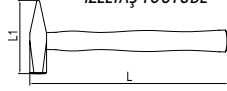

Özel alaşımlı çelik, İndüksiyonda sertleştirilmiş, Elektrostatik boyanmış
Special steel, Induction hardened, Electrostatically painted

KOD CODE	L mm	L1 mm	g	g	TL/Ad.
5800 25 0100	260	82	100	160	10 52,65
5800 25 0200	280	95	200	260	10 57,35
5800 25 0300	300	105	300	395	10 69,50
5800 25 0500	320	118	500	600	5 80,45
5800 25 1000	360	135	1000	1095	5 112,35
5800 25 1500	380	145	1500	1630	5 152,70
5800 25 2000	400	155	2000	2100	5 187,80

5810

Emniyet Çekici
Safety Hammer

TS 5-1

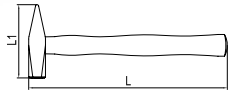

Özel alaşımlı çelik, İndüksiyonda sertleştirilmiş, Elektrostatik boyanmış
Special steel, Induction hardened, Electrostatically painted

KOD CODE	L mm	L1 mm	g	g	TL/Ad.
5810 25 1000	360	135	1000	1095	5 151,65
5810 25 1500	380	145	1500	1630	5 209,85
5810 25 2000	400	155	2000	2100	5 259,20

Emniyet çekici

Çekiç kafası ile sapın birleşiminde yuvarlak kama ve yapışkan malzeme kullanılarak sağlamlığı artırılmış ayrıca birleşimi çelik sac malzeme ile desteklenerek güvenli kullanım sağlanmıştır.

Safety Hammer

Connection between the hammer head and the handle is ensured by circular wedge and epoxy glue, while it is also reinforced by sheet metal for safe use.

5850

Plastik Çekiç
Plastic Hammer

TS 5

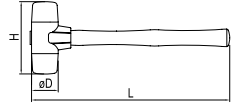

Yedek parça sayfa 201
Spare parts page 201

Darbeye dayanıklı, Kolay değiştirilebilir başlık
Durable and easily changeable heads

KOD CODE	L mm	σD mm	H mm	g	TL/Ad.
5850 25 0030	300	30	100	345	5 71,20
5850 25 0040	320	40	110	645	5 86,65
5850 25 0050	350	50	120	1015	5 108,30

5870

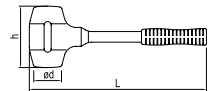

Lastik Çekiç
Rubber Hammer

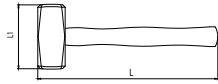

KOD CODE	L mm	σd mm	h mm	g	g	TL/Ad.
5870 25 0400	300	47	104	400	610	5 145,80

(★) İşaretili olan ürünler stoklarla sınırlıdır.
Limited with stocks.

5865
Madırğa
Mallet

 **Yedek parça sayfa 201**
Spare parts page 201
Özel alaşımli çelik
Special steel

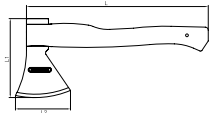
KOD CODE	L mm	L1 mm				TL/Ad.
5865 25 1000	260	95	1000	1210	5	138,95
5865 25 1500	280	110	1500	1770	5	166,00

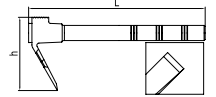

6410
Nacak
Hatchet

 **Yedek parça sayfa 201**
Spare parts page 201
Özel alaşımli çelik, İndüksiyonda sertleştirilmiş, Elektrostatik boyanmış
Special steel, Induction hardened, Electrostatically painted

KOD CODE	L mm	L1 mm	L2 mm				TL/Ad.
6410 25 0800	380	165	115	800	1065	1	277,50

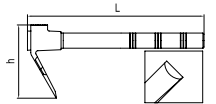
6400
Keser
Adze

 **Yedek parça sayfa 201**
Spare parts page 201
Özel alaşımli çelik, İndüksiyonda sertleştirilmiş, Elektrostatik boyanmış, PVC ağız koruyucu
Special steel, Induction hardened, Electrostatically painted, PVC cutting edge protector

KOD CODE	L mm	h mm				TL/Ad.
6400 25 0600	400	125	400	550	5	153,20

6401
Usta Keseri
Master Adze

 **Yedek parça sayfa 201**
Spare parts page 201
Özel alaşımli çelik, İndüksiyonda sertleştirilmiş, Elektrostatik boyanmış, PVC ağız koruyucu
Special steel, Induction hardened, Electrostatically painted, PVC cutting edge protector

KOD CODE	L mm	h mm				TL/Ad.
6401 25 0600	400	125	400	540	5	153,20



ZELTAS
DIN 6131 - 5232

INDUCTION
HARDENED
800 GR.

6410



ZELTAS

GENEL EL ALETLERİ

GENERAL HAND TOOLS

Servis Aletleri
Service Equipment

Perçin Tabancası
Riveting Pliers

İşkenceler
Clamps

İnşaat Ekipmanları
Construction Equipment

Metreler
Measuring Tapes

Mengene
Forged Steel Vice

Su Terazisi
Straight Level

Gres Pompası
Grease Gun



KABLO SIYIRICI (KANCA BIÇAKLI) / CABLE STRIPPER (WITH HOOKED BLADE)

Tüm standart kabloları
sıyırmak için daha uzun ömür,
daha hızlı kesme ve daha az
aşınma sağlayan özel
titanyum nitrür (TIN)
kaplama
Tin plated long lasting/
fast cutting blade to strip all
standard cables

Özel alışımli çelikten
sertleştirilmiş ve kaplanmış
kanca bıçak
Plated special alloy hardened
steel hook blade

Kapasite 8-28mm
çaplı kablolar
için uygun
Suitable for 8-28mm
diameter cables

Özel kaydırmaz formu
dayanıklı polyamid (PA) sap
Non-slip and durable
polyamid handle

Çevirerek kolay
bıçak yükseklik ayarı
Easy-to-rotate blade height adjuster

03750

Kablo Sıyrıcı (Kanca Bıçaklı)
Cable Stripper (With Hooked Blade)



 **Yedek parça sayfa 201**
Spare parts page 201

KOD CODE	ÖLÇÜ SIZE	g	TL/Ad.
03750 50 020	Ø8-28	79	5 105,30

03753

Mekanik Kablo Sıyrıcı
Mechanical Cable Stripper



KOD CODE	ÖLÇÜ SIZE	g	TL/Ad.
03753 50 054	0,5/4	100	5 180,15

03752

Kablo Sıyrıcı
Cable Stripper



 **Yedek parça sayfa 201**
Spare parts page 201



İZELTAS YOUTUBE

KOD CODE	ÖLÇÜ SIZE	g	TL/Ad.
03752 50 625	Tek 6/300 Çok 1.5/25	70	5 95,80

05881

Krom Şerit Metre
Chrom Steel Case, Measuring tapes



KOD CODE	ÖLÇÜ SIZE M	g	TL/Ad.
05881 50 013	3	160	5 47,30
05881 50 015	5	220	5 53,40

03751

Koaksiyel Kablo Sıyrıcı
Coaxial Cable Stripper



İZELTAS YOUTUBE

KOD CODE	ÖLÇÜ SIZE	g	TL/Ad.
03751 50 012	Dış (1) İç (2)	20	5 136,70

05881

Plastik Şerit Metre
Plastic Steel Case, Measuring tapes



KOD CODE	ÖLÇÜ SIZE M	g	TL/Ad.
05881 50 003	3	145	5 39,70
05881 50 005	5	200	5 47,70

05886**Arazi Tipi Fiberglas Şerit Metre (Saplı)**
Fiberglass Measuring Tape Field Type (With Holder)

KOD CODE	ÖLÇÜ SIZE M	g		TL/Ad.
05886 50 020	20	520	1	110,60
05886 50 030	30	585	1	118,10
05886 50 050	50	820	1	189,70

05880**Su Terazisi**
Straight Level**Alüminyum gövde**
Aluminyum body

KOD CODE	L mm	g		TL/Ad.
05880 50 040	400	250	5	106,20
05880 50 050	500	300	5	115,25
05880 50 060	600	350	5	125,25
05880 50 070	700	400	5	134,50
05880 50 080	800	450	5	145,30
05880 50 100	1000	500	5	165,40
05880 50 120	1200	550	5	195,75
05880 50 150	1500	600	5	225,55
05880 50 200	2000	800	5	315,10

05887**Kumpas**
Vernier**Sürgülü, Stoplu**
Sliding and with stop

KOD CODE	L mm	g		TL/Ad.
05887 50 150	150	155	5	391,95

05890**Testere Kolu**
Hacksaw Frame**Yedek parça sayfa 202**
Spare parts page 202

KOD CODE	L mm	g		TL/Ad.
05890 50 830	300	540	5	149,60

6735**Dal Budama Testeresi**
Pruning Saw**Yedek parça sayfa 202**
Spare parts page 202

KOD CODE	L mm	g		TL/Ad.
6735 27 0300	300	400	5	160,55

05895**Kıl Testere Kolu (Ağaç saplı)**
Hacksaw Frame (Wooden Handle)

KOD CODE	L mm	g		TL/Ad.
*05895 50 150	150	95	10	32,55

05901

Sentil (20 Parça, mm)
Feeler Gauges (20 Pcs, mm)



KOD CODE	ÖLÇÜ SIZE mm	g	TL/Ad.
05901 50 020	0.05 - 1	90	10 36,35

6195

Perçin Tabancası
Riveting Pliers



KOD CODE	ÖLÇÜ SIZE	CAPACITY mm	g	TL/Ad.
6195 26 0260	260	2 - 2.5 - 3 - 3.2	625	1 169,05

05902

Sentil (20 Parça, SAE)
Feeler Gauges (20 Pcs, SAE)



KOD CODE	ÖLÇÜ SIZE inch	g	TL/Ad.
05902 50 020	2 - 35/1000"	65	10 56,85

6220

Spiralli Mıknatıs
Flexible Magnet Holder

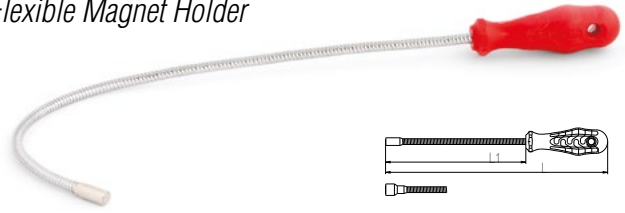

KOD CODE	KAPASİTE g	L mm	L1 mm	g	TL/Ad.
6220 26 0500	500	465	375	100	10 99,30
6220 26 1000	1000	465	375	105	10 105,15

6225

Madeni Yağdanlık (Flexible Uçlu)
Oiler With Flexible Spout



KOD CODE	ÖLÇÜ SIZE cc	g	TL/Ad.
6225 26 0200	200	170	5 58,50
6225 26 0300	300	200	5 65,85
6225 26 0500	500	225	5 72,25

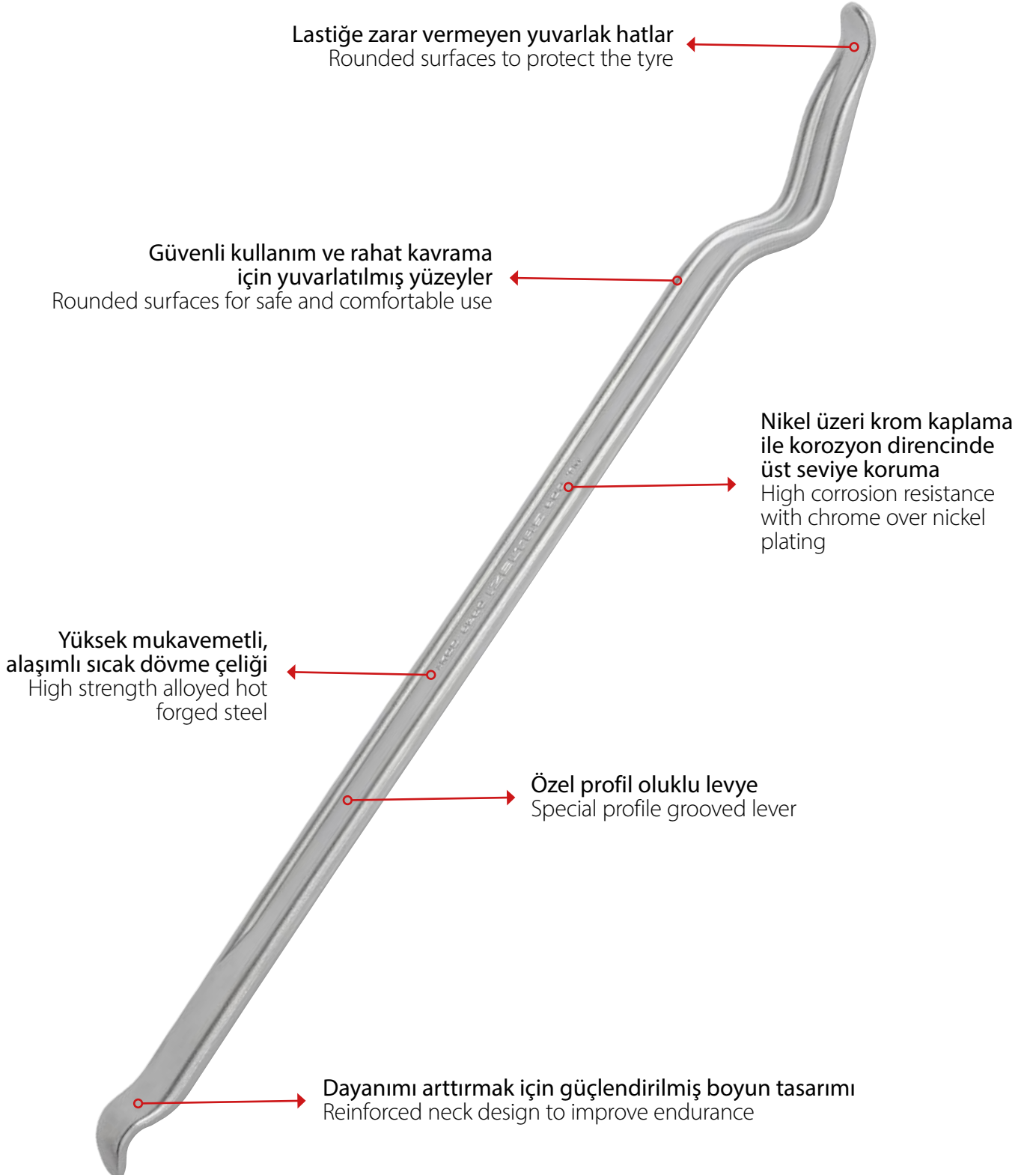

6230

Gres Pompası
Grease Gun



 Yedek parça sayfa 202
Spare parts page 202

KOD CODE	ÖLÇÜ SIZE cc	g		TL/Ad.
6230 26 0300	300	1200	1	101,50
6230 26 0500	500	1320	1	119,05

6235

Sübap Ayar Tornavidası
Valve Adjustment Spinner



KOD CODE	L mm	g		TL/Ad.
★6235 19 0220	220	90	10	36,60

6240

Tapa Anahtarı (iki ağız)
Offset Wrench For Carter Case



KOD CODE	ÖLÇÜ mm	g		TL/Ad.
6240 26 0810	8x10	250	10	53,45

6350

Levye Oluklu
Tyre Lever, Straight

TSEK



Krom vanadyum, Krom kaplı
Chrom vanadium, Chrom plated

KOD CODE	L mm	L inch	g		TL/Ad.
6350 26 0300	300	12"	265	5	50,75
6350 26 0400	400	16"	440	5	63,95
6350 26 0500	500	20"	675	5	89,00
6350 26 0600	600	24"	900	5	108,65

6360

Levye Oluklu Kıvrık Uçlu
Tyre Lever, Bent

TSEK



Krom vanadyum, Krom kaplı
Chrom vanadium, Chrom plated

KOD CODE	L mm	L inch	g		TL/Ad.
6360 26 0600	600	24"	910	5	120,05

6370

Yağ Filtresi Sökeceği
Band Type Oil Filter Wrench



KOD CODE	Ø mm	g		TL/Ad.
6370 26 0100	75 - 100	335	5	79,30

6371

Üç Ayaklı Yağ Filtresi Sökeceği
Oil Filter Hook 3 Arms Pattern



KOD CODE	Ø mm	g		TL/Ad.
★6371 26 3120	63 - 120	700	5	151,25

6375

Çift Yönlü Üç Ayaklı Yağ Filtresi Sökeceği
Left and Right Hand Operation, Triple Leg Oil Filter Wrench

**3/8" - 1/2"**

KOD CODE	Ø mm	g	□	TL/Ad.
6375 26 6512	75-120	605	5	277,50

6380

Çift Zincirli Yağ Filtresi Sökeceği
Oil Filter Wrench With Double Chain



KOD CODE	Ø mm	g	□	TL/Ad.
6380 26 6016	60-160	380	5	708,60

06373

Kayıslı Yağ Filtresi Sökeceği
Strap Wrench



KOD CODE	Ø mm	g	□	TL/Ad.
06373 50 140	60x140	245	5	194,40

06374

Zincirli Yağ Filtresi Sökeceği
Chain Wrench



KOD CODE	Ø mm	g	□	TL/Ad.
06374 50 140	60x140	390	5	156,35

06375

Ayarlı Yağ Filtresi Sökeceği
Adjustable Slot Type Oil Filter Wrench



 Yedek parça sayfa 201
Spare parts page 201

KOD CODE	Ø mm	g	□	TL/Ad.
06375 50 100	65-110	215	5	85,75

06376

Sac Yağ Filtresi Sökeceği
Oil Filter Wrench



KOD CODE	Ø mm	inch	g	□	TL/Ad.
★06376 50 108	108	3/8"	240	5	52,85

06390

Segman Çemberi Piston Ring Compressor



KOD CODE	Ø mm	g	TL/Ad.
06390 50 125	125	235	5 154,75
06390 50 175	175	505	5 316,35

07415

Sıralı Tel Fırça (Ağaç Saplı) Hand Brush (Wooden Handle)



KOD CODE	ÖLÇÜ SIZE	g	TL/Ad.
07415 50 003	3 SIRA 3 RAWS	125	5 12,65
07415 50 004	4 SIRA 4 RAWS	135	5 13,40
07415 50 005	5 SIRA 5 RAWS	145	5 14,95
07415 50 006	6 SIRA 6 RAWS	170	5 16,00

07416

Kıvrık Uçlu Fırça (Plastik Saplı) Hand Brush (PP Handle)



KOD CODE	L mm	g	TL/Ad.
07416 50 001	270	110	5 20,55

07410

Makaralı Uzatma Kablosu (El Tipi) Extension Cord Reel (With Handle)



Kablo / Cable ø 3x1.5 mm

KOD CODE	MODEL	ÖLÇÜ SIZE	g	TL/Ad.
07410 50 010	el tipi / with handle	10	1400	1 300,40

07410

Makaralı Uzatma Kablosu (Ayaklı) Extension Cord Reel (With Stand)



Kablo / Cable ø 3x1.5 mm

KOD CODE	MODEL	ÖLÇÜ SIZE	g	TL/Ad.
07410 50 025	ayaklı / with stand	25	4130	1 585,75
07410 50 050	ayaklı / with stand	50	6745	1 819,90

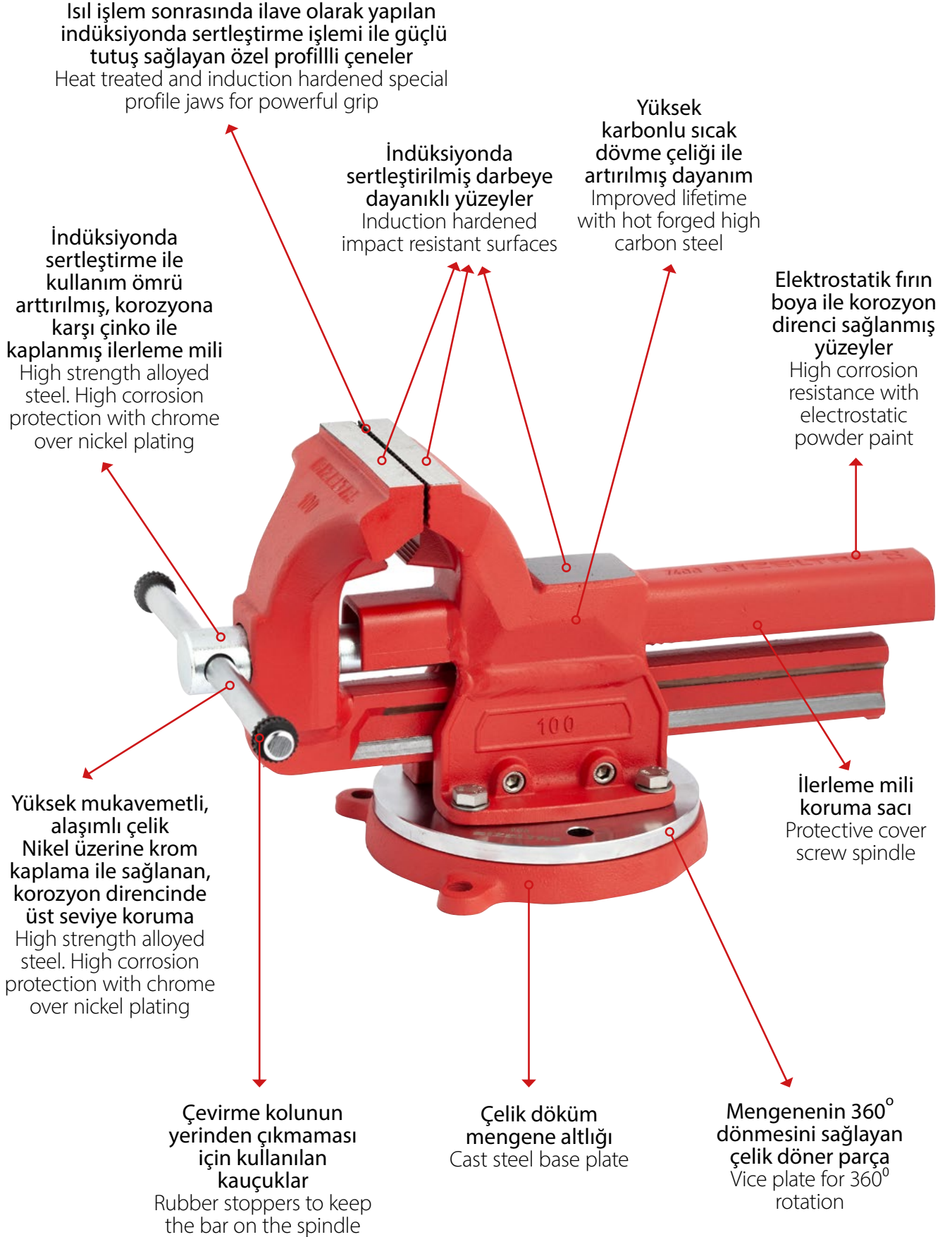

DÖVME ÇELİK MENGENE/TFORGED STEEL VICE WITH SWIVEL BASE

7401

Mengene Döner Tablası Swivel Base of Vice

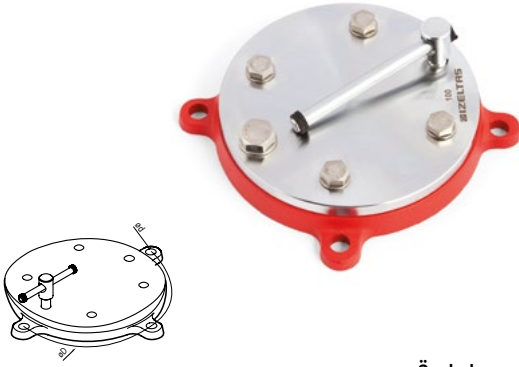

Özel alaşım çelik, Krom kaplı
Special steel, Chrom plated

KOD CODE	ÖLÇÜ SIZE	σd mm	σD mm	g	TL/Ad.
7401 30 0100	100	10.5	160	1550	1 256,10
7401 30 0125	125	12.5	200	2700	1 338,40
7401 30 0150	150	12.5	240	3800	1 410,80
7401 30 0175	175	12.5	280	6650	1 464,45

7400

Dövme Çelik Mengene Forged Steel Vice



Özel alaşım çelik, Fırın boya
Special steel, Electrostatic Paint

KOD CODE	B mm	W mm	H mm	L mm	g	TL/Ad.
7400 30 0100	100	125	148	440	5000	1 869,90
7400 30 0125	125	155	183	550	11000	1 1197,65
7400 30 0150	150	180	220	675	20000	1 1531,75
7400 30 0175	175	205	245	760	29000	1 1884,60

7400

Dövme Çelik Mengene (Döner Tabla dahil) Forged Steel Vice with Swivel Base





Özel alaşım çelik, Fırın boya
Special steel, Electrostatic Paint

KOD CODE	B mm	g	TL/Ad.
7400 00 0100	100	6550	1 1126,00
7400 00 0125	125	13700	1 1536,05
7400 00 0150	150	23800	1 1942,55
7400 00 0175	175	35650	1 2349,05



İşkence (Marangoz Mengenesi Plastik Ağzılı)
Carpenter Screw Clamp

Darbeye dayanıklı çeneler
Impact resistant cast iron jaws

KOD CODE		a mm	b mm			TL/Ad.
7300 30 3012	30x12	300	120	1605	5	188,75
7300 30 4012	40x12	400	120	1780	5	238,90
7300 30 5012	50x12	500	120	1935	5	244,90
7300 30 6012	60x12	600	120	2080	5	255,65
7300 30 8012	80x12	800	120	2470	5	271,15
7300 30 1012	100x12	1000	120	2790	5	309,50

Mini İşkence
Mini Clamp

Alaşımlı alüminyum çeneler
Alloyed aluminum jaws

KOD CODE		a mm	b mm			TL/Ad.
7310 30 1005	10x5	100	50	250	5	72,25
7310 30 1505	15x5	150	50	280	5	76,15
7310 30 2005	20x5	200	50	310	5	78,95
7310 30 2505	25x5	250	50	330	5	82,30
7310 30 3005	30x5	300	50	360	5	85,20

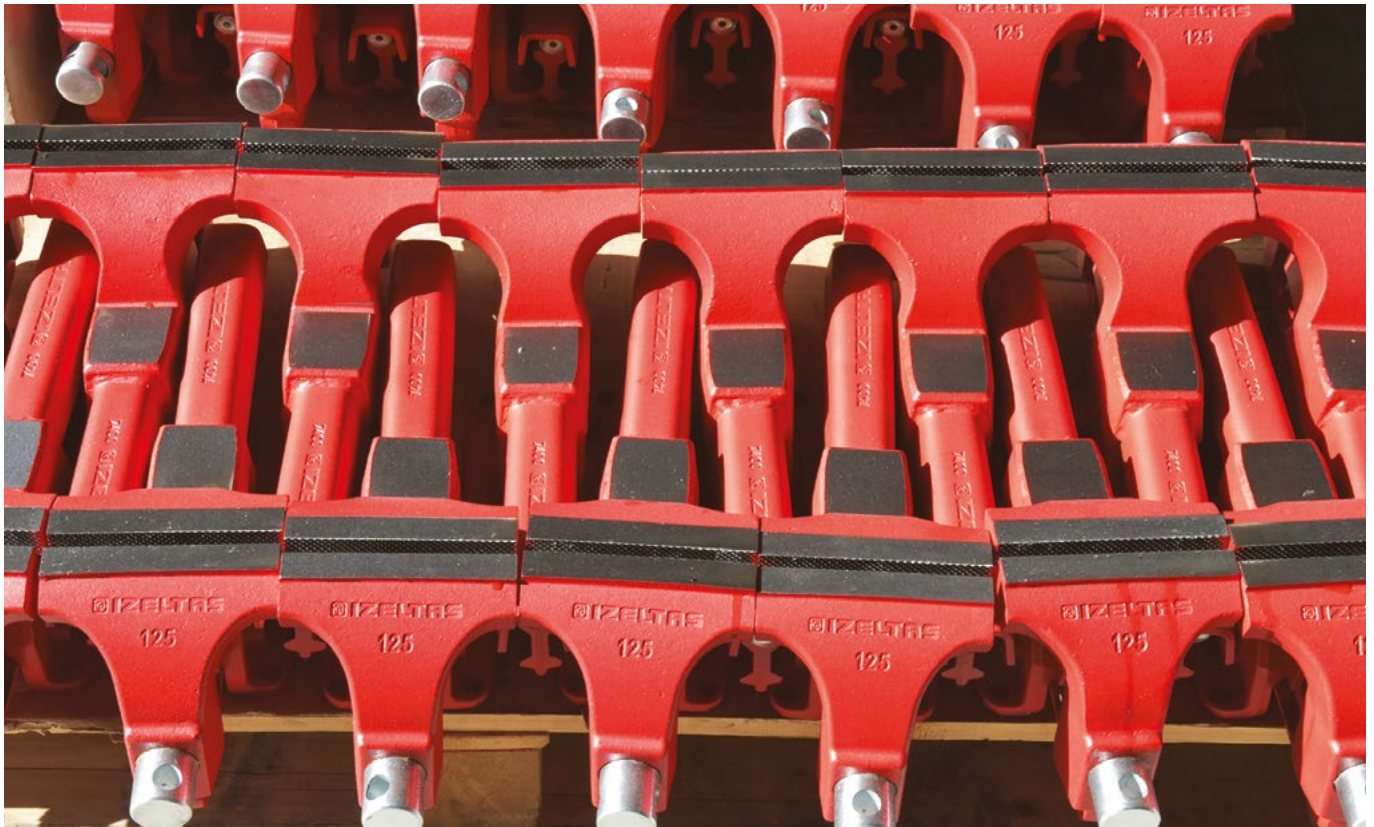

IZELTAS®

MAKASLAR

SHEARS

Demir Kesme Makası
Bolt Cutters

Saç Makasları
Sheet Metal Cutters

Plastik Boru Kesme Makası
Plastic Pipe Cutters

Bağ Makasları
Prunnig Shears



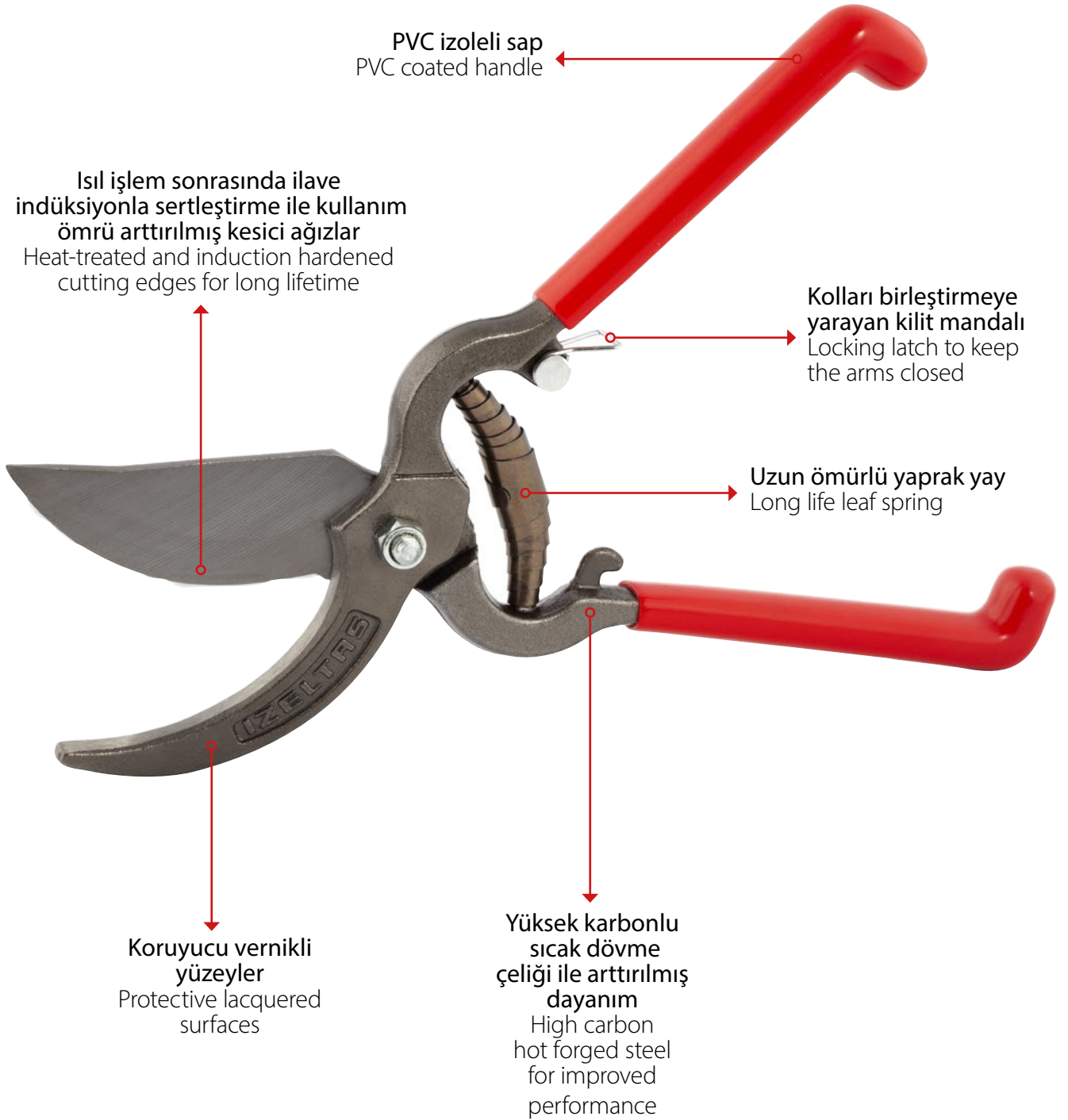

2350

Demir Kesme Makası Bolt Cutters



 Yedek parça sayfa 200
Spare parts page 200

Özel alaşımlı çelik, Kesici ağızlar indüksiyonda sertleştirilmiş,
Elektrostatik boyanmış çeneler ve bağlantı parçaları dövme
Special steel, Cutters induction hardened,
Electrostatically painted jaws and connection parts drop forged

KOD CODE	L mm	L inch	KAPASİTE CAPACITY Ø mm	g	TL/Ad.
2350 27 0018	450	18"	6 - 8	1510	1 375,70
2350 27 0024	600	24"	8 - 10	2350	1 553,05
2350 27 0030	750	30"	9 - 13	3750	1 865,80
2350 27 0036	900	36"	11 - 16	5500	1 1120,50

2350

Demir Kesme Makası Sehpaı Dolu Bolt Cutters Frame



KOD CODE	İÇERİK CONTENTS	g	TL/Ad.
2350 00 6104	18"(450) - 24"(600) 30"(750) - 36"(900)	21.110	4 3500,05

6205

Alüminyum Ve Sac Kesme Makası Sağ Snip For Aluminum and Metal Sheet (Right)



Özel alaşımlı çelik, Kesici ağızlar indüksiyonda sertleştirilmiş,
Special steel, Cutters induction hardened,

KOD CODE	L mm	L inch	g	TL/Ad.
6205 27 0240	240	10"	380	5 124,00

6206

Alüminyum Ve Sac Kesme Makası Sol Snip For Aluminum and Metal Sheet (Left)



Özel alaşımlı çelik, Kesici ağızlar indüksiyonda sertleştirilmiş,
Special steel, Cutters induction hardened

KOD CODE	L mm	L inch	g	TL/Ad.
6206 27 0240	240	10"	380	5 124,00

6207

Alüminyum Ve Sac Kesme Makası Düz Snip For Aluminum and Metal Sheet (Flat)



Özel alaşımlı çelik, Kesici ağızlar indüksiyonda sertleştirilmiş,
Special steel, Cutters induction hardened

KOD CODE	L mm	L inch	g	TL/Ad.
6207 27 0240	240	10"	380	5 124,00

6210

Kaportacı Makası (Sağ)
Punch Snip (Right)

DIN 6438



Özel alaşımli çelik, Kesici ağızlar induksiyonda sertleştirilmiş, PVC izoleli
Special steel, Cutters induction hardened, PVC insulated

KOD CODE	L mm	L inch	g	TL/Ad.	
6210 27 0250	250	10"	555	5	155,00
6210 27 0275	275	11"	600	5	169,55
6210 27 0300	300	12"	640	5	203,25

6211

Kaportacı Makası (Sol)
Punch Snip (Left)

DIN 6438



Özel alaşımli çelik, Kesici ağızlar induksiyonda sertleştirilmiş, PVC izoleli
Special steel, Cutters induction hardened, PVC insulated

KOD CODE	L mm	L inch	g	TL/Ad.	
6211 27 0250	250	10"	535	5	155,00
6211 27 0275	275	11"	605	5	169,55
6211 27 0300	300	12"	665	5	203,25

6820

Tenekeci Makası
Tinman's Snip

TSEK



Özel alaşımli çelik, Kesici ağızlar induksiyonda sertleştirilmiş, PVC izoleli
Special steel, Cutters induction hardened, PVC insulated

KOD CODE	L mm	L inch	g	TL/Ad.	
6820 27 0200	200	8"	320	5	107,90
6820 27 0250	250	10"	575	5	137,80
6820 27 0300	300	12"	870	5	150,20

6821

Tenekeci Makası (Yaylı)
Tinman's Snip (With Spring)

TSEK



Özel alaşımli çelik, Kesici ağızlar induksiyonda sertleştirilmiş, PVC izoleli
Special steel, Cutters induction hardened, PVC insulated

KOD CODE	L mm	L inch	g	TL/Ad.	
6821 27 0250	250	10"	575	5	149,65
6821 27 0300	300	12"	895	5	163,75

6800

Kuyumcu Makası (Düz)
Jeweller's Snip (Straight)

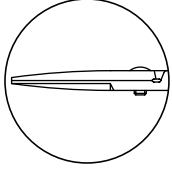

KOD CODE	L mm	L inch	g	TL/Ad.
6800 27 0180	180	7 1/8"	140	5 143,45

6815

Tel Kesme Makası
Bolt Cutters



KOD CODE	L mm	L inch	g	TL/Ad.
6815 27 0200	200	8"	295	5 63,95

6801

Kuyumcu Makası (Eğri)
Jeweller's Snip (Curved)

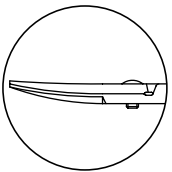

KOD CODE	L mm	L inch	g	TL/Ad.
6801 27 0180	180	7 1/8"	140	5 156,90

6740

Kombine Makas
Multi Purpose Scissors



KOD CODE	L mm	L inch	g	TL/Ad.
6740 27 0140	140	5 1/2"	60	5 121,95
6740 27 0190	190	7 1/2"	120	5 138,15

6710**Bağ Makası (Lüks)**
Pruning Shears (Lux)

IZELTAS YOUTUBE

Özel alaşımlı çelik, Kesici ağızlar induksiyonda sertleştirilmiş, PVC izoleli
Special steel, Cutters induction hardened, PVC insulated

KOD CODE	L mm	L inch	g	TL/Ad.
6710 27 0230	230	9"	390	5 119,50

6715**Bağ Makası (Comfort)**
Pruning Shears (Comfort)

Özel alaşımlı çelik, PVC izoleli
Special steel, PVC insulated

KOD CODE	L mm	L inch	g	TL/Ad.
6715 27 0225	225	9"	340	5 182,00

6720**Bağ Makası (Hafif Tip)**
Pruning Shears (Light)

Alüminyum gövde, PVC izoleli
Aluminum forged body, PVC insulated

KOD CODE	L mm	L inch	g	TL/Ad.
6720 27 0220	220	8 5/8"	265	5 211,05

6712**Elma Makası**
Pruning Shears (Fruit)

Özel alaşımlı çelik, Kesici ağızlar induksiyonda sertleştirilmiş, PVC izoleli
Special steel, Cutters induction hardened, PVC insulated

KOD CODE	L mm	L inch	g	TL/Ad.
6712 27 0210	210	8 1/4"	365	5 211,40

6760**Narenciye Makası**
Pruning Shears (Citrus)

Özel alaşımlı çelik, Kesici ağızlar induksiyonda sertleştirilmiş, PVC izoleli
Special steel, Cutters induction hardened, PVC insulated

KOD CODE	L mm	L inch	g	TL/Ad.
★6760 27 0125	125	5"	125	5 95,10

06760

Plastik Boru Kesme Makası Plastic Pipe Cutter



 Yedek parça sayfa 202
Spare parts page 202

KOD CODE	Ø mm	g	□	TL/Ad.
06760 50 042	42	400	5	410,75
06760 50 063	63	610	5	720,75

6850

Mini Boru Kesici (Bakır ve Alüminyum İçin) Mini Tube Cutter (For Copper and Aluminum)



 Yedek parça sayfa 202
Spare parts page 202

KOD CODE	ÖLÇÜ SIZE	g	□	TL/Ad.
6850 28 0322	1/8" - 5/8"	120	1	94,80

6855

Standart Boru Kesici (Bakır ve Alüminyum İçin) Standard Tube Cutter (For Copper and Aluminum)



 Yedek parça sayfa 202
Spare parts page 202

KOD CODE	ÖLÇÜ SIZE	g	□	TL/Ad.
6855 28 0330	1/8" - 1 1/8"	305	1	131,25

6860

Teleskopik Boru Kesici (Bakır ve Alüminyum İçin) Telescopic Tube Cutter (For Copper and Aluminum)



 Yedek parça sayfa 202
Spare parts page 202

KOD CODE	ÖLÇÜ SIZE	g	□	TL/Ad.
6860 28 0635	1/4" - 1 3/8"	470	1	279,15

6865

Profesyonel Boru Kesici (Çelik İçin) Professional Tube Cutter (For Steel)



 Yedek parça sayfa 202
Spare parts page 202

KOD CODE	ÖLÇÜ SIZE	g	□	TL/Ad.
6865 28 1050	1/8" - 2"	2380	1	704,65





IZELTAS®

ÇEKTİRMELER

PULLERS

Çektirmeler
Pullers

İç Rulman Çektirmeler
Inside Pullers

Rotil Çektirmeler
Balljoint Pullers

Saplama Sökmeler
Stud Inserters and Removers

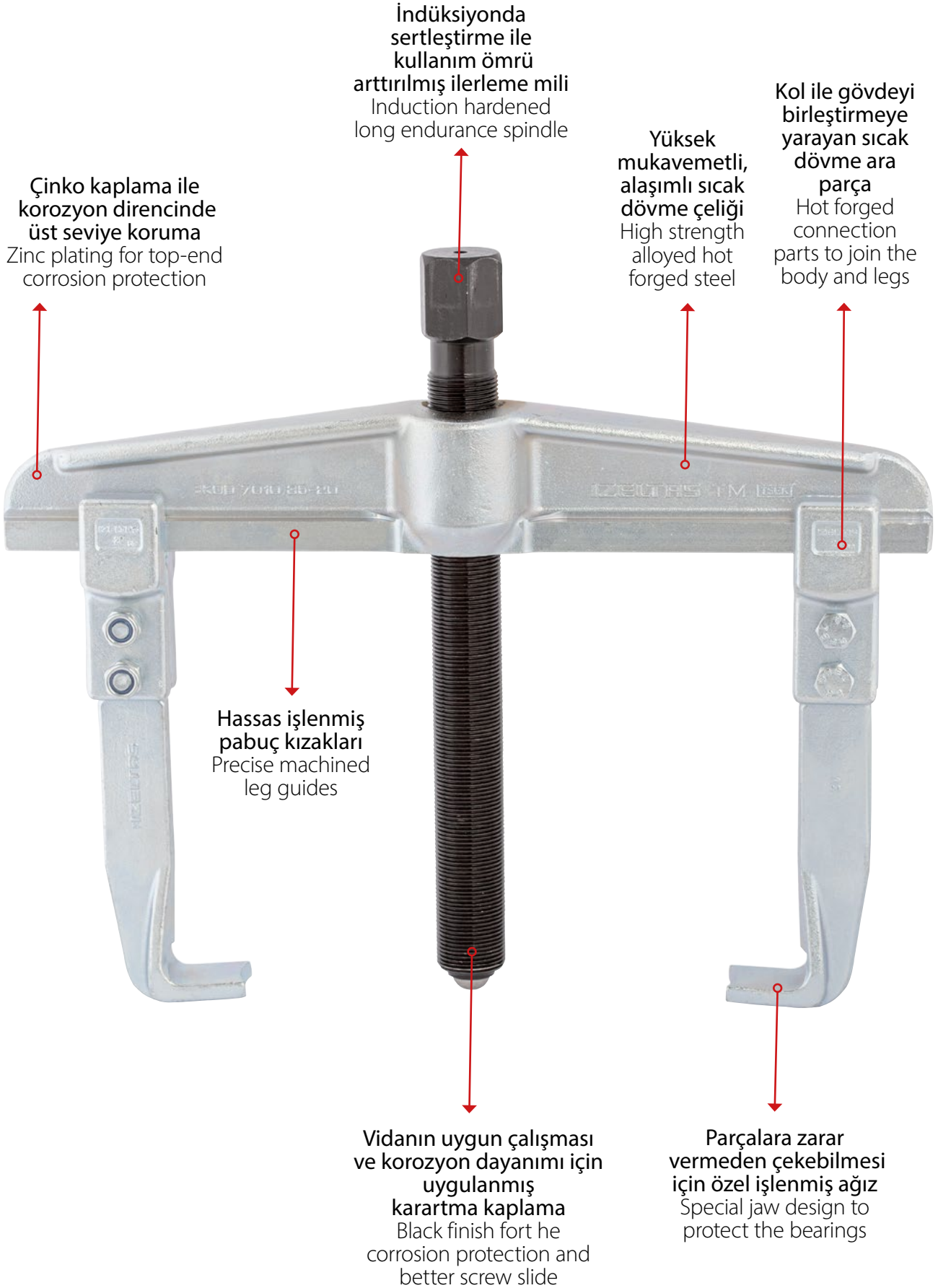

STANDART ÇEKTİRME İKİ KOLLU / STANDARD PULLER TWO ARMS

7010

Standart Çektirme (iki Kollu) Standard Puller (Two Arms)

TSEK

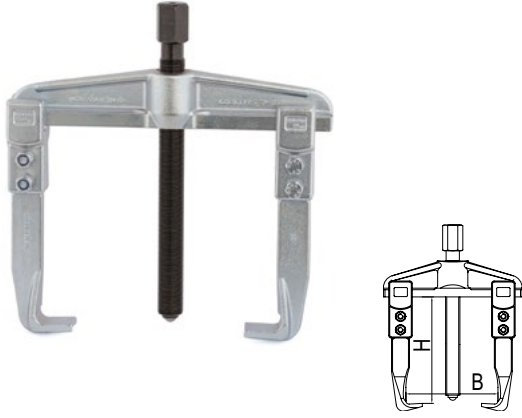

Yedek parça sayfa 203
Spare parts page 203

Krom vanadyum, Çinko kaplı, Kollar sertleştirilmiş,
Mil indüksiyonda sertleştirilmiş
Chrom vanadium, Zinc plated,
Arms hardened, Spindle induction hardened

KOD CODE		B mm	H mm			TL/Ad.
7010 29 0810	8x10	80	100	1080	1	330,50
7010 29 1210	12x10	120	100	1235	1	353,40
7010 29 1615	16x15	160	150	2850	1	602,50
7010 29 2015	20x15	200	150	3060	1	659,05
7010 29 2520	25x20	250	200	4400	1	1138,30
7010 29 3520	35x20	350	200	9900	1	1382,50
7010 29 5220	52x20	520	200	13500	1	2032,30

7010

Standart Çektirme Sehpası (Dolu) Display Frame For Pullers



KOD CODE	İÇERİK CONTENTS			TL/Ad.
7010 00 6105	8x10 - 12x10 - 16x15 20x15 - 25x20	17840	5	3206,60

7020

Standart Çektirme (Üç Kollu) Standard Puller (Three Arms)

TSEK



Yedek parça sayfa 203
Spare parts page 203

Krom vanadyum, Çinko kaplı, Kollar sertleştirilmiş,
Mil indüksiyonda sertleştirilmiş
Chrom vanadium, Zinc plated,
Arms hardened, Spindle induction hardened

KOD CODE		B mm	H mm			TL/Ad.
7020 29 3720	37x20	370	200	13700	1	2551,25
7020 29 5220	52x20	520	200	17815	1	3517,05

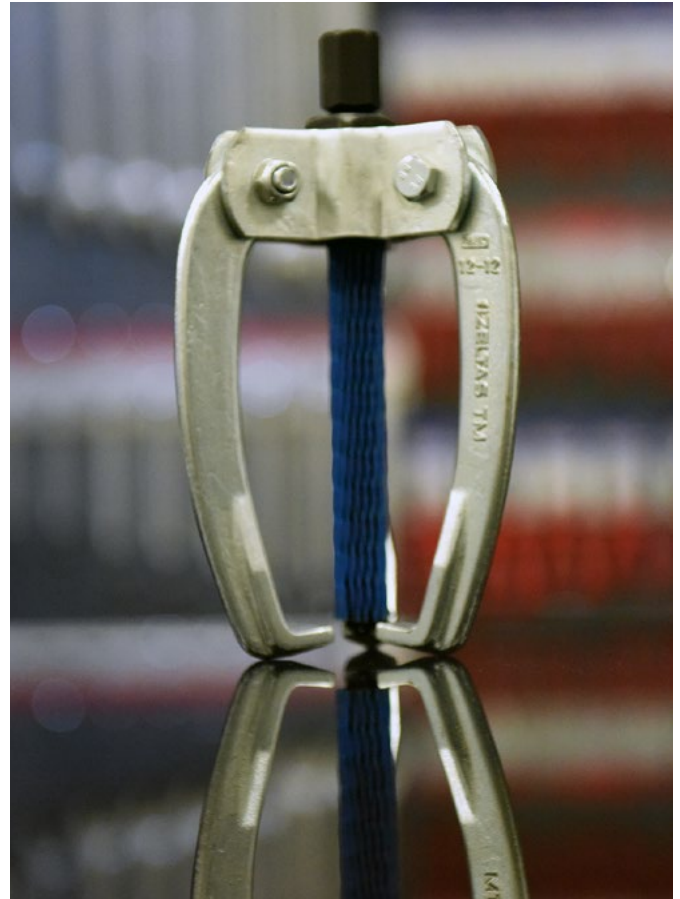

7030

Master Çektirme (İki Kollu)
Master Puller (Two Arms)

TSEK



Yedek parça sayfa 203
Spare parts page 203

Krom vanadyum, Çinko kaplı, Kollar sertleştirilmiş,
Mil indüksiyonda sertleştirilmiş
Chrom vanadium, Zinc plated,
Arms hardened, Spindle induction hardened

KOD CODE		B mm	H mm	 g		TL/Ad.
7030 29 0808	8x8	80	80	545	1	133,05
7030 29 1212	12x12	120	120	1075	1	274,45
7030 29 1616	16x16	160	160	1885	1	413,05
7030 29 2320	23x20	230	200	3240	1	561,60

7040

Master Çektirme (Üç Kollu)
Master Puller (Three Arms)

TSEK



Yedek parça sayfa 203
Spare parts page 203

Krom vanadyum, Çinko kaplı, Kollar sertleştirilmiş,
Mil indüksiyonda sertleştirilmiş
Chrom vanadium, Zinc plated,
Arms hardened, Spindle induction hardened

KOD CODE		B mm	H mm	 g		TL/Ad.
7040 29 0808	8x8	80	80	680	1	254,95
7040 29 1212	12x12	120	120	1355	1	373,15
7040 29 1616	16x16	160	160	2320	1	548,75
7040 29 2320	23x20	230	200	4025	1	738,90

7050

Batarya Çektirme (İki Kollu)
Battery Puller (Two Arms)

TSEK

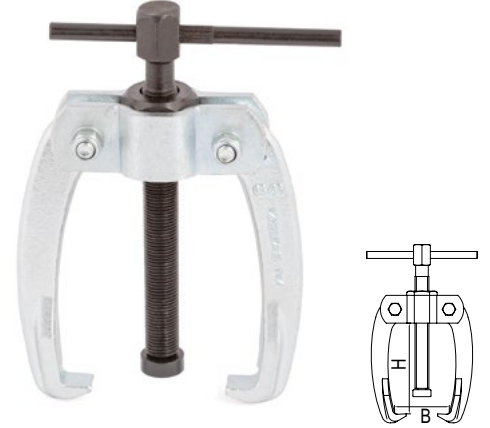

Yedek parça sayfa 203
Spare parts page 203

Krom vanadyum, Çinko kaplı, Kollar sertleştirilmiş,
Mil indüksiyonda sertleştirilmiş
Chrom vanadium, Zinc plated,
Arms hardened, Spindle induction hardened

KOD CODE		B mm	H mm	 g		TL/Ad.
7050 29 0604	6x4	60	40	245	1	148,10
7050 29 0606	6x6	60	60	275	1	152,70
7050 29 0808	8x8	80	80	555	1	160,35

7060

Batarya Çektirme (Üç Kollu)
Battery Puller (Three Arms)

TSEK



Yedek parça sayfa 203
Spare parts page 203

Krom vanadyum, Çinko kaplı, Kollar sertleştirilmiş,
Mil indüksiyonda sertleştirilmiş
Chrom vanadium, Zinc plated,
Arms hardened, Spindle induction hardened

KOD CODE		B mm	H mm	 g		TL/Ad.
7060 29 0604	6x4	60	40	300	1	192,25
7060 29 0606	6x6	60	60	345	1	242,40
7060 29 0808	8x8	80	80	715	1	281,20

7070

S Tipi Çektirme (İki Kollu) S Type Puller (Two Arms)

TSEK

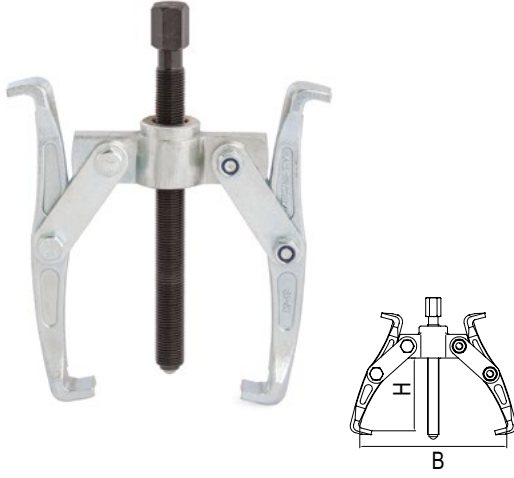

Yedek parça sayfa 203
Spare parts page 203

Krom vanadyum, Çinko kaplı, Kollar sertleştirilmiş,
Mil indüksiyonda sertleştirilmiş
Chrom vanadium, Zinc plated,
Arms hardened, Spindle induction hardened

KOD CODE		B mm	H mm			TL/Ad.
7070 29 2013	20x13	200	130	2420	1	364,75

7090

Üniversal Çektirme (İki Kollu) Universal Puller (Two Arms)

TSEK

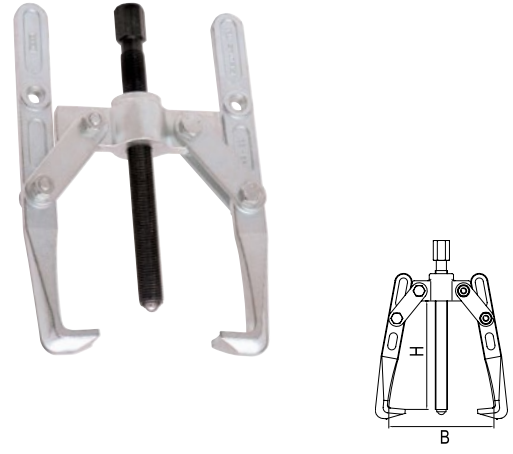

Yedek parça sayfa 203
Spare parts page 203

Krom vanadyum, Çinko kaplı, Kollar sertleştirilmiş,
Mil indüksiyonda sertleştirilmiş
Chrom vanadium, Zinc plated,
Arms hardened, Spindle induction hardened

KOD CODE		B mm	H mm			TL/Ad.
7090 29 2222	22x22	220	220	3085	1	405,30

7080

S Tipi Çektirme (Üç Kollu) S Type Puller (Three Arms)

TSEK

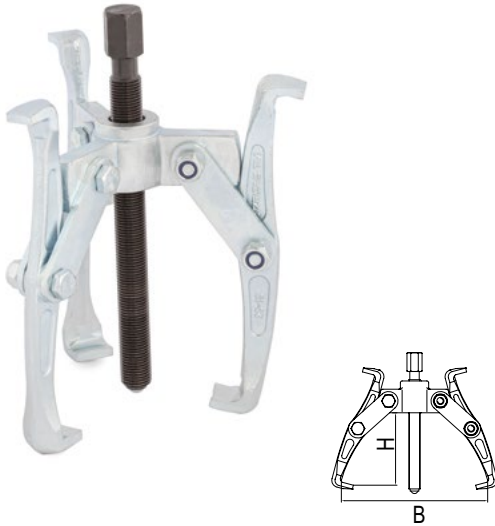

Yedek parça sayfa 203
Spare parts page 203

Krom vanadyum, Çinko kaplı, Kollar sertleştirilmiş,
Mil indüksiyonda sertleştirilmiş
Chrom vanadium, Zinc plated,
Arms hardened, Spindle induction hardened

KOD CODE		B mm	H mm			TL/Ad.
7080 29 2013	20x13	200	130	3250	1	470,40

7100

Üniversal Çektirme (Üç Kollu) Universal Puller (Three Arms)

TSEK



Yedek parça sayfa 203
Spare parts page 203

Krom vanadyum, Çinko kaplı, Kollar sertleştirilmiş,
Mil indüksiyonda sertleştirilmiş
Chrom vanadium, Zinc plated,
Arms hardened, Spindle induction hardened

KOD CODE		B mm	H mm			TL/Ad.
7100 29 2222	22x22	220	220	4125	1	531,30

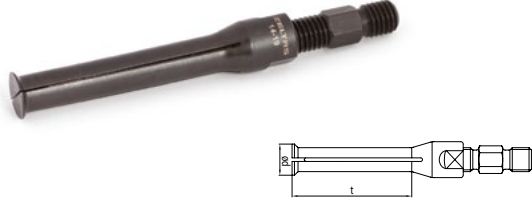
İç Rulman Çektirme Pensleri - Model A
Internal Expansion Puller - Model A

KOD CODE	øD mm	t mm	Kullanılan Kol / For	Adaptör vidası	g	TL/Ad.
7120 29 0507	5 - 7	30	35 - 75	M10	40	1 303,85
7120 29 0709	7 - 9	30	35 - 75	M10	40	1 303,85
7120 29 0912	9 - 12	30	35 - 75	M10	40	1 281,60
7120 29 1013	10 - 13	30	35 - 75	M10	40	1 281,60
7120 29 1317	13 - 17	50	35 - 75	M10	60	1 281,60
7120 29 1419	14 - 19	60	35 - 75	M10	75	1 288,45
7120 29 1621	16 - 21	60	35 - 75	M10	75	1 288,45
7120 29 1823	18 - 23	60	35 - 75	M10	100	1 345,30
7120 29 2025	20 - 25	60	35 - 75	M10	100	1 364,55
7120 29 2530	25 - 30	60	35 - 75	M10	110	1 379,70
7120 29 3037	30 - 37	70	35 - 75 60 - 130	M10	250	1 439,95
7120 29 3542	35 - 42	70	35 - 75 60 - 130	M10	250	1 462,35
7120 29 3845	38 - 45	70	35 - 75 60 - 130	M10	250	1 487,40
7120 29 4350	43 - 50	70	35 - 75 60 - 130	M10	400	1 554,20
★7120 29 4555	45 - 55	100	60 - 210	M16	600	1 587,85
★7120 29 5060	50 - 60	100	60 - 210	M16	700	1 636,10

İç Rulman Çektirme Pensleri - Model B
Internal Expansion Puller - Model B

KOD CODE	øD mm	t mm	Kullanılan Kol / For	Adaptör vidası	g	TL/Ad.
7120 29 2540	25 - 40	45	35 - 75 60 - 130	M10	235	1 615,40

İç Rulman Çektirme Kolları
Arms For Internal Expansion Puller

Krom vanadyum, Çinko kaplı, Kollar sertleştirilmiş,
Mil induksiyonda sertleştirilmiş
Chrom vanadium, Zinc plated,
Arms hardened, Spindle induction hardened

KOD CODE	Kapasite Capacity mm	Kullanılan pensler / For	Adaptör vidası Screw Adapter	g	TL/Ad.
----------	----------------------	--------------------------	------------------------------	---	--------

7120 29 3575	35 - 75	Model A 5 - 7'den 43 - 50'ye Model B 25 - 40	M10	625	1 309,60
--------------	---------	--	-----	-----	----------

7120 29 6013	60 - 130	Model A 30 - 37'den 43 - 50'ye Model B 25 - 40	M10	1000	1 627,30
--------------	----------	--	-----	------	----------

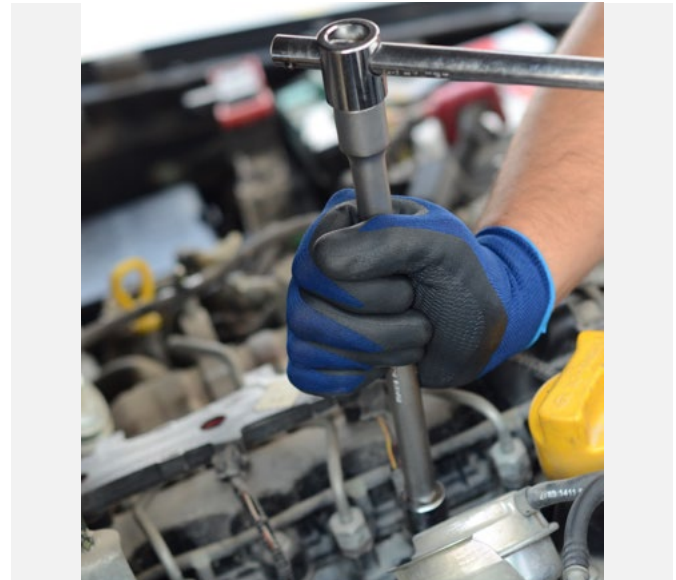

7122

Dış Rulman Çektirme Çeneleri Seperator



Krom vanadyum, Çinko kaplı, Kollar sertleştirilmiş,
Mil indüksiyonda sertleştirilmiş
Chrom vanadium, Zinc plated,
Arms hardened, Spindle induction hardened

KOD CODE	Ø mm	Kullanılan Kollar / For	Adaptör vidası	g	TL/Ad.
7122 29 0560	5 - 60	40 - 115	M12	370	1 469,90
7122 29 1275	12 - 75	40 - 115	M12	635	1 588,70
7122 29 2211	22 - 115	55 - 205	M16	1780	1 919,30
7122 29 2515	25 - 155	90 - 260	M20x1.5	3940	1 1439,05
7122 29 3022	30 - 220	100 - 360	M20x1.5	11000	1 3932,90
7122 29 4028	40 - 280	140 - 435	M24x3	15000	1 8784,25

7122

Dış Rulman Çektirme Kolları Puller Arms For Separator

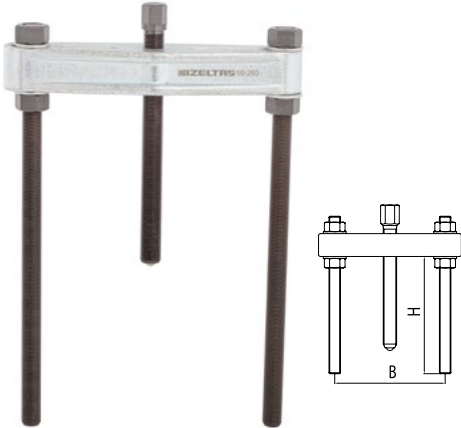

Krom vanadyum, Çinko kaplı, Kollar sertleştirilmiş,
Mil indüksiyonda sertleştirilmiş
Chrom vanadium, Zinc plated,
Arms hardened, Spindle induction hardened

KOD CODE	B mm	H mm	Kullanılan Çene / For	Adaptör vidası	g	TL/Ad.
7122 29 4011	40-115	150	5 - 60 12 - 75	M12	990	1 875,85
7122 29 5520	55-205	210	22 - 115	M16	2700	1 1386,45
7122 29 9026	90-260	315	25 - 155	M20x1.5	4965	1 1962,90
7122 29 1036	100-360	305	30 - 220	M20x1.5	7000	1 4039,65
7122 29 1443	140-435	320	40 - 280	M24x3	11000	1 7895,65

7125

Rotil Çektirme (Çatal) Ball Joint Separator



KOD CODE	B mm	H mm	L mm	g	TL/Ad.
★7125 29 0045	45	26	350	1155	1 570,85

7126

Rotil Çektirme Extractor For Ball Joint

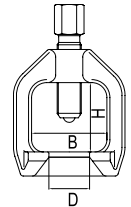

KOD CODE	ØD mm	B mm	H mm	g	TL/Ad.
7126 29 0018	18	40	40	315	1 271,70
7126 29 0025	25	50	50	540	1 372,50
7126 29 0029	29	60	60	915	1 495,50
7126 29 0040	40	80	80	1965	1 699,55
7126 29 0045	45	90	100	2670	1 883,20



IZELTAS®

elta

Anahtarlar
Wrenches

Tornavida ve Allen Anahtarlar
Screwdrivers and Hex Key Wrenches

Lokma Anahtarları
Sockets Wrenches

Keskiler
Chisels

Boru Anahtarları ve Penseler
Pipe Wrenches and Pliers

Makaslar
Shears

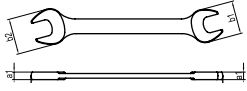

elta

0150
İki Ağız Anahtar (mm)
Double Ended Open Jaw Wrench (mm)

Krom vanadyum, Krom kaplı
Chrom vanadium, Chrom plated

KOD CODE	mm	L mm	a1 mm	b1 mm	b2 mm	g	TL/Ad.
0150 01 0607	6x7	98	3.3	13.5	15.5	10	10,50
0150 01 0809	8x9	108	3.6	17.5	19.5	20	10,65
0150 01 1011	10x11	120	4.1	21.5	23.5	30	11,55
0150 01 1213	12x13	134	4.5	25.5	27.5	40	12,80
0150 01 1415	14x15	150	5	29.65	31.5	60	14,85
0150 01 1617	16x17	163	5.5	33.5	35.5	85	17,20
0150 01 1819	18x19	178	6	37.5	39.5	110	18,45
0150 01 2022	20x22	198	6.5	41.5	45.5	145	20,95
0150 01 2123	21x23	218	6.9	43.5	47.5	175	22,85
0150 01 2426	24x26	236	7.4	49.5	53.5	235	24,50
0150 01 2528	25x28	250	7.8	51.5	57.5	275	30,40
0150 01 2732	27x32	265	8.3	55.5	65.5	345	36,30

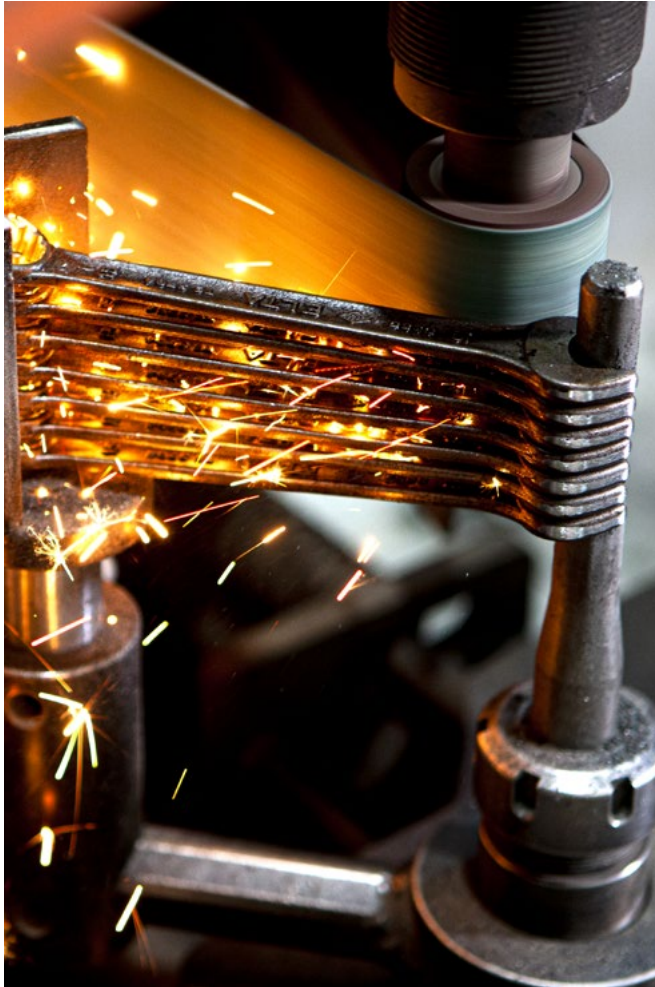
0150
İki Ağız Anahtar Takımı (mm)
Double Ended Open Jaw Wrench Set (mm)

KOD CODE	İÇERİK CONTENTS	g	TL/Ad.
0150 00 2108	6x7 - 8x9 - 10x11 12x13 - 14x15 - 16x17 18x19 - 20x22	560	8 116,95
0150 00 2112	6x7 - 8x9 - 10x11 12x13 - 14x15 - 16x17 18x19 - 20x22 - 21x23 24x26 - 25x28 - 27x32	1590	12 231,00

0350

Kombine Anahtar (mm) Combination Wrench (mm)



TS 3794
TS ISO 7738 Form A
DIN 3113

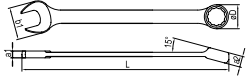

Krom vanadyum, Krom kaplı
Chrom vanadium, Chrom plated

0350

Kombine Anahtar Takımı (mm) Combination Wrench Set (mm)



KOD CODE	mm	L mm	a1 mm	a2 mm	b1 mm	øD mm	g	TL/Ad.	
0350 02 0006	6	95	3.1	5.1	13.5	10	15	10	13,70
0350 02 0007	7	104	3.3	5.5	15.5	11.5	15	10	14,55
0350 02 0008	8	112	3.7	5.9	17.5	13	20	10	15,75
0350 02 0009	9	121	3.9	6.3	19.5	14	25	10	16,30
0350 02 0010	10	130	4.3	6.9	21.5	15.5	30	10	18,35
0350 02 0011	11	138	4.5	7.3	23.5	16.5	35	10	18,90
0350 02 0012	12	146	4.9	7.7	25.5	18	45	10	20,15
0350 02 0013	13	154	5.1	8.1	27.5	19	50	10	20,50
0350 02 0014	14	163	5.5	8.7	29.5	21.5	60	10	22,10
0350 02 0015	15	171	5.7	9.1	31.5	22	70	10	23,70
0350 02 0016	16	180	6.1	9.5	33.5	23	85	10	25,40
0350 02 0017	17	189	6.3	9.9	35.5	25	95	10	27,25
0350 02 0018	18	200	6.7	10.4	37.5	26.5	110	10	30,20
0350 02 0019	19	211	6.9	11	39.5	28	130	10	31,85
0350 02 0020	20	222	7.3	11.4	41.5	29.5	145	10	32,40
0350 02 0021	21	235	7.3	11.4	43.5	31	160	10	37,70
0350 02 0022	22	250	8.1	12.6	45.5	32.5	200	10	43,10
0350 02 0024	24	270	8.7	13.6	49.5	36	250	5	52,60
0350 02 0027	27	300	9.6	14.8	55.5	40	350	5	62,00
0350 02 0030	30	330	10.2	15.8	61.5	44.5	445	5	71,15
0350 02 0032	32	350	10.4	16.2	65.5	47	500	5	74,60

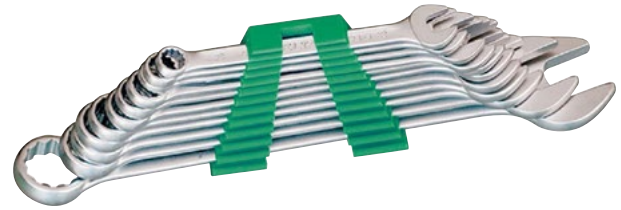

KOD CODE	İÇERİK CONTENTS	g	TL/Ad.	
0350 00 2108	6 - 7 - 8 - 9 - 10 - 13 17 - 19	395	8	158,25
0350 00 2112	8 - 9 - 10 - 11 - 12 13 - 14 - 15 - 16 17 - 19 - 22	855	12	283,35
0350 00 2117	6 - 7 - 8 - 9 - 10 11 - 12 - 13 - 14 15 - 16 - 17 - 18 19 - 20 - 21 - 22	1300	17	411,90
0350 00 2121	6 - 7 - 8 - 9 - 10 11 - 12 - 13 - 14 15 - 16 - 17 - 18 19 - 20 - 21 - 22 24 - 27 - 30 - 32	2810	21	672,25

0450

Yıldız İki Ağız Anahtar (mm) Double Ended Ring Wrench (mm)



TS 3794
TS ISO 10104 Form B
DIN 838

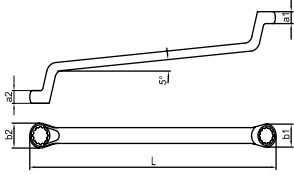

Krom vanadyum, Krom kaplı
Chrom vanadium, Chrom plated

KOD CODE	mm	L mm	a1 mm	a2 mm	b1 mm	b2 mm	g	TL/Ad.
0450 03 0607	6x7	140	4.8	5.2	11	12	45	10 23,65
0450 03 0809	8x9	158	5.4	5.8	13.5	14.5	60	10 23,95
0450 03 1011	10x11	175	6	6.4	16	17.5	90	10 26,60
0450 03 1213	12x13	193	6.6	7.1	19	20	100	10 30,05
0450 03 1415	14x15	210	7.7	8.1	21.5	23.5	140	10 31,55
0450 03 1617	16x17	230	9.2	9.6	25.5	26.5	190	10 35,70
0450 03 1819	18x19	246	10.2	10.6	27.5	29.5	240	10 42,65
0450 03 2022	20x22	280	11.2	11.8	31	34	255	5 46,70
0450 03 2123	21x23	284	11.4	12.2	32.5	35	300	5 53,55
0450 03 2426	24x26	300	12.6	13.2	37	39	335	5 62,35
0450 03 2528	25x28	314	13.6	14.2	38	42	430	5 68,35
0450 03 2732	27x32	329	14.8	15.2	41	49	525	5 75,25

0450

Yıldız İki Ağız Anahtar Takımı (mm) Double Ended Ring Wrench Set (mm)

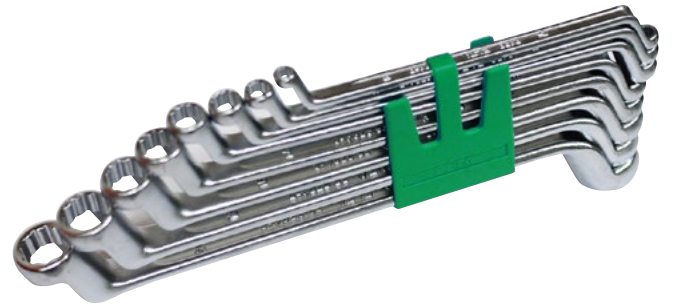

KOD CODE	İÇERİK CONTENTS	g	TL/Ad.
0450 00 2108	6x7 - 8x9 - 10x11 12x13 - 14x15 - 16x17 18x19 - 20x22	1120	8 260,85
0450 00 2112	6x7 - 8x9 - 10x11 12x13 - 14x15 - 16x17 18x19 - 20x22 - 21x23 24x26 - 25x28 - 27x32	2710	12 520,35

0701

Çatal Çakma Anahtar (mm)
Slugging Open Jaw Wrench (mm)

TS 81
DIN 133



Krom vanadyum
Chrom vanadium

KOD CODE	mm	L mm	a1 mm	b mm	g	TL/Ad.
★0701 05 0024	24	160	15	42	280	1 48,05
★0701 05 0042	42	230	19	62	930	1 139,65
★0701 05 0095	95	445	38	140	8160	1 1008,60

0751

Yıldız Çakma Anahtar (mm)
Slugging Ring Wrench (mm)

TS 3794
DIN 7444



Krom vanadyum
Chrom vanadium

KOD CODE	mm	L mm	a1 mm	b mm	g	TL/Ad.
★0751 05 0042	42	225	20	64	730	1 145,10
★0751 05 0070	70	330	32	109	2890	1 409,40
★0751 05 0085	85	360	35	123	3635	1 700,25

0601

Kurbağacık Anahtar
Adjustable Wrench

TS 3796
DIN 3117



Krom vanadyum, Krom kaplı, PVC izoleli
Chrom vanadium, Chrom plated, PVC Insulated

KOD CODE	L mm	L inch	a mm	g	TL/Ad.
0601 01 0008	206	8"	23	240	5 81,75
0601 01 0010	256	10"	28	400	5 123,05
0601 01 0012	306	12"	34	650	5 157,00

1801

Kovan Anahtar İki Ağız (mm)
Double Ended Tubular Socket Wrench (mm)

TS ISO 3793
DIN 896

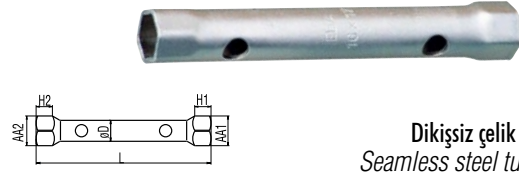

Dikişsiz çelik boru, Çinko kaplı
Seamless steel tube, Zinc plated.

KOD CODE	mm	L mm	AA1 mm	AA2 mm	H1 mm	H2 mm	ø D mm	g	TL/Ad.
★1801 07 0607	6x7	105	8.6	9.6	7	8	8	25	5 18,90
★1801 07 2022	20x22	165	25.4	27.4	16	18	22	220	5 40,40
★1801 07 2123	21x23	165	26.4	28.4	17	19	24	240	5 45,20
★1801 07 2426	24x26	180	30.4	32.4	20	22	26	340	5 58,60
★1801 07 2528	25x28	200	31.4	34.4	21	24	28	400	5 68,95
★1801 07 2732	27x32	200	33.4	38.4	23	26	30	435	5 80,25

1875

Ağır Tip Bijon Anahtarı İki Ağız Uzun
Double Ended Rim Wrench (long)

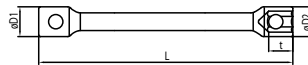

Özel alaşımli çelik, Çinko kaplı
Special steel, Zinc plated

KOD CODE	mm	L mm	t mm	øD1 mm	øD2 mm	g	g	TL/Ad.
★1875 09 2224	22x24	400	34.5	34	36	1060	2310	10 95,10



1115

1/2" Altı Köşe Lokma Anahtar (mm) Socket Wrench 6 Points (mm)

TS ISO 2725
DIN 3124



1/2"

Krom vanadyum, Krom kaplı
Chrom vanadium, Chrom plated

KOD CODE	mm	Ø D1 mm	Ø D2 mm	L mm	L1 mm	g	TL/Ad.
1115 06 0010	10	15.4	22	38	8	60	10
1115 06 0011	11	16.6	22	38	8	60	10
1115 06 0012	12	17.9	22	38	9	60	10
1115 06 0013	13	19	22	38	10	60	10
1115 06 0014	14	20.4	22	38	11	60	10
1115 06 0015	15	21.6	22	38	11	65	10
1115 06 0016	16	22.9	22	38	11	70	10
1115 06 0017	17	24.1	22	38	12	70	10
1115 06 0018	18	25.4	23	38	13	75	10
1115 06 0019	19	26.6	23	38	13	75	10
1115 06 0020	20	28	24	38	13	80	10
1115 06 0021	21	29.2	24	38	13	80	5
1115 06 0022	22	30.4	26	38	15	95	5
1115 06 0023	23	31.2	28	38	15	100	5
1115 06 0024	24	33	28	38	17	115	5
1115 06 0026	26	34	30	42	17	130	5
1115 06 0027	27	36.6	30	42	19	140	5
1115 06 0028	28	37.5	30	42	20	160	5
1115 06 0030	30	40	32	44	21	175	5
1115 06 0032	32	43	34	44	23	180	5

1514

1/2" T Kol Adaptörü Adapter



1/2"

Krom vanadyum, Krom kaplı
Chrom vanadium, Chrom plated

KOD CODE	inch	g	TL/Ad.
1514 06 6250	3/8"Fx1/2"M	90	5
			36,30

1514

1/2" Ara Kol Extension Bar

TS ISO 3316
DIN 3123



1/2"

Krom vanadyum, Krom kaplı
Chrom vanadium, Chrom plated

KOD CODE	L mm	g	TL/Ad.
1514 06 4125	125	220	5
1514 06 4250	250	425	5

1514

1/2" T Kol Sliding T - Handle

TS ISO 3315
DIN 3122



1/2"

Krom vanadyum, Krom kaplı
Chrom vanadium, Chrom plated

KOD CODE	L mm	g	TL/Ad.
1514 06 4025	250	370	5
			63,45

1514

1/2" Mafsal Universal Joint

TS ISO 3316
DIN 3123



1/2"

Krom vanadyum, Krom kaplı
Chrom vanadium, Chrom plated

KOD CODE	L mm	g	TL/Ad.
1514 06 4065	65	140	5
			47,55

1514

1/2" U Kol
Speed brace with revolving rubber handle

TS ISO 3315
DIN 3122



1/2"

Krom vanadyum, Krom kaplı
Chrom vanadium, Chrom plated

KOD CODE	L mm	g	TL/Ad.
★1514 06 4420	420	510	5 92,15

1514

1/2" Cırcır Kolu
Ratchet Handle

TS ISO 3315
DIN 3122



1/2"

Krom vanadyum, Krom kaplı
Chrom vanadium, Chrom plated

KOD CODE	L mm	g	TL/Ad.
1514 06 5250	250	585	5 135,15

1115

1/2" Altı Köşe Lokma Anahtar Takımı (17 Parça, mm)
Socket Wrench Set 6 Points (17 pcs, mm)



1/2"

KOD CODE	LOKMALAR Sockets	AVADANLIKLAR Accessories	g	TL/Ad.
1115 00 2017		1/2" Cırcır Kolu Ratchet Handle	2650	17 543,75
		1/2" T Kol Adaptör Sliding T Handle Adapter		
	10 - 11 - 12 13 - 14 - 15 17 - 19 - 22 24 - 27 - 30 32	1/2" Mafsal Universal Joint		
		1/2" Ara Kol Extension Bar 250 mm		

1115

1/2" Altı Köşe Lokma Anahtar Takımı (18 Parça, mm)
Socket Wrench Set 6 Points (18 pcs, mm)



1/2"

KOD CODE	LOKMALAR Sockets	AVADANLIKLAR Accessories	g	TL/Ad.
★1115 00 6018		1/2" Cırcır Kolu Ratchet Handle	4775	18 663,05
		1/2" U Kol Speed Brace with Revolving Rubber Handle		
	10 - 11 - 12 13 - 14 - 15 17 - 19 - 22 24 - 27 - 30 32	1/2" T Kol Sliding T Handle		
		1/2" Mafsal Universal Joint		
		1/2" Ara Kol Extension Bar 250 mm		

1115

1/2" Altı Köşe Lokma Anahtar Takımı (24 Parça, mm)
Socket Wrench Set 6 Points (24 pcs, mm)



1/2"

KOD CODE	LOKMALAR Sockets	AVADANLIKLAR Accessories	g	TL/Ad.
1115 00 2024		1/2" Cırcır Kolu Ratchet Handle	3485	24 706,35
		1/2" Mafsal Universal Joint		
	10 - 11 - 12 13 - 14 - 15 16 - 17 - 18 19 - 21 - 22 23 - 24 - 26 27 - 28 - 30 - 32	1/2" T Kol Adaptör Sliding T Handle Adapter		
		1/2" Ara Kol Extension Bar 125 mm		
		1/2" Ara Kol Extension Bar 250 mm		

1121

3/4" Altı Köşe Lokma Anahtar (mm) Socket Wrench 6 Points (mm)

TS ISO 2725
DIN 3124

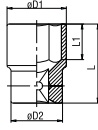

3/4"

Krom vanadyum, Krom kaplı
Chrom vanadium, Chrom plated

KOD CODE	mm	Ø D1 mm	Ø D2 mm	L mm	L1 mm	g	TL/Ad.
★1121 06 0022	22	33	36	52	16	220	5 31,45
★1121 06 0024	24	35	36	52	16	220	5 31,45
★1121 06 0027	27	38	36	52	19	235	5 32,10
★1121 06 0030	30	42	38	54	21	295	5 35,65
★1121 06 0034	34	47	42	58	24	400	5 53,75
★1121 06 0041	41	56	45	64	29	570	5 76,65
★1121 06 0046	46	62	48	68	33	725	1 82,80
★1121 06 0050	50	68	48	72	34	905	1 100,75
★1121 06 0055	55	76	48	76	37	1095	1 120,00
★1121 06 0060	60	80	48	78	38	1275	1 139,35

1521

3/4" Ara Kol Extension Bar

TS ISO 1174
DIN 3123



3/4"

Krom vanadyum, Krom kaplı
Chrom vanadium, Chrom plated

KOD CODE	L mm	g	TL/Ad.
★1521 06 4200	200	730	5 117,90
★1521 06 4400	400	1380	5 209,45

1521

3/4" T Kol Sliding T - Handle

TS ISO 3315
DIN 3122



3/4"

Krom vanadyum, Krom kaplı
Chrom vanadium, Chrom plated

KOD CODE	L mm	g	TL/Ad.
★1521 06 4500	500	1490	5 225,25

1115

1/2" Altı Köşe Havalı Lokma Anahtar (mm) Impact Socket Wrench 6 Points (mm)

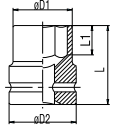

1/2"

Krom molibden, Fosfat kaplamalı
Chrom molybdenum, Phosphate finish

KOD CODE	mm	Ø D1 mm	Ø D2 mm	L mm	g	TL/Ad.
★1115 06 7010	10	17	25	38	70	10 14,05
★1115 06 7011	11	18	25	38	70	10 14,05
★1115 06 7012	12	19	25	38	70	10 14,05
★1115 06 7013	13	20	25	38	70	10 14,05
★1115 06 7014	14	22	25	38	75	10 14,05
★1115 06 7015	15	23	30	38	110	10 15,95
★1115 06 7016	16	24	30	38	110	10 15,95
★1115 06 7017	17	26	30	38	115	10 18,40
★1115 06 7018	18	27	30	38	115	10 18,40
★1115 06 7019	19	28	30	38	120	10 18,40
★1115 06 7021	21	30	30	40	125	5 21,05
★1115 06 7022	22	32	30	40	145	5 21,05
★1115 06 7024	24	34	30	42	150	5 24,55
★1115 06 7027	27	38	30	44	175	5 28,35

1514

1/2" Havalı Lokma Ara Kol Impact Socket Extension Bar



1/2"

Krom molibden, Fosfat kaplamalı
Chrom molybdenum, Phosphate finish

KOD CODE	L mm	g	TL/Ad.
★1514 06 7125	125	275	5 41,35
★1514 06 7250	250	450	5 56,95

Havalı aletler ile kullanmayınız / Do not use with power-tools

1121

3/4" Altı Köşe Havalı Lokma Anahtar (mm) Impact Socket Wrench 6 Points (mm)

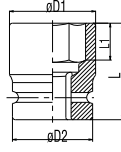

3/4"

Krom molibden, Fosfat kaplamalı
Chrom molybdenum, Phosphate finish

KOD CODE	Ø mm	Ø D1 mm	Ø D2 mm	L mm	L1 mm	g	TL/Ad.
★1121 06 7019	19	32	44	50	12	315	5 42,50
★1121 06 7022	22	36	44	50	15	345	5 42,50
★1121 06 7024	24	38	44	50	16	350	1 42,50
★1121 06 7027	27	42	44	53	17	380	1 43,90
★1121 06 7030	30	46	44	53	20	410	1 45,65
★1121 06 7034	34	51	44	57	22	490	1 47,10
★1121 06 7041	41	59	44	58	24	580	1 81,65
★1121 06 7046	46	66	44	62	24	720	1 81,65

1521

3/4" Havalı Lokma Ara Kol Impact Socket Extension Bar



3/4"

Krom molibden, Fosfat kaplamalı
Chrom molybdenum, Phosphate finish

KOD CODE	L mm	g	TL/Ad.
★1521 06 7175	175	865	5 81,05
★1521 06 7250	250	1155	5 104,45
★1521 06 7330	330	1425	5 134,00

1521

3/4" Havalı Lokma Mafsal Impact Socket Universal Joint



3/4"

Krom molibden, Fosfat kaplamalı
Chrom molybdenum, Phosphate finish

KOD CODE	L mm	g	TL/Ad.
★1521 06 7108	108	735	1 141,00

2203

Maşalı Boru Anahtarı (85°) Pipe Wrench (85°)

DIN 5234



Krom vanadyum, Dişler induksiyonda sertleştirilmiş, Elektrostatik boyanmış
Chrom vanadium, Teeth induction hardened, Electrostatically painted

KOD CODE	L mm	mm	inch	g	TL/Ad.
2203 10 0010	325	37	1"	760	1 126,20
2203 10 0015	430	43	1 1/2"	1360	1 194,00
2203 10 0020	585	49	2"	2350	1 289,25
★2203 10 0030	690	55	3"	3200	1 443,30

2401

Fort Pense Waterpump Pliers

TS 60
TS ISO 8976
DIN 8976



Krom vanadyum, Nikel kaplı, PVC izoleli
Chrom vanadium, Nickel plated, PVC Insulated

KOD CODE	L mm	L inch	mm	g	TL/Ad.
2401 11 0240	240	9 1/2"	35	375	5 125,20

2509

Ayarlı Pense Grip

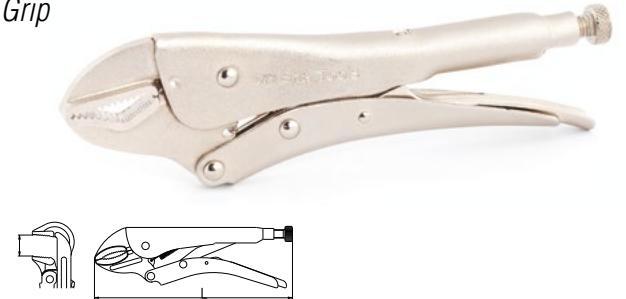

Çeneler krom vanadyum çeliğinden dövülmüştür, Nikel kaplama,
Kullanım sahası: Yuvarlak ve düz malzemeler
Jaws Chrom vanadium forged, Nickel plated
Application field : Flat and round materials

KOD CODE	L mm	L inch	mm	g	TL/Ad.
2509 11 0225	225	9"	30	470	5 118,85

3021

Kombine Pense Opak Seri Combination Pliers

TS 60
DIN ISO 5746



Özel alaşımli çelik, Kesici ağızlar induksiyonda sertleştirilmiş, Krom kaplı, PVC saplı
Special steel, Cutters induction hardened, Chrom plated, PVC handle

KOD CODE	L mm	L inch	g	□	TL/Ad.
3021 12 1160	160	6 1/4"	200	5	67,00
3021 12 1180	180	7 1/8"	250	5	82,00
3021 12 1200	200	8"	310	5	99,95

3221

Kargaburun Düz Uçlu Opak Seri Long Nose Pliers (Flat)

TS 60
TS ISO 5745



Özel alaşımli çelik, Kesici ağızlar induksiyonda sertleştirilmiş, Krom kaplı, PVC saplı
Special steel, Cutters induction hardened, Chrom plated, PVC handle

KOD CODE	L mm	L inch	g	□	TL/Ad.
3221 13 1160	160	6 1/4"	145	5	72,70
3221 13 1200	200	8"	190	5	83,25

3701

Yan Keski Opak Seri Side Cutting Pliers

TS 60
TS ISO 5749
DIN 5749



Özel alaşımli çelik, Kesici ağızlar induksiyonda sertleştirilmiş, Krom kaplı, PVC saplı
Special steel, Cutters induction hardened, Chrom plated, PVC handle

KOD CODE	L mm	L inch	g	□	TL/Ad.
3701 16 1140	140	5 1/2"	160	5	61,70
3701 16 1160	160	6 1/4"	220	5	72,50

3303

Dış Segman Pense (Yaylı Düz) Circlip Pliers, External (Flat)

TS 60



Krom vanadyum, Krom kaplı, PVC izoleli
Chrom vanadium, Chrom plated, PVC Insulated

KOD CODE	L mm	□	g	□	TL/Ad.
★3303 12 0140	140	10 - 25	90	5	71,70
★3303 12 0180	180	19 - 60	165	5	75,55
★3303 12 0220	220	40 - 100	315	5	90,40

3304

Dış Segman Pense (Yaylı Eğri) Circlip Pliers, External (Bent)

TS 60



Krom vanadyum, Krom kaplı, PVC izoleli
Chrom vanadium, Chrom plated, PVC Insulated

KOD CODE	L mm	□	g	□	TL/Ad.
★3304 12 0125	125	10 - 25	90	5	80,00
★3304 12 0200	200	40 - 100	315	5	100,45

3323

İç Segman Pense (Yaysız Düz) Circlip Pliers Internal (Flat)

TS 60

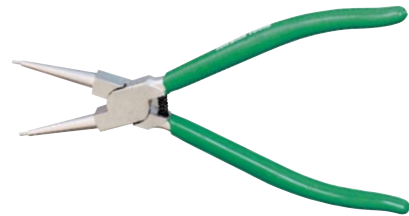

Krom vanadyum, Krom kaplı, PVC izoleli
Chrom vanadium, Chrom plated, PVC Insulated

KOD CODE	L mm	□	g	□	TL/Ad.
★3323 12 0140	140	8 - 25	90	5	65,90
★3323 12 0180	180	19 - 60	140	5	69,50
★3323 12 0230	230	40 - 100	300	5	98,00

3324

İç Segman Pense (Yaysız Eğri) Circlip Pliers Internal (Bent)

TS 60

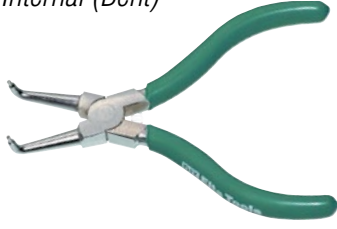

Krom vanadyum, Krom kaplı, PVC izoleli
Chrom vanadium, Chrom plated, PVC Insulated

KOD CODE	L mm	⌀	g	□	TL/Ad.
★3324 12 0130	130	8 - 25	90	5	70,80
★3324 12 0170	170	19 - 60	140	5	74,60
★3324 12 0210	210	40 - 100	300	5	89,00

3801

Kerpeten Carpenter Pincers

TS 60
TS ISO 9243
DIN ISO 9243



Özel alaşımlı çelik, Kesici ağızlar indüksiyonda sertleştirilmiş,
Vernikli, PVC izoleli

Special steel, Cutters induction hardened, Lacquered, PVC Insulated

KOD CODE	L mm	L inch	g	□	TL/Ad.
3801 15 0160	160	6 1/4"	235	5	68,00
3801 15 0180	180	7 1/8"	245	5	73,45
3801 15 0200	200	8"	390	5	88,85

3832

Betoncu Kerpeteni Tower Pincers

TS 60
TS ISO 9242
DIN ISO 9242



Özel alaşımlı çelik, Kesici ağızlar indüksiyonda sertleştirilmiş,
Vernikli, PVC izoleli

Special steel, Cutters induction hardened, Lacquered, PVC insulated

KOD CODE	L mm	L inch	g	□	TL/Ad.
3832 15 0225	225	9"	335	5	82,00
3832 15 0250	250	10"	415	5	93,45
3832 15 0280	280	11"	475	5	113,35

4150

Opak Seri Düz Uçlu Tornavida Screwdriver, Opak, Flat

TS ISO 2380 - 1
DIN ISO 2380-1

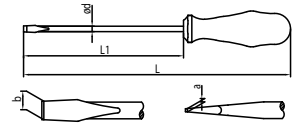

Krom vanadyum, Krom kaplı, PP saplı
Chrom vanadium, Chrom plated, PP handle

KOD CODE	ØDxL1 mm	⊖		L mm	g	□	TL/Ad.
		a mm	b mm				
4150 17 0380	3x80	0.5	3	150	20	10	11,45
4150 17 0480	4x80	0.8	4	170	30	10	13,20
4150 17 4100	4x100	0.8	4	190	40	10	14,10
4150 17 5100	5x100	1.0	5.5	200	55	10	17,00
4150 17 5125	5x125	1.0	5.5	225	60	10	19,60
4150 17 6100	6x100	1.2	6.5	200	70	10	17,65
4150 17 6125	6x125	1.2	6.5	225	75	10	20,10
4150 17 6150	6x150	1.2	6.5	250	80	10	22,15
★4150 17 7125	7x125	1.2	8	260	110	10	19,35
4150 17 7150	7x150	1.2	8	260	110	10	25,95
4150 17 8150	8x150	1.6	10	260	130	10	28,10
4150 17 8175	8x175	1.6	10	285	135	10	31,50

4170

Opak Seri Yıldız Uçlu Tornavida Screwdriver, Opak Phillips

TS 59 - 5 ISO 8764
DIN ISO 8764

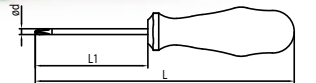

Krom vanadyum, Krom kaplı, PP saplı
Chrom vanadium, Chrom plated, PP handle

KOD CODE	ØDxL1 mm	+	L mm	g	□	TL/Ad.
4170 18 0360	3x60	Ph0	130	15	10	12,95
4170 18 4580	4.5x80	Ph1	170	45	10	17,50
4170 18 6100	6x100	Ph2	200	70	10	21,05
4170 18 8150	8x150	Ph3	260	130	10	39,80

(★) İşaretli olan ürünler stoklarla sınırlıdır.
Limited with stocks.

4150

Opak Seri Tornavida Seti (6 parça) Screwdriver Set, Opak (6 Pcs)



KOD CODE	İÇERİK CONTENTS	g	TL/Ad.
4150 00 8106	4x80 - 5x100 - 6x125	545	6
	7x150		
	Düz uçlu / Flat		
	4.5x80 - 6x100		
	Yıldız uçlu / Phillips		

4160

Ergonom Seri Düz Uçlu Tornavida Screwdriver, Ergonom, Flat

TS ISO 2380-1
DIN ISO 2380-1

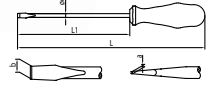

Krom vanadyum, Krom kaplı, Ucu siyah oksit, İki komponent saplı
Chrom vanadium, Chrom plated and black tips,
Two component handle

KOD CODE	øDxL1 mm	a mm		L mm	g	TL/Ad.
		a mm	b mm			
★4160 17 0380	3x80	0.5	3	160	25	10,05
★4160 17 0480	4x80	0.8	4	170	40	11,35
★4160 17 0580	5x80	1.0	5.5	180	45	12,65
★4160 17 4100	4x100	0.8	4	190	45	12,50
★4160 17 5100	5x100	1.0	5.5	200	60	15,10
★4160 17 5125	5x125	1.0	5.5	225	65	17,45
★4160 17 6150	6x150	1.2	6.5	250	90	19,55
★4160 17 7150	7x150	1.2	8	260	130	23,05

4150

Opak Seri Tornavida Seti (7 parça) Screwdriver Set, Opak (7 Pcs)



KOD CODE	İÇERİK CONTENTS	g	TL/Ad.
4150 00 8107	3x80 - 4x100 - 5x125	605	7
	6x150 - 8x175		
	Düz uçlu / Flat		
	4.5x80 - 6x100		
	Yıldız uçlu / Phillips		

4180

Ergonom Seri Yıldız Uçlu Tornavida Screwdriver, Ergonom, Phillips

TS 59 -5 ISO 8764-1
DIN ISO 8764

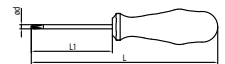

Krom vanadyum, Krom kaplı, Ucu siyah oksit, İki komponent saplı
Chrom vanadium, Chrom plated and black tips,
Two component handle.

KOD CODE	øDxL1 mm	+	L mm	g	TL/Ad.
★4180 18 0360	3x60	Ph0	140	25	11,65
★4180 18 4510	4.5x100	Ph1	190	60	17,05
★4180 18 8150	8x150	Ph3	260	130	34,85

4170

Değişken Uçlu Tornavida Screwdriver - Reversible

TSEK



Krom vanadyum, Krom kaplı, PP saplı
Chrom vanadium, Chrom plated, PP handle

KOD CODE	ØDxL1 mm	axb mm	+	L mm	g	TL/Ad.
4170 17 0680	6x80	1.2x6	Ph2	180	60	10, 26,40

4501

Elektronikçi Tip (Klemens) Düz Uçlu Tornavida Electronic Screwdriver, Flat



Krom vanadyum, Krom kaplı, Ucu siyah oksid, PP saplı
Chrom vanadium, Chrom plated and black tips, PP handle

KOD CODE	ØDxL1 mm	-		L mm	g	TL/Ad.
		a mm	b mm			
★4501 17 3150	3x150	0.5	3	230	20	10, 15,10
★4501 17 4150	4x150	0.8	4	230	25	10, 16,05

4552

Elektrik Kontrol Kalemii Voltage Tester

TS 13108

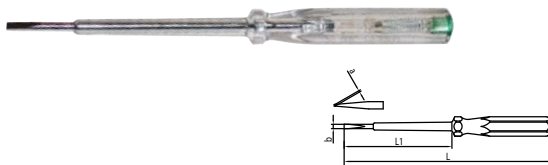

Krom vanadyum, Krom kaplı, Selüloz asetat saplı
Chrom vanadium, Chrom plated, Cellulose acetate handle

KOD CODE	L mm	-		L1 mm	g	TL/Ad.
		a mm	b mm			
★4552 17 0190	190	0.8	4	100	35	10, 17,05

4771

Lokma Uçlu Tornavida (mm) Nut Spinner (mm)

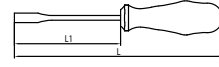

Krom vanadyum, Krom kaplı, PP saplı
Chrom vanadium, Chrom plated, PP handle

KOD CODE	mm	L mm	L1 mm	g	TL/Ad.
★4771 19 0090	9	235	125	115	10, 31,40
★4771 19 0110	11	235	125	135	10, 34,65

4811

Düz Bits Slotted Bit



KOD CODE	-	L mm	g	TL/Ad.
★4811 20 0645	0.6x4.5	25	5	10, 2,00
★4811 20 0855	0.8x5.5	25	5	10, 2,00
★4811 20 1265	1.2x6.5	25	5	10, 2,00
★4811 20 5645	0.6x4.5	50	10	10, 3,05
★4811 20 5855	0.8x5.5	50	10	10, 3,05
★4811 20 5265	1.2x6.5	50	10	10, 3,05

4821

Yıldız Bits Phillips Bit



KOD CODE	+	L mm	g	TL/Ad.
★4821 21 0001	Ph1	25	5	10, 1,80
★4821 21 0002	Ph2	25	5	10, 1,80
★4821 21 0003	Ph3	25	5	10, 1,80
★4821 21 0011	Ph1	50	10	10, 3,70
★4821 21 0013	Ph3	50	10	10, 3,70

4831

Torx® Bits Torx® Bit



KOD CODE	★	L mm	g	TL/Ad.
★4831 21 0025	T25	25	5	10, 2,50
★4831 21 0027	T27	25	5	10, 2,50
★4831 21 0030	T30	25	5	10, 2,50
★4831 21 0040	T40	25	5	10, 2,50
★4831 21 0125	T25	50	10	10, 4,20
★4831 21 0127	T27	50	10	10, 4,20
★4831 21 0140	T40	50	10	10, 4,20

(★) İşaretili olan ürünler stoklarla sınırlıdır.
Limited with stocks.

4908

Allen Anahtar Altı Köşe (mm) Hex Key Wrench (mm)

TS ISO 2936
DIN ISO 2936

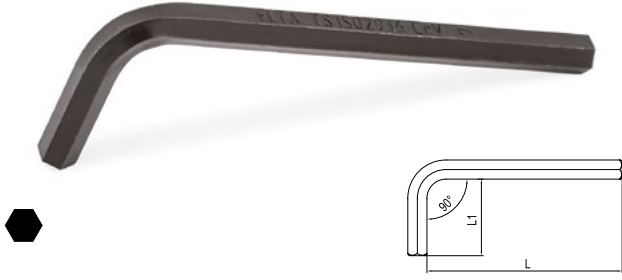

14-17-19mm ölçüler Krom kaplı
14-17-19 size chrome plated

Krom vanadyum, Siyah Oksit Kaplı
Chrom vanadium, Black finish

KOD CODE	mm	L mm	L1 mm	g	TL/Ad.	
4908 22 0015	1.5	45	14	1.5	10	1,65
4908 22 0020	2	50	16	2	10	2,05
4908 22 0025	2.5	56	18	4	10	2,50
4908 22 0030	3	63	20	6	10	2,85
4908 22 0035	3.5	66	22	8	10	3,05
4908 22 0040	4	70	25	10	10	3,55
4908 22 0050	5	80	28	20	10	3,70
4908 22 0060	6	90	32	30	10	4,80
4908 22 0070	7	95	36	40	10	6,80
4908 22 0080	8	100	36	55	10	7,90
4908 22 0090	9	105	38	75	10	11,15
4908 22 0100	10	112	40	100	10	12,00
4908 22 0120	12	125	45	160	10	17,55
★4908 22 0140	14	137	53	250	5	26,30
★4908 22 0170	17	155	60	425	5	46,25
★4908 22 0190	19	174	67	610	5	60,35

4908

Allen Anahtar Takım Altı Köşe (mm) Hex Key Wrench Set (mm)

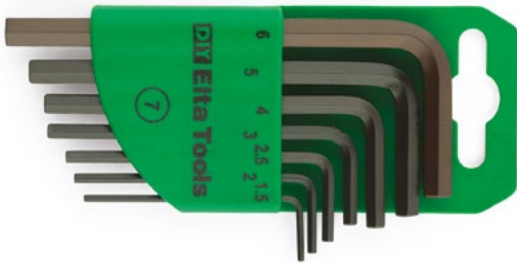

KOD CODE	İÇERİK CONTENTS	g	TL/Ad.	
4908 00 3107	1.5 - 2 - 2.5 - 3 - 4 - 5 - 6	80	7	21,10
4908 00 3109	1.5 - 2 - 2.5 - 3 - 4 5 - 6 - 8 - 10	235	9	41,00
4908 00 3110	1.5 - 2 - 2.5 - 3 - 4 - 5 6 - 8 - 10 - 12	395	10	58,55

4911

Torx® Allen Anahtar Torx® Key Wrench

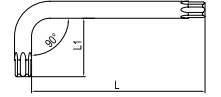

Krom vanadyum, Çinko kaplı
Chrom vanadium, Zinc Plated

KOD CODE	★	L mm	L1 mm	g	TL/Ad.	
★4911 22 0006	T6	42	16	2	10	8,90
★4911 22 0007	T7	48	16	2	10	8,90
★4911 22 0008	T8	48	16	3	10	8,90
★4911 22 0009	T9	48	16	3	10	9,80
★4911 22 0015	T15	54	18	5	10	10,10
★4911 22 0020	T20	57	19	5	10	10,55
★4911 22 0025	T25	60	20	10	10	10,55
★4911 22 0027	T27	64	21	15	10	10,55
★4911 22 0030	T30	70	24	20	10	11,35
★4911 22 0040	T40	76	26	30	10	12,00
★4911 22 0045	T45	83	29	40	10	14,75
★4911 22 0050	T50	95	32	60	10	16,80
★4911 22 0055	T55	108	35	125	10	23,40
★4911 22 0060	T60	120	38	185	10	32,30

4915

Kaset Allen Anahtar Takımı (6 Parça, mm) Hex Key Wrench Folding Set (6 Pcs, mm)



Krom vanadyum, Siyah oksit kaplı
Chrom vanadium, Black finish

KOD CODE	İÇERİK CONTENTS	g	TL/Ad.	
4915 00 6106	2.5 - 3 - 4 - 5 - 6 - 8	175	1	91,00

4922

T Tipi Allen Anahtar (mm) Hex Key Wrench T - Handle (mm)

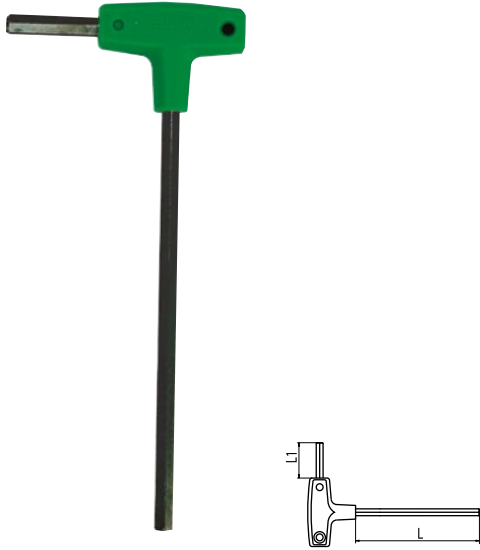

Krom vanadyum, Siyah Oksit Kaplı, PP saplı
Chrom vanadium, Black finish, PP handle

KOD CODE	mm	L mm	L1 mm	g	TL/Ad.	
4922 22 0025	2.5	110	14	15	5	21,15
4922 22 0030	3	125	18	20	5	21,25
4922 22 0040	4	140	22	30	5	21,45
4922 22 0050	5	155	26	55	5	24,35
4922 22 0060	6	170	30	75	5	26,75
4922 22 0070	7	185	34	115	5	27,65
4922 22 0080	8	200	38	150	5	33,35
4922 22 0100	10	220	48	270	5	58,25

4922

T Tipi Allen Anahtar Takımı (8 Parça, mm) Hex Key Wrench T - Handle Set (8 Pcs, mm)



KOD CODE	İÇERİK CONTENTS	g	TL/Ad.	
4922 00 8108	2.5 - 3 - 4 - 5 6 - 7 - 8 - 10	730	8	234,20

5011

Iskarpela (Düz) Wood Chisel

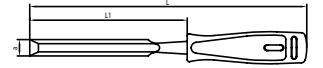

Özel alaşımlı çelik, Uç induksiyonda sertleştirilmiş, PP Saplı
Special steel, induction hardened tips, PP Handle

KOD CODE	a mm	L mm	L1 mm	g	TL/Ad.	
5011 23 0006	6	245	120	105	5	37,25
5011 23 0008	8	245	122	125	5	39,40
5011 23 0010	10	245	124	140	5	41,70
5011 23 0012	12	245	126	140	5	45,75
5011 23 0014	14	245	128	145	5	47,35
5011 23 0016	16	255	130	165	5	50,55
5011 23 0018	18	255	132	165	5	54,90
5011 23 0020	20	255	134	165	5	60,90
5011 23 0022	22	255	136	180	5	66,20
5011 23 0024	24	255	138	205	5	71,35
5011 23 0026	26	255	140	205	5	74,05
5011 23 0030	30	260	150	205	5	78,95

5501

Düz Keski Flat Cold Chisel

TS 492
DIN ISO 6450



Krom vanadyum, Elektrostatik boyanmış
Chrom vanadium, Electrostatically painted

KOD CODE	L mm	a	mm	g	TL/Ad.	
★5501 23 0100	100	10	10	50	5	24,20
★5501 23 0125	125	10	10	70	5	27,45
★5501 23 0150	150	14	12	140	5	36,25
★5501 23 0175	175	18	12	170	5	40,80
★5501 23 0200	200	20	16	295	5	52,15
★5501 23 0250	250	22	16	370	5	64,10
★5501 23 0300	300	24	20	645	5	102,70

5521

Tırnak Keski Cross Cut Chisel

TS 492/1



Krom vanadyum, Elektrostatik boyanmış
Chrom vanadium, Electrostatically painted

KOD CODE	L mm	a mm	mm	g	TL/Ad.
★5521 23 0125	125	5	10	70	10 23,65
★5521 23 0150	150	6	12	110	10 31,55

5546

Konik Pim Zımba Drift Punch

TS 2338
DIN 6448

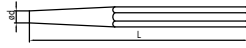

Krom vanadyum, Elektrostatik boyanmış
Chrom vanadium, Electrostatically painted

KOD CODE	L mm	L inch	ØD mm	mm	g	TL/Ad.
★5546 24 0002	120	4 3/4"	2	10	55	10 18,70
★5546 24 0003	120	4 3/4"	3	10	60	10 18,70
★5546 24 0004	120	4 3/4"	4	10	60	10 18,70
★5546 24 0005	120	4 3/4"	5	10	65	10 18,70
★5546 24 0006	120	4 3/4"	6	10	65	10 18,70
★5546 24 0007	120	4 3/4"	7	12	100	10 21,55
★5546 24 0008	120	4 3/4"	8	12	100	10 21,55
★5546 24 0009	120	4 3/4"	9	12	105	10 23,60
★5546 24 0010	120	4 3/4"	10	12	105	10 23,60

5551

Düz Pim Zımba Split Pin Punch

TS 2338
DIN 6450

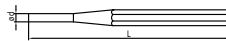

Krom vanadyum, Elektrostatik boyanmış
Chrom vanadium, Electrostatically painted

KOD CODE	L mm	ØD mm	g	TL/Ad.
★5551 24 0002	115	2	30	5 24,75
★5551 24 0006	180	6	125	5 29,15
★5551 24 0008	200	8	155	5 29,15
★5551 24 0010	215	10	190	5 33,25

5701

Kayış Zımba Belt Punch

DIN 7200

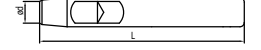

Krom vanadyum, Elektrostatik boyanmış
Chrom vanadium, Electrostatically painted

KOD CODE	ØD mm	L mm	g	TL/Ad.
★5701 24 0003	3	105	35	10 17,30
★5701 24 0004	4	105	45	10 18,15
★5701 24 0005	5	110	55	10 19,70
★5701 24 0006	6	110	60	10 20,10
★5701 24 0007	7	115	70	10 22,10
★5701 24 0008	8	115	80	10 23,60
★5701 24 0009	9	120	100	10 26,25
★5701 24 0010	10	120	115	10 28,00
★5701 24 0011	11	125	130	5 30,00
★5701 24 0012	12	125	145	5 35,95
★5701 24 0013	13	130	160	5 37,95
★5701 24 0014	14	130	170	5 41,55
★5701 24 0015	15	135	250	5 47,70
★5701 24 0016	16	135	300	5 52,20
★5701 24 0017	17	140	345	5 57,10
★5701 24 0018	18	145	405	5 58,80
★5701 24 0019	19	145	410	5 67,75
★5701 24 0020	20	145	440	5 72,15

5801

Tesviyeci Çekiç Machinist Hammer

TS 5
DIN 1041

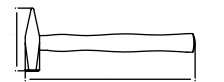

Özel alaşımlı çelik, İndüksiyonda sertleştirilmiş
Special steel, Induction hardened

KOD CODE	L mm	L1 mm	g	g	TL/Ad.
★5801 25 0100	260	82	100	145	10 32,40
★5801 25 0200	280	95	200	245	10 43,60
★5801 25 0500	320	118	500	565	5 67,20
★5801 25 1000	360	135	1000	1145	5 103,05
★5801 25 1500	380	145	1500	1615	5 140,15
★5801 25 2000	400	150	2000	2300	5 172,40

5851

Plastik Çekiç
Plastic Hammer

TS 5



 Yedek parça sayfa 203
Spare parts page 203

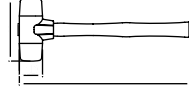

Darbeye dayanıklı, kolay değiştirilebilir başlık
Durable and easily changeable heads

KOD CODE	L mm	ØD mm	H mm	g	TL/Ad.
★5851 25 0030	300	30	100	335	5 51,80

5884

Plastik Şerit Metre
Plastic Measuring tapes



KOD CODE	ÖLÇÜ SIZE	g	TL/Ad.
5884 26 0003	3	95	5 17,75
5884 26 0005	5	195	5 25,60

5891

Testere Kolu
Hacksaw Frame

DIN 6473



KOD CODE	L mm	g	TL/Ad.
5891 26 0830	300	345	5 63,50

6351

Levye Oluklu
Tyre Lever, Straight

TSEK



Krom vanadyum, Krom kaplı
Chrom vanadium, Chrom plated

KOD CODE	L mm	L inch	g	TL/Ad.
6351 26 0400	400	16"	435	5 45,65
6351 26 0500	500	20"	680	5 64,75
6351 26 0600	600	24"	970	5 87,20

6721

Bağ Makası (Lüks)
Pruning Shears (Lux)



Özel alaşımli çelik, Kesici ağızlar induksiyonda sertleştirilmiş, Daldırma PVC izoleli
Special steel, Cutters induction hardened, PVC dipped

KOD CODE	L mm	L inch	g	TL/Ad.
6721 27 0205	205	8"	290	5 85,25

6722

Bağ Makası (Hafif Tip)
Pruning Shears (Light)



Alüminyum gövde, Daldırma PVC izoleli
Aluminum forged body, PVC dipped

KOD CODE	L mm	L inch	g	TL/Ad.
6722 27 0220	220	8 5/8"	240	5 123,00

6730

Çim Kesme Makası (Düz Ağız)
Grass Shears (Straight)



KOD CODE	L mm	L inch	g	TL/Ad.
6730 27 0550	550	21 5/8"	915	5 105,30

6731

Çim Kesme Makası (Eğri Ağız)
Grass Shears (Wave Edges)



KOD CODE	L mm	L inch	g	TL/Ad.
6731 27 0650	650	25 5/8"	1195	5 188,20

8011

Teşhir Panosu
Display



Sacdan imal edilmiş, Fırın boya
Made from metal sheet, Electrostatic paint

KOD CODE	SIZE mm	Cinsi	g	TL/Ad.
8011 31 6001	500x1000x2250	Boş	14000	1 1404,00

IZELTAS®

YEDEK PARÇALAR

SPARE PARTS

Yedek Parçalar
Spare Parts



Kurbağacak Anahtar ve Ayarlı Montaj Anahtarları Yedek Parçaları
Adjustable Wrench, Spare Parts

	KOD CODE	L mm	L inch	g	TL/ Ad.
Somun <i>Nut</i>	0600 01 0206	160	6"	5	10 6,75
	0600 01 0208	208	8"	10	10 8,00
	0600 01 0210	260	10"	10	10 10,65
	0600 01 0212	308	12"	20	10 14,60
	0600 01 0215	388	15"	65	10 21,05
Vida <i>Bolt</i>	0600 01 0306	160	6"	3	10 1,60
	0600 01 0308	208	8"	5	10 2,55
	0600 01 0310	260	10"	5	10 3,15
	0600 01 0312	308	12"	10	10 4,20
	0600 01 0315	388	15"	20	10 5,35
Yay <i>Spring</i>	0600 01 0406	160	6"	1	10 1,20
	0600 01 0408	208	8"	1	10 1,20
	0600 01 0410	260	10"	1	10 1,20
	0600 01 0412	308	12"	1	10 1,20
	0600 01 0415	388	15"	3	10 1,20

2100
Stilson Anahtar Yedek Parçaları
Stilson Wrench Spare Part

	KOD CODE	ÖLÇÜ FOR	g	TL/ Ad.
Çene <i>Jaw</i>	2100 10 0108	8"	80	5 47,55
	2100 10 0110	10"	180	5 70,50
	2100 10 0112	12"	320	5 78,65
	2100 10 0114	14"	400	5 94,85
	2100 10 0118	18"	575	5 127,55
	2100 10 0124	24"	980	5 182,70
	Bağlantı Parçası <i>Connection Part</i>	2100 10 0208	8"	60
2100 10 0210		10"	95	5 108,30
2100 10 0212		12"	100	5 118,65
2100 10 0214		14"	195	5 143,30
2100 10 0218		18"	345	5 164,20
2100 10 0224		24"	445	5 245,50
Somun <i>Nut</i>	2100 10 0308	8"	10	5 35,30
	2100 10 0310	10"	30	5 38,95
	2100 10 0312	12"	25	5 40,70
	2100 10 0314	14"	45	5 45,40
	2100 10 0318	18"	75	5 62,75
	2100 10 0324	24"	105	5 68,60

2300
Zincirli Boru Anahtarları Yedek Zinciri
Spare Chain

KOD CODE	ØD mm	g	TL/ Ad.
★2300 10 1015	1 1/2"	240	1 224,30
★2300 10 1120	12"	4625	1 2347,15

2110
Ağır Tip Boru Anahtarları Yedek Parçaları
Pipe Wrench, Heavy Duty Spare Parts

	KOD CODE	ÖLÇÜ FOR	g	TL/ Ad.	
Çene <i>Jaw</i>	2110 10 0108	8"	100	5 84,15	
	2110 10 0110	10"	205	5 102,30	
	2110 10 0112	12"	235	5 201,85	
	2110 10 0114	14"	400	5 215,30	
	2110 10 0118	18"	675	5 228,75	
	2110 10 0124	24"	900	5 343,15	
	2110 10 0136	36"	1820	5 686,25	
	2110 10 0148	48"	3410	5 1130,25	
	Somun <i>Nut</i>	2110 10 0308	8"	10	5 27,65
		2110 10 0310	10"	25	5 29,00
2110 10 0312		12"	35	5 31,65	
2110 10 0314		14"	40	5 38,40	
2110 10 0318		18"	65	5 51,15	
2110 10 0324		24"	115	5 78,05	
2110 10 0336		36"	230	5 144,70	
2110 10 0348		48"	305	5 232,15	

Alt Çene ve Pim
Lower Jaw and Pin

2110 10 0408	8"	15	5 86,15
2110 10 0410	10"	40	5 95,55
2110 10 0412	12"	60	5 107,65
2110 10 0414	14"	60	5 111,05
2110 10 0418	18"	90	5 115,00
2110 10 0424	24"	125	5 126,50
2110 10 0436	36"	225	5 201,85
2110 10 0448	48"	285	5 272,50

2201
Maşalı Boru Anahtarları Yedek Somun
Nut

KOD CODE	ÖLÇÜ FOR	g	TL/ Ad.
2201 10 0110	1"	25	10 8,10
2201 10 0115	1 1/2"	40	10 10,20
2201 10 0120	2"	60	10 13,60
2201 10 0130	3"	75	10 18,20
2201 10 0140	4"	75	10 21,40

2350
Demir Kesme Makası Yedek
Bolt Cutters Spare Part
Çene
Jaw

KOD CODE	ÖLÇÜ SIZE	KAPASİTE CAPACITY Ø mm	g	TL/ Ad.
2350 27 0118	18"	6 - 8	850	1 193,30
2350 27 0124	24"	8 - 10	870	1 221,55
2350 27 0130	30"	9 - 13	1250	1 392,20
2350 27 0136	36"	11 - 16	1850	1 724,25

5850

Plastik Çekiç Yedek Başlık Plastic Hammer Spare Head



KOD CODE	ØD mm	g	TL/Ad.
5850 25 0130	30	35	10
5850 25 0140	40	70	10
5850 25 0150	50	120	10

6400

Keser Yedek Sapı / Adze Handle



KOD CODE	L mm	g	TL/Ad.
6400 25 0001	400	140	10

5800

Tesviyeci Çekiç Yedek Sapı (Kamalı) Hammer Handle (With Pin)



KOD CODE	L mm	g	g	TL/Ad.
5800 25 0001	260	100	60	10
5800 25 0002	280	200	60	10
5800 25 0003	300	300	95	10
5800 25 0005	320	500	100	10
5800 25 0010	360	1000	165	10
5800 25 0015	380	1500	185	10
5800 25 0020	400	2000	205	10

5865

Madırğa Yedek Sap (Kamalı) Mallet Handle (With Pin)



KOD CODE	L mm	g	TL/Ad.
5865 25 0001	260	1000	210
5865 25 0002	280	1500	270

6410

Nacak Yedek Sap (Kamalı) Hatchet Handle (With Pin)



KOD CODE	L mm	g	g	TL/Ad.
6410 25 0001	380	800	250	10

03755

Kablo Sıyırıcı Yedek Bıçağı Cable Strippers Spare Blade



KOD CODE	ÖLÇÜ SİZE	g	TL/Ad.
03755 50 625	Tek 6/300 Çok 1,5/25	25	5

06375

Ayarlı Yağ Filtresi Sökeceği Yedek Kelepçe Adjustable Slot Type Oil Filter Wrench Spare Clamp



KOD CODE	Ø mm	g	TL/Ad.
06375 50 010	65	20	5



6230

Gres Pompası Yedek Ucu
Grease Gun Nozzle



500cc
300cc

KOD CODE	L mm	Ø mm	g	TL/Ad.
6230 26 2500	38	15	31	10, 10,10

Hortumu
Hose for
Grease Gun



KOD CODE	Ø mm	L mm	g	TL/Ad.
6230 26 3300	8	300	34	10, 13,20
6230 26 3500	12	300	102	10, 24,25

05898

HSS Testere Laması
Hacksaw Blade HSS



KOD CODE	ÖLÇÜ SIZE	g	TL/Ad.
05898 50 283	13x0.65x18	20	100, 17,00

05899

Bimetal Testere Laması
Hacksaw Blade Bimetal



KOD CODE	ÖLÇÜ SIZE	g	TL/Ad.
05899 50 283	13x0.65x18	20	100, 20,95

6735

Dal Budama Testeresi Yedek Bıçak
Spare Blade for Pruning Saw



KOD CODE	L mm	g	TL/Ad.
6735 27 1300	300	60	5, 117,30

06765

Plastik Boru Kesme Makası Bıçağı
Plastic Pipe Cutter Spare Blade



KOD CODE	ÖLÇÜ SIZE	g	TL/Ad.
06765 50 042	42	73	5, 232,90
06765 50 063	63	105	5, 432,65

6850

Mini Boru Kesici Bıçağı / Blade For Mini Tube Cutter
Standart Boru Kesici Bıçağı / Blade For Standard Tube Cutter
Teleskopik Boru Kesici Bıçağı / Blade For Telescopic Tube Cutter



KOD CODE	ÖLÇÜ SIZE	g	TL/Ad.
6850 28 1322	1/4" - 1 3/8"	5	10, 26,00

6865

Profesyonel Boru Kesici Bıçağı
Blade For Professional Tube Cutter



KOD CODE	ÖLÇÜ SIZE	g	TL/Ad.
6865 28 0150	1/8" - 2"	30	5, 53,90



7010-7020

Standart Çektirme Yedek Parçaları Spare Parts For Standard Pullers

Uzatma Parçası / Connection Part, Extention



KOD CODE	L mm	KULLANILAN ÇEKTİRME FOR	g	TL/Ad.
7010 29 2033	200	8x10 - 12x10	415	1 79,30
7010 29 3033	300	16x15 - 20x15	890	1 138,05
7010 29 4033	400	25x20 - 35x20 37x20 - 52x20	2350	1 204,25

Kol / Arm



KOD CODE	KULLANILAN ÇEKTİRME FOR	g	TL/Ad.
7010 29 0822	8x10 - 12x10	110	1 59,65
7010 29 1622	16x15 - 20x15	330	1 103,80
7010 29 2522	25x20 - 35x20 52x20 - 37x20	775	1 182,00

Bağlantı Parçası / Connection Part



KOD CODE	KULLANILAN ÇEKTİRME FOR	g	TL/Ad.
7010 29 0833	8x10 - 12x10	160	1 30,05
7010 29 1633	16x15 - 20x15	325	1 51,95
7010 29 2533	25x20 - 35x20 52x20 - 37x20	930	1 91,00

Mil / Spindle



KOD CODE	KULLANILAN ÇEKTİRME FOR	g	TL/Ad.
7010 29 0844	8x10 - 12x10	185	1 54,55
7010 29 1644	16x15 - 20x15	555	1 104,25
7010 29 2544	25x20	1400	1 179,35
7010 29 3544	35x20 - 37x20	2185	1 233,65
7010 29 5244	52x20	3210	1 233,65

7030-7040

Master Çektirme Yedek Parçaları/Spare Parts For Master Puller

Kol / Arm



KOD CODE	KULLANILAN ÇEKTİRME FOR	g	TL/Ad.
7030 29 0822	8x8	110	1 32,60
7030 29 1222	12x12	215	1 45,25
7030 29 1622	16x16	345	1 80,85
7030 29 2322	23x20	580	1 110,00

Mil/Spindle



KOD CODE	KULLANILAN ÇEKTİRME FOR	g	TL/Ad.
7030 29 0844	8x8	180	1 44,30
7030 29 1244	12x12	360	1 65,25
7030 29 1644	16x16	680	1 72,05
7030 29 2344	23x20	1230	1 98,75

7050-7060

Batarya Çektirme Yedek Parçaları Spare Parts For Battery Pullers

Kol / Arm



KOD CODE	KULLANILAN ÇEKTİRME FOR	g	TL/Ad.
7050 29 0422	6x4	40	1 25,40
7050 29 0622	6x6	50	1 28,35
7050 29 0822	8x8	110	1 32,60

Mil / Spindle



KOD CODE	KULLANILAN ÇEKTİRME FOR	g	TL/Ad.
7050 29 0444	6x4	95	1 37,75
7050 29 0644	6x6	105	1 42,20
7050 29 0844	8x8	200	1 53,15

7070-7080

S Tipi Çektirme Yedek Parçaları Spare Parts For S Type Puller

Kol / Arm



KOD CODE	KULLANILAN ÇEKTİRME FOR	g	TL/Ad.
7070 29 2022	20x13	405	1 65,35

Mil / Spindle



KOD CODE	KULLANILAN ÇEKTİRME FOR	g	TL/Ad.
7070 29 2044	20x13	520	1 91,10

7090-7100

Üniversal Çektirme Yedek Parçaları Spare Parts For Universal Puller

Kol / Arm



KOD CODE	KULLANILAN ÇEKTİRME FOR	g	TL/Ad.
7090 29 2322	22x22	690	1 72,60

Mil / Spindle



KOD CODE	KULLANILAN ÇEKTİRME FOR	g	TL/Ad.
7090 29 2244	22x22	565	1 95,90

5851

Plastik Çekiş Yedek Başlık Plastic Hammer Spare Head



KOD CODE	ØD mm	g	TL/Ad.
★5851 25 0130	30	35	10 11,95
★5851 25 0140	40	70	10 17,20

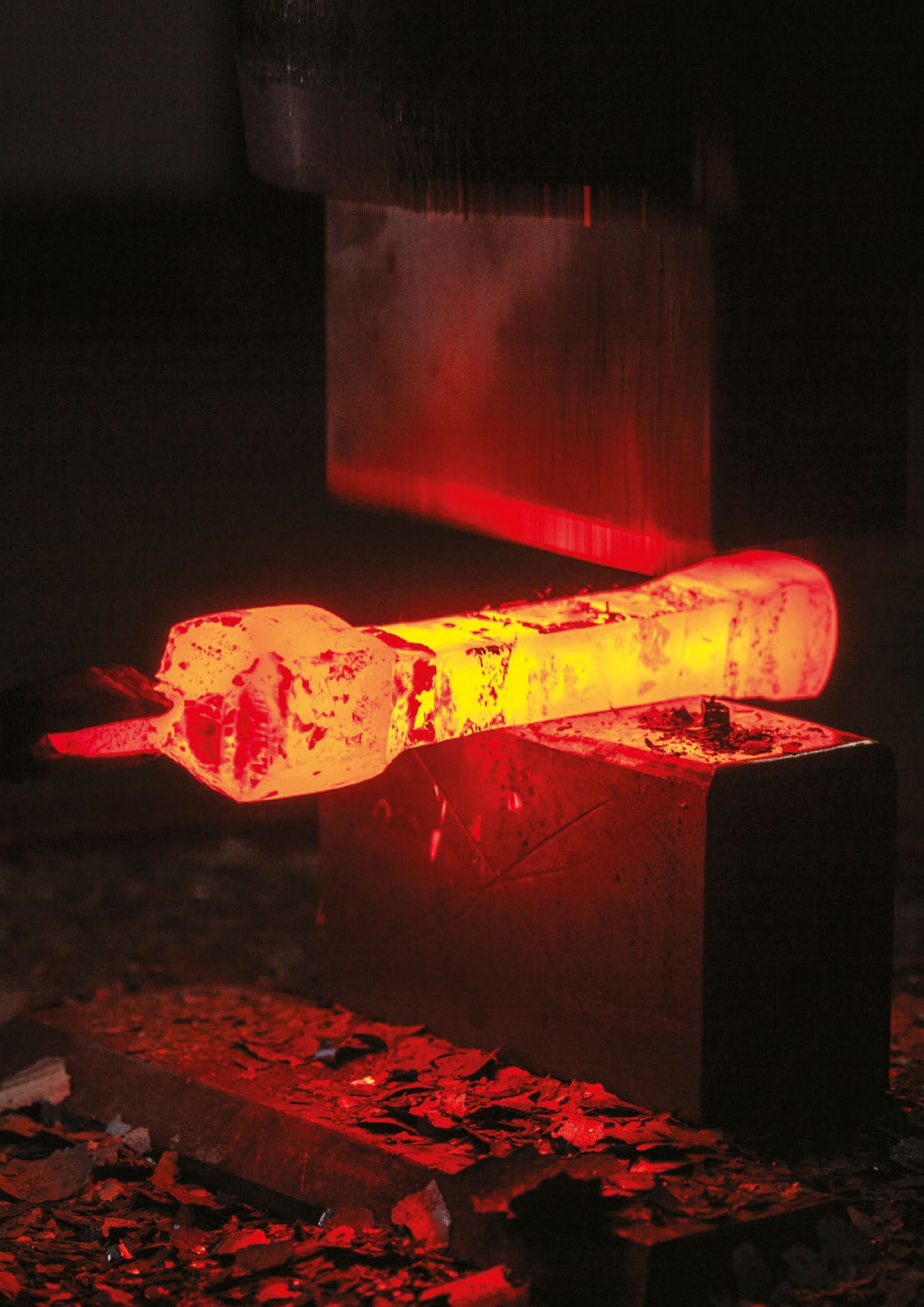

IZELTAS®

TİCARİ TEŞHİR ÜRÜNLERİ

COMMERCIAL DISPLAY PRODUCTS

Ticari Teşhir Ürünleri
Commercial Display Products

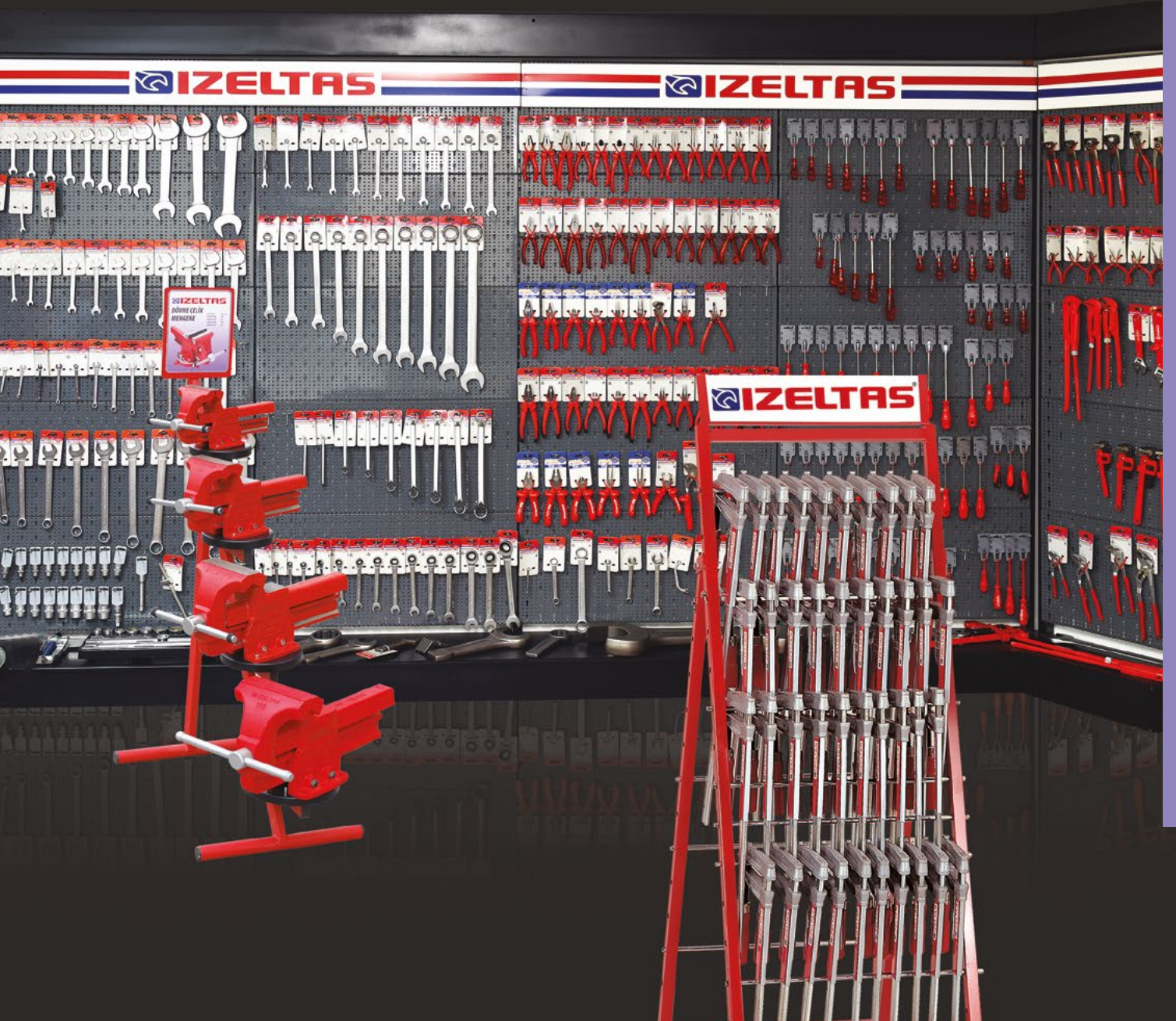

COMMERCIAL
DISPLAY STANDS

TİCARİ TEŞHİR
STANDLARI

1113

1/2" Lokma Anahtar Sehpa
Display Frame for Sockets

**1/2"**

KOD CODE	ÖLÇÜ SIZE mm	g	TL/Ad.
1113 31 6100	175x360x605	5800	1 409,50

2350

Demir Kesme Makası Sehpa
Display Frame for Bolt Cutters

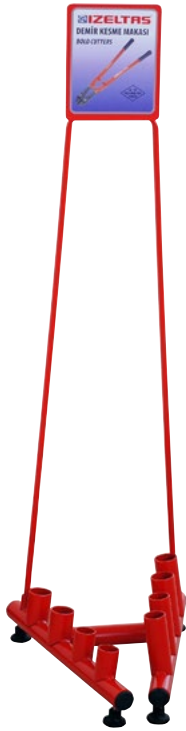

KOD CODE	İÇERİK CONTENTS	g	TL/Ad.
2350 31 6104	Boş - Empty	7400	1 585,00

7010

Çektirme Sehpa
Display Frame For Pullers



KOD CODE	İÇERİK CONTENTS	g	TL/Ad.
7010 31 6105	Boş - Empty	2000	1 122,85

7300

İşkence Sehpa
Display Frame for Screw Clamps



KOD CODE	ÖLÇÜ SIZE mm	g	TL/Ad.
7300 31 6150	100x520x1420	8000	1 502,85

8001-8002

Çatal ve Yıldız Anahtar Sehpası Display Frame For Wrenches



Sacdan imal edilmiş, Fırın boya
Made from metal sheet, Electrostatic paint

KOD CODE	ÖLÇÜ SIZE mm	g	İÇERİK CONTENTS	TL/Ad.
8001 31 6012	160x500	800	Çatal / Open Jaw	1 65,25
8002 31 6012	170x560	1000	Yıldız / Ring	1 81,35

8004

Dövme Çelik Mengene Sehpası Forged Steel Vice Frame



KOD CODE	İÇERİK CONTENTS	g	TL/Ad.
8004 31 6004	Boş - Empty	8000	1 623,35

8015

Tekerlekli Üçgen Teşhir Standı Triangular Display Frame



Sacdan imal edilmiş, Fırın boya
Made from metal sheet, Electrostatic paint

KOD CODE	ÖLÇÜ SIZE mm	g	TL/Ad.
8015 31 6001	520x1670	29500	1 883,95



(★) İşaretili olan ürünler stoklarla sınırlıdır.
Limited with stocks.

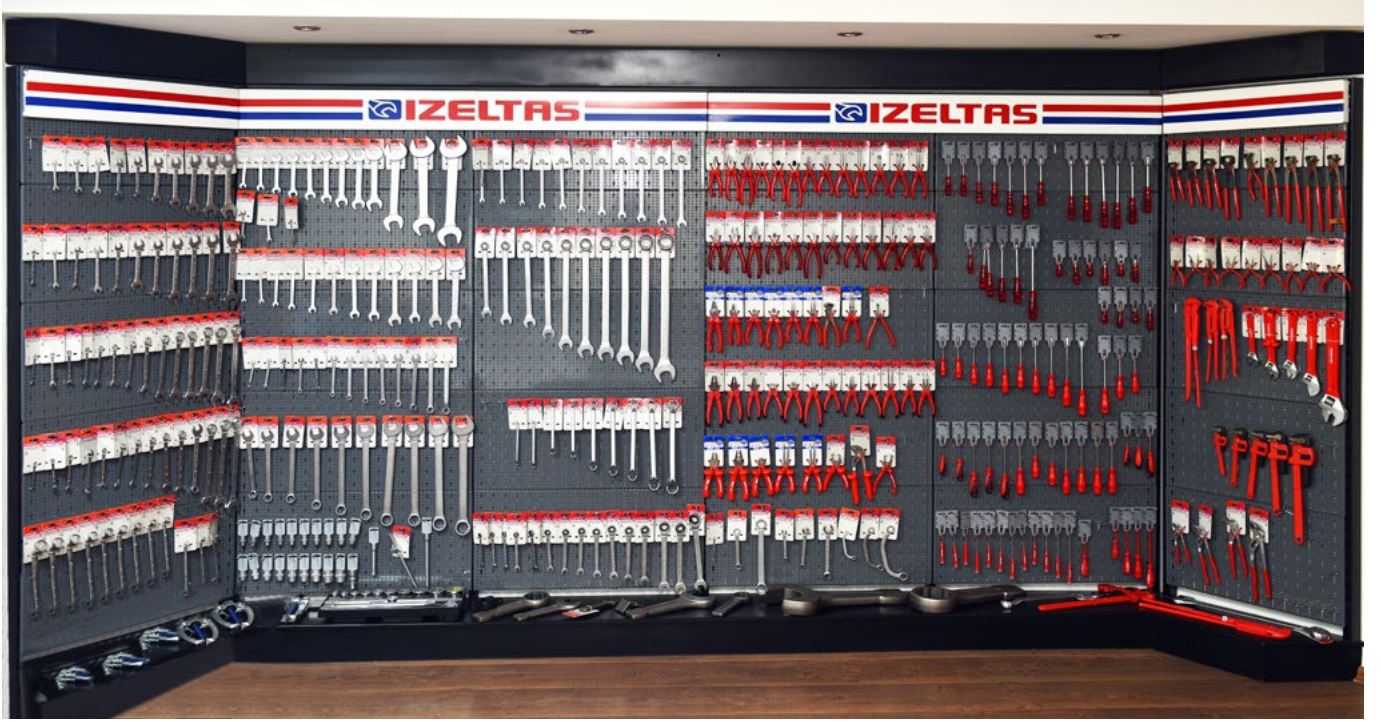

İzeltaş El Aletleri Teşhir Panosu, satış noktaları için özel olarak dizayn edilmiştir. Kolayca monte edilebilen 19 ana parçadan oluşan panonun derinliği 46 cm, genişliği 100 cm, yüksekliği 220 cm'dir. Etkili görünümü ve tüm ürünleri bir arada sergileme özelliği yanında, perakende satışlarda seçme kolaylığı sağlaması bakımından da önem taşımaktadır.

İzeltaş's Product Exhibition Board has been specially designed for selling points. These boards have been formed from easily mountable 19 main parts and have the dimensions as following, width 46 cm, length 100 cm and height 220 cm.

Board features an impressive looking and displays the products all together, which makes it easy to choose desired tools during retail selling activities.

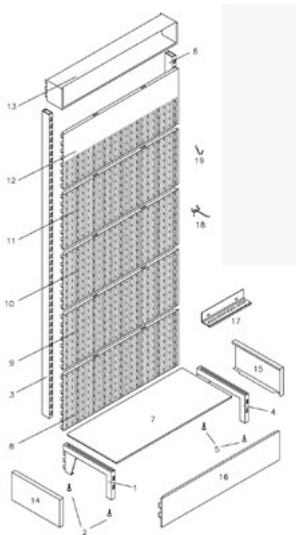

Montaj Sırası / Montage Order

1. Ayak / Stand right leg
2. Plastik ayak / Plastic leg
3. Kolon / Stand right column
4. Ayak / Stand left leg
5. Plastik ayak / Plastic leg
6. Kolon / Stand left column
7. Raflar / Shelf
8. Delikli pano / Drilled panel
9. Delikli pano / Drilled panel
10. Delikli pano / Drilled panel
11. Delikli pano / Drilled panel
12. Yarım delikli pano / Half - drilled panel
13. Aydınlatma alınlığı / Illumination panel
14. Yan kapak / Side cover
15. Yan kapak / Side cover
16. Ön kapak / Front cover
17. Tornavida askısı / Screwdriver hanger
18. Büyük askı / Long hanger
19. Küçük askı / Short hanger

Büyük Pano Display Panel (Empty)

KOD CODE	ÖLÇÜ SIZE mm	Cinsi	g	TL/Ad.
8010 31 6001	460x1000x2200	Boş/Empty	43000	1 1696,50

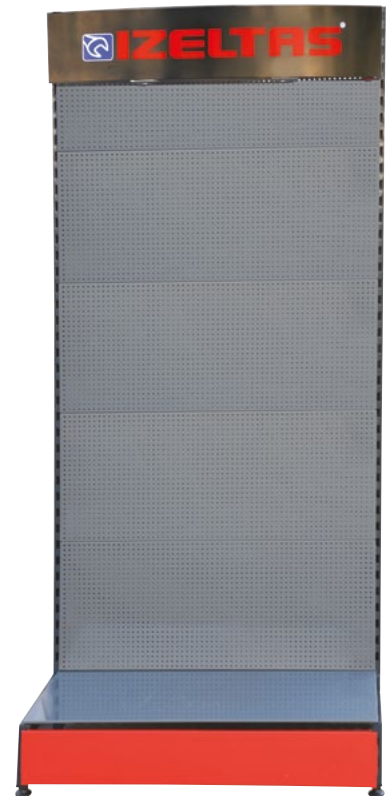

TEKNİK BİLGİLER

TECHNICAL INFORMATIONS

Teknik Bilgiler
Technical Informations



İş Güvenliği ve El Aletlerinin Yanlış Kullanımı



Elektrik akımı geçme (1000V üzeri hariç) ihtimali olan tüm yerlerde IEC 60900'a göre izoleli uygun el aletleri kullanılmalıdır.
Hand tools with IEC 60900 compliant isolation must be used for any work involving risk of electrical current (excluding 1000V and above).



Tozlu ve çapaklı alanlarda mutlaka gözlük kullanınız.
Make sure to wear goggles in work areas with dust and burrs.



Lokma anahtarlarınızı uygun ölçülerdeki cıvata, en geniş yüzeyde dik olarak kullanınız. Lokma anahtarların cıvataya eğik olarak takılıp kullanılması, kavrama yüzeyini azaltarak ürünün kullanım ömrünü kısaltacaktır.
Use box wrenches with bolts of appropriate size, placed perpendicularly on the largest area of contact. Use of a box wrench at an angle will reduce the gripping surface and result in a shorter useful life.



Yüksek sesli ortamlarda mutlaka kulaklık kullanınız.
Make sure to wear ear protection in work areas with high levels of noise.



Çekici amacı dışında kendinden daha sert malzemelere vurmuyunuz, eğik olarak kullanmayınız. Mantarlaşmış bölgeleri mutlaka temizleyerek kullanınız.
Do not use a hammer outside its intended purpose or to hit objects harder than the hammer. Do not hit at an angle. Make sure to clean weakened parts before use.



Kimyasal madde içeren işlerde mutlaka eldiven ve maske kullanınız. Make sure to wear gloves and facemask for works involving chemical materials.

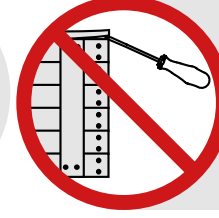

Tornavidayı amacı dışında sökme işlemlerinde kullanmayınız.
Do not use the screwdriver as a levering tool out of its intended purpose.



Anahtarlarınızı, ağız ölçüsüne uygun cıvatalarda kullanınız. Anahtar ve cıvata arasındaki ölçü uyumsuzluğu, üründe ağız aşınmasına neden olur.
Use wrenches with bolts of appropriate size. Size discrepancy between wrench and bolt will lead to wear on tool edge.



Tornavidayı amacı dışında keski gibi ya da darbeli olarak kullanmayınız.
Do not use the screwdriver as a chiselling tool or for impacting out of its intended purpose.



Anahtarların ağızına taşlama işlemi yapmayınız; sert cisimler sürterek müdahale etmeyiniz. Bu durum anahtarınızın ağız yapısını bozar.
Do not grind or expose the edge of wrenches to hard objects. This will deform the tool edge structure.



Dolapları çekerek değil iterek kullanınız.
Do not pull the set cabinets. Push to move the cabinets.



Anahtar gövdesine boru takarak kuvvet uygulamayınız. Anahtarınızın ağız yapısının bozulmasına, kırılmalara ve yaralanmalara neden olabilir.
Do not apply force to the wrench by attaching a pipe to the tool body. This may result in deformation of tool edge, breakage or injury.



Dolapların birden fazla çekmesini aynı anda açık bırakmayınız. Ağırlık merkezi değişerek dolabın devrilmesine neden olacaktır.
Do not leave multiple drawers of set cabinets open at the same time. This will move the centre of gravity and cause toppling.



Anahtar gövdesine çekiç ile darbe uygulamayınız. Ağız yapısında bozulmalara, kırılma ve yaralanmalara neden olabilir.
Do not hit the wrench body with a hammer. This may result in deformation of tool edge, breakage or injury.



Dolapların çekmecelerini ayağınızla kapatmaya ya da basarak, merdiven olarak kullanmaya çalışmayınız. Bu gibi durumlar yaralanmalara sebep olacaktır.
Do not use your foot to close a cabinet drawer or attempt to use cabinet drawers as a stepladder. Such actions will result in injury.

TEKNİK BİLGİLER/TECHNICAL DATA

ANAHTAR AĞZI ÖLÇÜLERİ VE VİDA ÇAPLARI SPANNER JAW WIDTH ACCROSS FLATS and THREAD DIAMETERS

mm	DIN ISO 272 ye göre metrik	DIN ISO 272 ye göre metrik	AF	Ağız Genişliği		Civata Çapı Whitw. BS 916 1083	Ağız Genişliği		
				inch	mm		inch	mm	
4	2		5/32	0,1562	3,97	8 BA	0,152	3,86	
4,5	2,3					7 BA	0,172	4,87	
5	2,5		3/16	0,1875	4,76	6 BA	0,193	4,90	
5,5	3,5		7/32	0,2187	5,56	5 BA	0,220	5,59	
6	26,8		1/4	0,2500	6,35	4 BA	0,248	6,30	
						1/16 W	0,256	6,50	
7	4		9/32	0,2812	7,14	3 BA	0,282	7,16	
						3/32 W	0,297	7,54	
7-8	5		5/16	0,3125	7,94	2 BA	0,324	8,23	
9	5 Alt		11/32	0,3438	8,73	1/8 W	0,340	8,64	
			3/8	0,3750	9,52	1 BA	0,365	9,27	
8-10	6		13/32	0,4062	10,32	0 BA	0,413	10,49	
11	7		7/16	0,4375	11,11	3/16 W	1/4	0,445	11,30
12									
10-13	8		1/2	0,5000	12,70	1/4 W	5/16	0,525	13,34
14*	8 Alt		9/16	0,5625	14,29				
15	10 KFZ		19/32	0,5938	15,08	5/16 W	3/8	0,600	15,24
16	10		5/8	0,6250	15,88				
13-15-17	10		11/16	0,6875	17,46				
18	12					3/8 W	7/16	0,710	18,03
15-18-19	12		3/4	0,7500	19,05				
20*			25/32	0,7812	19,84				
18-21	14		13/16	0,8125	20,64	7/16 W	1/2	0,820	20,83
22-24	14	12	7/8	0,8750	22,22				
23*						1/2 W	9/16	0,920	23,37
21-24*	16		15/16	0,9375	23,81				
25*-27*			1,	1,0000	25,40				
26*						9/16 W	5/8	1,010	25,65
27	18	16	1.1/16	1,0625	26,99				
27-28*-30						5/8 W	(11/16)	1,100	27,94
			1.1/8	1,1250	28,58				
27-30-34	20		1.3/16	1,1875	30,16	11/16 W	3/4	1,200	30,48
32-36-41	22	20	1.1/4	1,2500	31,75				
			1.5/16	1,3125	33,34	3/4 W	7/8	1,300	33,02
34	22		1.3/8	1,3750	34,92	13/16 W	(15/16)	1,390	35,31
36-41	24	22	1.7/16	1,4375	36,51				
38*			1.1/2	1,5000	38,10	7/8 W	1	1,480	37,59
41-46	27	24	1.5/8	1,6250	41,28				
			1.11/16	1,6875	42,86	1. W	1.1/8	1,670	42,42
			1.3/4	1,7500	44,45				
46-50	30	27	1.13/16	1,8125	46,04				
			1.7/8	1,8750	47,62	1.1/8 W	1.1/4	1,860	47,24
50-55	33	30	2,	2,0000	50,80				
			2.1/16	2,0625	52,39	1.1/4 W	1.3/8	2,050	52,07
55-60	36		2.3/16	2,1875	55,56				
			2.1/4	2,2500	57,15	1.3/8 W	1.1/2	2,220	56,39
60-65	39	36	2.3/8	2,3750	60,32				
			2.7/16	2,4375	61,91	1.1/2 W	1.5/8	2,410	61,21
65	42		2.9/16	2,5625	65,09	1.5/8	1.3/4	2,580	65,53
			2.5/8	2,6250	66,68				
70	45		2.3/4	2,7500	69,85	1.3/4 W	2,	2,760	70,10
			2.13/16	2,8125	71,44				
75	48		2.15/16	2,9375	74,61				
			3,	3,0000	76,20	(1.7/8 W)			76,70
80	52		3.1/8	3,1250	79,38	2. W	2.1/4	3,150	80,01
85	56		3.3/8	3,3750	85,72				
90	60		3.1/2	3,5000	88,90		2.1/2	3,550	90,17
95	64		3.3/4	3,7500	92,25				
			3.7/8	3,8750	98,42		2.3/4	3,890	98,81
100	68								
105	72		4.1/8	4,1250	104,78		3,	4,180	106,17
110	76		4.1/4	4,2500	107,95				
115*	80		4.1/2	4,5000	114,30		3.1/4	4,530	115,06

ANAHTAR İÇİN MİNİMUM DÖNDÜRME MOMENTLERİ TEST TORQUE VALUES FOR SPANNERS ISO 1711-1

mm	0430	0440	0100	1800	1870
0320			0130		1874
0330					
0370					
4			1,90		
4.5*			2,64		
5			3,55		
5,5			4,64		
6*	17,6	7,4	5,92	17,6	
7	25,2	11,4	9,12	25,2	
8	34,5	16,6	13,3	34,5	34,5
9*	45,5	23,0	18,4	45,5	45,5
10	58,1	31,0	24,8	58,1	58,1
11	72,7	40,4	32,3	72,7	72,7
12	89,1	51,5	41,2	89,1	89,1
13	107	64,5	51,6	107	107
14*	128	79,4	63,5	128	128
15	150	96,2	77,0	150	150
16	175	115	92,3	175	175
17	201	134	107	201	201
18	230	160	128	230	230
19*	261	186	149	261	261
20*	294	215	172	294	294
21	330	247	198	330	330
22*	368	281	225	368	368
23*	408	319	255	408	408
24	451	359	287	451	451
25*	496	402	322	496	496
26*	544	449	359	544	544
27	594	499	399	594	594
28*	647	552	442	647	647
30	760	670	536	760	760
32*	884	804	643	884	884
34	1019	951	761	1019	1019
36	1165	1117	994	1165	1165
41	1579	1442	1154	1579	1579
46	2067	1816	1453	2067	2067
50	2512	2145	1716	2512	2512
55	3140		2077	3140	3140
60	3849		2471	3849	
65	4021				
70	4658				
75	5394				

* Standart dışı/Not Standardised

* Standart dışı/Not Standardised

VIDA AĞIZ ÖLÇÜLERİ
GUIDELINE FOR SCREWDRIVERS

											
"Metrik Vida Metric screw"	M 1.6 (M 1.7)	M 2	M 2.3	(M 2.3) (M 2.6)	M 3	(M 3.5)	M 4	M 5	M 6	M 8	M 10
Düz başlı Vidalar Flat head screws	0.4 x 3 (3.2)	0.5 x 3.8	0.6 x 4.4	0.6 x 4.5 (5)	0.8 x 5.5	0.8 x 6	1 x 7	1.2 x 8.5	1.6 x 10	2 x 13	2.5 x 16
Düz başlı Vidalar Flat head screws	—	—	—	—	0.8 x 6	0.8 x 7	1 x 8	1.2 x 10	1.6 x 12	2 x 16	2.5 x 20
Düz başlı Vidalar (küçük) Flat head screws (small sizes)	—	—	—	0.4 x 3.5	0.5 x 4	0.5 x 4.5	0.6 x 5.5	0.8 x 6.5	1 x 8	1.2 x 10	1.6 x 13
Oval başlı Vidalar Oval head screws	0.4 x 3	0.5 x 3.8	—	0.6 x 4.7	0.8 x 5.6	—	—	—	—	—	—
Havşa başlı Vidalar Countersank head screws	0.4 x 3	0.5 x 3.8	—	0.6 x 4.7	0.8 x 5.6	0.8 x 6.5	1 x 7.5	1.2 x 9.2	1.6 x 11	2 x 14.5	2.5 x 18

YILDIZ VIDALAR İÇİN UYGUN TORNAVİDA AĞIZ ÖLÇÜLERİ
SUITABLE TIPS FOR CROSS HEAD SCREWS

		
Yıldız Ağız Ölçüsü Cross Slot Size		Metrik Vidalar Metric Screw
0		M 1.6 - M 2
1		M 2 - M 2.5 - M 3
2		M 3.5 - M 5
3		M 6
4		M 8 - M 10



TEKNİK BİLGİLER/TECHNICAL DATA

METRİK VIDALAR İÇİN LOKMA SEÇİMİ GUIDE TO METRIC SIZES COVERED BY SOCKET WRENCHES FOR EACH DRIVE

	1107 6,3	1110 10	1113 12,5	1119 20	1125 25
	1/4"	3/8"	1/2"	3/4"	1"
M 2	4				
	4,5				
M 2.5	5				
M 3	5,5				
M 3.5	6	6			
M 4	7	7			
M 5	8	8	8		
	9	9	9		
M 6	10	10	10	10	
M 7	11	11	11	11	
	12	12	12	12	
M 8	13	13	13	13	
		14	14	14	
		15	15	15	
M 10		16	16	16	
M 10		17	17	17	17
M 12		18	18	18	18
M 12		19	19	19	19
		20	20		
M 14		21	21	21	
M 14		22	22	22	22
		23	23		
M 16			24	24	24
			25		
			26		
M 18			27	27	27
			28		
M 20			30	30	30
M 22			32	32	32
			33	33	33
M 22		34	34	34	34
M 24			36	36	36
			38	38	38
M 27			41	41	41
				42	
M 30				46	46
M 33				50	
M 36				55	
M 39				60	
M 42				65	
M 45				70	
M 48				75	
M 52					

LOKMA İÇİN MİN DÖNDÜRME MOMENTLERİ TEST TORQUE VALUES FOR SOCKET ISO 1711-1 (N-m)

		6,3 1107	10 1110	12,5 1113 1114	20 1119 1120	25 1125
	mm	1/4	3/8	1/2	3/4	1
M2	4	10,4				
M 2.2	4.5*	12,6				
M 2.5	5	15,1				
M 3	5,5	17,8				
M 3.5	6*	20,6	23,2			
M 4	7	26,8	33,2			
M 5	8	33,6	45,5	94,1		
	9*	41,1	59,9	119,2		
M 6	10	49,1	76,7	147		
M 7	11	57,8	96	178		
	12	67,0	118	212		
M 8	13	68,6	141	249		
	14*	68,6	169	288		
	15		198	331		
	16		225	377		
M 10	17		225	425		
	18		225	477		
M 12	19*		225	531		
	20*		225	569		
	21		225	569	-	
M 14	22*		225	569	569	
	23*			569	569	
M 16	24			569	569	
	25*			569	583	
	26*			569	624	
M 18	27			569	665	
	28*			569	707	
M 20	30			569	795	
M 22	32*			569	888	
	34			569	984	
M 24	36				1084	1677
M 27	41				1353	1910
M 30	46				1569	2143
M 33	50				1569	2329
M 36	55				1569	2562
M 39	60				1569	2795
M 42	65					2795
M 45	70					2795
M 48	75					2795
M 52	80					2795

SIKMA / TEST TORK DEĞERLERİ TIGHTENING / TEST TORQUE VALUES

Önerilen (Bağlayıcı olmayan) cıvata sıkma torkları Nm (Newton Metre)
Suggested (Not Compulsory) Bolt Tightening Torque in Nm (Newton Meter)

Kalite Sınıfı DIN 267'ye Göre Sıkma Değerleri
Tightening Torques Values According to Quality Class DIN 267

	4.6	5.6	6.9	8.8	10.9	12.9
M 2	0,123	0,162	0,314	0,373	0,520	0,628
M 2,2	0,196	0,265	0,510	0,598	0,843	1,010
M 2,5	0,284	0,373	0,726	0,863	1,206	1,451
M 3	0,441	0,588	1,128	1,344	1,883	2,256
M 3,5	0,677	0,902	1,736	2,060	2,893	3,481
M 4	1,000	1,344	2,599	3,040	4,315	5,148
M 5	1,916	2,648	5,099	6,031	8,483	10,200
M 6	3,432	4,511	8,728	10,300	14,710	17,652
M 7	5,590	7,453	14,220	17,162	24,517	28,439
M 8	8,238	10,787	21,575	25,497	35,304	42,168
M 10	16,67	21,575	42,168	50,014	70,608	85,317
M 12	28,44	38,246	73,550	87,279	122,60	147,10
M 14	45,11	60,801	116,70	138,30	194,20	235,40
M 16	69,63	93,163	178,5	210,80	299,10	357,90
M 18	95,12	127,50	245,20	289,3	411,90	490,30
M 20	135,3	180,45	384,10	411,90	578,60	696,30
M 22	182,4	245,16	470,70	559,00	784,50	941,40
M 24	230,5	308,91	598,20	711,00	1000	1196
M 27	343,2	460,90	887,50	1049	1481	1775
M 30	465,8	622,72	1206	1422	2010	2403
M 33	632,5	848,30	1628	1932	2716	3266
M 36	814,0	1089	2099	2481	3491	4197
M 39	1059	1412	2716	3226	4531	5443
M 42	1304	1746	3364	3991	5609	6727
M 45	1638	2177	4207	4992	7012	8414
M 48	1981	2638	5080	6021	8473	10150
M 52	2540	3393	6541	7747	10885	13092
M 56	3168	4227	8149	9650	13582	16279
M 60	3932	5247	10101	11964	16867	20202
M 64	4737	6306	12160	14416	20300	24320

Moment Değerleri Yağlanmış Cıvatalar İçin %20 Azaltılmalıdır.
Torque Values Should be Decreased of 20% for Lubricated Screws

Ölçü Birimleri

Measuring Units

Giga	G	1.000.000.000	=10 ⁹	1GW= 1 Milyar Watt
Mega	M	1.000.000	=10 ⁶	1 MW= 1 Milyon Watt
Kilo	k	1.000	=10 ³	1 kW= Bin Watt
Milli	m	0.001	=10 ⁻³	1 mm= Binde Bir Watt
Mikro	m	0.000001	=10 ⁻⁶	1 mm= 1 Milyonda Bir Watt
Nano	n	0.000000001	=10 ⁻⁹	1 nm= 1 Milyarda Bir Watt

Önemli Ölçülerin Değişim Tablosu

Conversion Table For Essential Measuring Units

Uzunluk Length	Metre	m		
Kütle Weight	Kilogram	kg		
Zaman Time	Saniye	s		
Kuvvet Force	Newton	N	=kg m/s ²	1 N= 0.102 kp
Döndürme Mom. Torque	Newtonmetre			9.81 Nm= 1kpm
İş Enerjisi Work	Joule	J	=Nm	
Isı Enerjisi Heat	Joule	J		1 J= 0.239 cal
Güç Power	Watt	W	=Nm/s	1 kW= 1.36 PS=860 kcal/h
Basınç Pressure	Pascal	Pa	=N/m ²	100.000 Pa=1 bar=10 mWS
Elektrik Akımı Electricity Current	Amper	A		
Sıcaklık Temperature	Kelvin	K		1K= -272.15 °C

Döndürme Momenti Dönüşüm Tablosu

Conversion Table For Bending Moments

Var Olan Ölçüler/ present units	İstenen Ölçüler / Wanted Units					
	=Ncm	=Nm	=kpcm	=kpm	=lbf.in.	=lbf.ft.
Ncm	1	0.01	0.10197	0.00102	0.0885	0.00738
Nm	100	1	10.197	0.10197	8.851	0.7376
kpcm	9.807	0.09807	1	0.01	0.868	0.0723
kpm	980.07	9.807	100	1	86.796	7.233
lbf.in.	11.298	0.11298	1.152	0.01152	1	0.0833
lbf.ft.	135.58	1.3558	13.825	0.13825	12	1

Newton-Metre ve Librefoot Dönüşüm Tablosu

Conversion Table Of Newton-Meter And Librefoot
(1 Nm=0.738 lbf.ft.)

Nm	ft.,lbs.									
	0	1	2	3	4	5	6	7	8	9
0	0	0.74	1.48	2.21	2.95	3.69	4.43	5.17	5.90	6.64
10	7.38	8.12	8.86	9.59	10.33	11.07	11.81	12.54	13.28	14.02
20	14.76	15.50	16.2	16.97	17.71	18.45	19.19	19.93	20.65	21.40
30	22.14	22.88	23.62	24.35	25.10	25.83	26.57	27.31	28.04	28.78
40	29.52	30.26	31.00	31.73	32.47	33.21	33.95	34.69	35.42	36.16
50	36.90	37.64	38.38	39.11	39.85	40.59	41.33	42.07	42.80	43.54
60	44.28	45.02	45.76	46.49	47.23	47.97	48.71	49.45	50.18	50.92
70	51.66	52.40	53.14	53.87	54.61	55.35	56.09	56.83	57.56	58.30
80	59.04	59.78	60.52	61.25	62.00	62.73	63.47	64.21	64.94	65.68
90	66.42	67.16	67.90	68.63	69.37	70.11	70.85	71.59	72.32	73.06
100	73.80	74.54	75.28	76.01	76.75	77.49	78.23	78.97	79.70	80.44

Librefoot ve Newton-Metre Dönüşüm Tablosu

Conversion Table Of Librefoot And Newton-Meter
(1 lbf.ft.=1.356 Nm)

ft.- lbs.	Nm									
	0	1	2	3	4	5	6	7	8	9
0	0	1.36	2.71	4.07	5.42	6.78	8.14	9.49	10.85	12.20
10	13.56	14.92	16.27	17.63	18.98	20.34	21.70	23.05	24.41	25.76
20	27.12	28.48	29.83	31.19	32.54	33.90	35.26	36.61	37.97	39.32
30	40.68	42.04	43.39	44.75	46.10	47.46	48.82	50.17	51.53	52.88
40	54.24	55.60	56.95	58.31	59.66	61.02	62.38	63.73	65.09	66.44
50	67.80	69.16	70.51	71.87	73.22	74.58	75.94	77.29	78.65	80.00
60	81.36	82.72	84.07	85.43	86.78	88.14	89.50	90.85	92.21	93.56
70	94.92	96.28	97.63	98.99	100.34	101.70	103.06	104.41	105.77	107.12
80	108.48	109.84	111.19	112.55	113.90	115.26	116.62	117.97	119.33	120.68
90	122.04	123.40	124.75	126.11	127.46	128.82	130.18	131.53	132.89	134.24
100	135.60	136.96	138.31	139.67	141.02	142.38	143.74	145.09	146.45	147.80

Newton-Metre ve Kilopound-Metre Dönüşüm Tablosu

Conversion Table Of Newton-Meter and Kilopound-Meter
(1 Nm=0.102 kpm)

Nm	kpm									
	0	1	2	3	4	5	6	7	8	9
0	0.00	1.02	2.04	3.06	4.08	5.10	6.12	7.14	8.16	9.18
100	10.20	11.22	12.24	13.26	14.28	15.30	16.31	17.33	18.35	19.37
200	20.39	21.41	22.43	23.45	24.47	25.49	26.51	27.53	28.55	29.57
300	30.59	31.61	32.63	33.65	34.67	35.69	36.71	37.73	38.75	39.77
400	40.79	41.81	42.83	43.85	44.87	45.89	46.91	47.93	48.95	49.97
500	50.99	52.00	53.02	54.04	55.06	56.08	57.10	58.12	59.14	60.16
600	61.18	62.20	63.22	64.24	65.26	66.28	67.30	68.32	69.34	70.36
700	71.38	72.40	73.42	74.44	75.46	76.48	77.50	78.52	79.54	80.56
800	81.58	82.60	83.62	84.64	85.66	86.68	87.70	88.71	89.73	90.75
900	91.77	92.79	93.81	94.83	95.85	96.87	97.89	98.91	99.93	100.95
1000	101.97	102.99	104.01	105.03	106.05	107.07	108.09	109.11	110.13	111.15



Sertlik Dönüşüm Tablosu

Hardness Conversion Table

Vickers Sertlik Hardness	Brinell Sertlik Hardness	Rockwell Sertlik Hardness		Çekme dayanımı Tensile Strength
HV 30	HB 30	HRB	HRC	sB N/mm2
80	80.7	36.4	-	270
85	85	42.4	-	290
90	90	47.4	-	310
95	95	52.00	-	320
100	100	56.4	-	340
105	105	60.0	-	360
110	110	63.4	-	380
115	115	66.4	-	390
120	120	69.4	-	410
125	125	72.0	-	420
130	130	74.4	-	440
135	135	76.4	-	460
140	140	78.4	-	470
145	145	80.4	-	490
150	150	82.2	-	500
155	155	83.8	-	520
160	160	85.4	-	540
165	165	86.8	-	550
170	170	88.2	-	570
175	175	89.6	-	590
180	180	90.8	-	600
185	185	91.8	-	620
195	190	91.5	-	640
200	195	94.0	-	660
200	200	95.0	-	670
205	205	95.8	-	680
210	210	96.6	-	710
215	215	97.4	-	720
220	220	98.2	-	730
225	225	99.0	-	750
230	230	-	19.2	760
235	235	-	20.2	780
240	240	-	21.2	800
245	245	-	22.1	820
250	250	-	23.0	830
255	255	-	23.8	850
260	260	-	24.6	870
265	265	-	25.4	880
280	280	-	27.1	900
275	275	-	26.9	920
280	280	-	27.6	940
285	285	-	28.3	950
290	290	-	29.0	970
295	295	-	29.6	990
300	300	-	30.3	1010
310	310	-	31.5	1040
320	320	-	32.7	1080
330	330	-	33.8	1110

Vickers Sertlik Hardness	Brinell Sertlik Hardness	Rockwell Sertlik Hardness		Çekme dayanımı Tensile Strength
HV 30	HB 30	HRB	HRC	sB N/mm2
340	340	-	34.9	1140
350	350	-	36.0	1170
360	359	-	37.0	1200
370	368	-	38.0	1260
380	376	-	38.9	1260
390	385	-	39.8	1290
400	392	-	40.7	1320
410	400	-	41.5	1350
420	408	-	42.4	1380
440	423	-	44.0	1430
450	430	-	44.8	1460
460	-	-	45.6	-
470	-	-	46.3	-
480	-	-	47.0	-
490	-	-	47.7	-
500	-	-	48.3	-
510	-	-	49.1	-
520	-	-	49.7	-
530	-	-	50.4	-
540	-	-	51.0	-
550	-	-	51.6	-
560	-	-	52.2	-
570	-	-	52.8	-
580	-	-	53.3	-
590	-	-	53.9	-
600	-	-	54.4	-
610	-	-	55.0	-
620	-	-	55.5	-
630	-	-	56.0	-
640	-	-	56.5	-
650	-	-	57.0	-
660	-	-	57.5	-
670	-	-	58.0	-
680	-	-	58.5	-
690	-	-	59.0	-
700	-	-	59.5	-
720	-	-	60.4	-
740	-	-	61.2	-
760	-	-	62.0	-
780	-	-	62.8	-
800	-	-	63.6	-
820	-	-	64.3	-
840	-	-	65.0	-
860	-	-	65.7	-
880	-	-	66.3	-
900	-	-	66.9	-
920	-	-	67.5	-
940	-	-	68.0	-

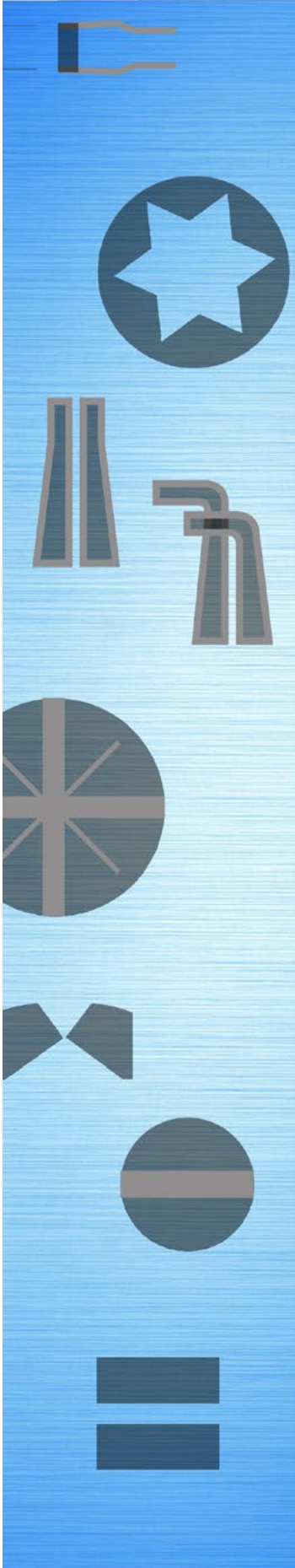

Semboller / Symbols

Anahtar Ağız
Size



Ağız Açıklığı
Opening Limit of Jaws



Altı Köşe Lokma Bijon
Anahtar Ağız
Six Point Sockets



Sekiz Köşe Anahtar Ağız
Eight Point Wrench



On iki Köşe Anahtar Ağız
Twelve Point Wrench



Kare Adaptör
Square Adapter



Kovan Anahtar
Tubular Socket Wrench



Bir Ağız Bijon Anahtar
Single Ended Rim Wrench



TORX Lokma Anahtar
TORX Socket



Düz Uç
Flat Tip



Yıldız Uç
PHILLIPS Tip



POZIDRIV Yıldız Uç
POZIDRIV Tip



TORX Uç
TORX Tip



Delikli TORX Uç
TORX with hole



Bits Tutucular
Bit Holders



Allen Anahtar
Hexagonal Allen Keys



Segman
Circlip



Gövde Ağırlık
Weight of Body



Tapa Anahtar
Wrench for Carter Case



İşkençe
Screw Clamp



Çektirme
Puller

in.	dec.in.	0"	1"	2"	3"	4"	5"	6"	7"	8"	9"	10"	11"
millimeters (mm)													
0	0	0	25.400 0	50.800 0	76.200 0	101.600 0	127.000 0	152.400 0	177.800 0	203.200 0	228.600 0	254.000 0	279.400 0
1/64	0.015 625	0.396 9	25.796 9	51.196 9	76.596 9	101.996 9	127.396 9	152.796 9	178.196 9	203.596 9	228.996 9	254.396 9	279.796 9
1/32	0.031 25	0.793 8	26.193 8	51.593 8	76.993 8	102.393 8	127.793 8	153.193 8	178.593 8	203.993 8	229.393 8	254.793 8	280.193 8
3/64	0.046 875	1.190 6	26.590 6	51.990 6	77.390 6	102.790 6	128.190 6	153.590 6	178.990 6	204.390 6	229.790 6	255.190 6	280.590 6
1/16	0.062 5	1.587 5	26.987 5	52.387 5	77.787 5	103.187 5	128.587 5	153.987 5	179.387 5	204.787 5	230.187 5	255.587 5	280.987 5
5/64	0.078 125	1.984 4	27.384 4	52.784 4	78.184 4	103.584 4	128.984 4	154.384 4	179.784 4	205.184 4	230.584 4	255.984 4	281.384 4
3/32	0.093 75	2.381 2	27.781 2	53.181 2	78.581 2	103.981 2	129.381 2	154.781 2	180.181 2	205.581 2	230.981 2	256.381 2	281.781 2
7/64	0.109 375	2.778 1	28.178 1	53.578 1	78.978 1	104.378 1	129.778 1	155.178 1	180.578 1	205.978 1	231.378 1	256.778 1	282.178 1
1/8	0.125	3.175 0	28.575 0	53.975 0	79.375 0	104.775 0	130.175 0	155.575 0	180.975 0	206.375 0	231.775 0	257.175 0	282.575 0
9/64	0.140 625	3.571 9	28.971 9	54.371 9	79.771 9	105.171 9	130.571 9	155.971 9	181.371 9	206.771 9	232.171 9	257.571 9	282.971 9
5/32	0.156 25	3.968 8	29.368 8	54.768 8	80.168 8	105.568 8	130.968 8	156.368 8	181.768 8	207.168 8	232.568 8	257.968 8	283.368 8
11/64	0.171 875	4.365 6	29.765 6	55.165 6	80.565 6	105.965 6	131.365 6	156.765 6	182.165 6	207.565 6	232.965 6	258.365 6	283.765 6
3/16	0.187 5	4.762 5	30.162 5	55.562 5	80.962 5	106.362 5	131.762 5	157.162 5	182.562 5	207.962 5	233.362 5	258.762 5	284.162 5
13/64	0.203 125	5.159 4	30.559 4	55.959 4	81.359 4	106.759 4	132.159 4	157.559 4	182.959 4	208.359 4	233.759 4	259.159 4	284.559 4
7/32	0.218 75	5.556 2	30.956 2	56.356 2	81.756 2	107.156 2	132.556 2	157.956 2	183.356 2	208.756 2	234.156 2	259.556 2	284.956 2
15/64	0.234 375	5.953 1	31.353 1	56.753 1	82.153 1	107.553 1	132.953 1	158.353 1	183.753 1	209.153 1	234.553 1	259.953 1	285.353 1
1/4	0.25	6.350 0	31.750 0	57.150 0	82.550 0	107.950 0	133.350 0	158.750 0	184.150 0	209.550 0	234.950 0	260.350 0	285.750 0
17/64	0.265 625	6.746 9	32.146 9	57.546 9	82.946 9	108.346 9	133.746 9	159.146 9	184.546 9	209.946 9	235.346 9	260.746 9	286.146 9
9/32	0.281 25	7.143 8	32.543 8	57.943 8	83.343 8	108.743 8	134.143 8	159.543 8	184.943 8	210.343 8	235.743 8	261.143 8	286.543 8
19/64	0.296 875	7.540 6	32.940 6	58.340 6	83.740 6	109.140 6	134.540 6	159.940 6	185.340 6	210.740 6	236.140 6	261.540 6	286.940 6
5/16	0.312 5	7.937 5	33.337 5	58.737 5	84.137 5	109.537 5	134.937 5	160.337 5	185.737 5	211.137 5	236.537 5	261.937 5	287.337 5
21/64	0.328 125	8.334 4	33.734 4	59.134 4	84.534 4	109.934 4	135.334 4	160.734 4	186.134 4	211.534 4	236.934 4	262.334 4	287.734 4
11/32	0.343 75	8.731 2	34.131 2	59.531 2	84.931 2	110.331 2	135.731 2	161.131 2	186.531 2	211.931 2	237.331 2	262.731 2	288.131 2
23/64	0.359 375	9.128 1	34.528 1	59.928 1	85.328 1	110.728 1	136.128 1	161.528 1	186.928 1	212.328 1	237.728 1	263.128 1	288.528 1
3/8	0.375	9.525 0	34.925 0	60.325 0	85.725 0	111.125 0	136.525 0	161.925 0	187.325 0	212.725 0	238.125 0	263.525 0	288.925 0
25/64	0.390 625	9.921 9	35.321 9	60.721 9	86.121 9	111.521 9	136.921 9	162.321 9	187.721 9	213.121 9	238.521 9	263.921 9	289.321 9
13/32	0.406 25	10.318 8	35.718 8	61.118 8	86.518 8	111.918 8	137.318 8	162.718 8	188.118 8	213.518 8	238.918 8	264.318 8	289.718 8
27/64	0.421 875	10.715 6	36.115 6	61.515 6	86.915 6	112.315 6	137.715 6	163.115 6	188.515 6	213.915 6	239.315 6	264.715 6	290.115 6
7/16	0.437 5	11.112 5	36.512 5	61.912 5	87.312 5	112.712 5	138.112 5	163.512 5	188.912 5	214.312 5	239.712 5	265.112 5	290.512 5
29/64	0.453 125	11.509 4	36.909 4	62.309 4	87.709 4	113.109 4	138.509 4	163.909 4	189.309 4	214.709 4	240.109 4	265.509 4	290.909 4
15/32	0.468 75	11.906 2	37.306 2	62.706 2	88.106 2	113.506 2	138.906 2	164.306 2	189.706 2	215.106 2	240.506 2	265.906 2	291.306 2
31/64	0.484 375	12.303 1	37.703 1	63.103 1	88.503 1	113.903 1	139.303 1	164.703 1	190.103 1	215.503 1	240.903 1	266.303 1	291.703 1
1/2	0.5	12.700 0	38.100 0	63.500 0	88.900 0	114.300 0	139.700 0	165.100 0	190.500 0	215.900 0	241.300 0	266.700 0	292.100 0
33/64	0.515 625	13.096 9	38.496 9	63.896 9	89.296 9	114.696 9	140.096 9	165.496 9	190.896 9	216.296 9	241.696 9	267.096 9	292.496 9
17/32	0.531 25	13.493 8	38.893 8	64.293 8	89.693 8	115.093 8	140.493 8	165.893 8	191.293 8	216.693 8	242.093 8	267.493 8	292.893 8
35/64	0.546 875	13.890 6	39.290 6	64.690 6	90.090 6	115.490 6	140.890 6	166.290 6	191.690 6	217.090 6	242.490 6	267.890 6	293.290 6
9/16	0.562 5	14.287 5	39.687 5	65.087 5	90.487 5	115.887 5	141.287 5	166.687 5	192.087 5	217.487 5	242.887 5	268.287 5	293.687 5
37/64	0.578 125	14.684 4	40.084 4	65.484 4	90.884 4	116.284 4	141.684 4	167.084 4	192.484 4	217.884 4	243.284 4	268.684 4	294.084 4
19/32	0.593 75	15.081 2	40.481 2	65.881 2	91.281 2	116.681 2	142.081 2	167.481 2	192.881 2	218.281 2	243.681 2	269.081 2	294.481 2
39/64	0.609 375	15.478 1	40.878 1	66.278 1	91.678 1	117.078 1	142.478 1	167.878 1	193.278 1	218.678 1	244.078 1	269.478 1	294.878 1
5/8	0.625	15.875 0	41.275 0	66.675 0	92.075 0	117.475 0	142.875 0	168.275 0	193.675 0	219.075 0	244.475 0	269.875 0	295.275 0
41/64	0.640 625	16.271 9	41.671 9	67.071 9	92.471 9	117.871 9	143.271 9	168.671 9	194.071 9	219.471 9	244.871 9	270.271 9	295.671 9
21/32	0.656 25	16.668 8	42.068 8	67.468 8	92.868 8	118.268 8	143.668 8	169.068 8	194.468 8	219.868 8	245.268 8	270.668 8	296.068 8
43/64	0.671 875	17.065 6	42.465 6	67.865 6	93.265 6	118.665 6	144.065 6	169.465 6	194.865 6	220.265 6	245.665 6	271.065 6	296.465 6
11/16	0.687 5	17.462 5	42.862 5	68.262 5	93.662 5	119.062 5	144.462 5	169.862 5	195.262 5	220.662 5	246.062 5	271.462 5	296.862 5
45/64	0.703 125	17.859 4	43.259 4	68.659 4	94.059 4	119.459 4	144.859 4	170.259 4	195.659 4	221.062 5	246.459 4	271.859 4	297.259 4
23/32	0.718 75	18.256 2	43.656 2	69.056 2	94.456 2	119.856 2	145.256 2	170.656 2	196.056 2	221.456 2	246.856 2	272.256 2	297.656 2
47/64	0.734 375	18.653 1	44.053 1	69.453 1	94.853 1	120.253 1	145.653 1	171.053 1	196.453 1	221.853 1	247.253 1	272.653 1	298.053 1
3/4	0.75	19.050 0	44.450 0	69.850 0	95.250 0	120.650 0	146.050 0	171.450 0	196.850 0	222.250 0	247.650 0	273.050 0	298.450 0
49/64	0.765 625	19.446 9	44.846 9	70.246 9	95.646 9	121.046 9	146.446 9	171.846 9	197.246 9	222.646 9	248.046 9	273.446 9	298.846 9
25/32	0.781 25	19.843 8	45.243 8	70.643 8	96.043 8	121.443 8	146.843 8	172.243 8	197.643 8	223.043 8	248.443 8	273.843 8	299.243 8
51/64	0.796 875	20.240 6	45.640 6	71.040 6	96.440 6	121.840 6	147.240 6	172.640 6	198.040 6	223.440 6	248.840 6	274.240 6	299.640 6
13/16	0.812 5	20.637 5	46.037 5	71.437 5	96.837 5	122.237 5	147.637 5	173.037 5	198.437 5	223.837 5	249.237 5	274.637 5	300.037 5
53/64	0.828 125	21.034 4	46.434 4	71.834 4	97.234 4	122.634 4	148.034 4	173.434 4	198.834 4	224.234 4	249.634 4	275.034 4	300.434 4
27/32	0.843 75	21.431 2	46.831 2	72.231 2	97.631 2	123.031 2	148.431 2	173.831 2	199.231 2	224.631 2	250.031 2	275.431 2	300.831 2
55/64	0.859 375	21.828 1	47.228 1	72.628 1	98.028 1	123.428 1	148.828 1	174.228 1	199.628 1	225.028 1	250.428 1	275.828 1	301.228 1
7/8	0.875	22.225 0	47.625 0	73.025 0	98.425 0	123.825 0	149.225 0	174.625 0	200.025 0	225.425 0	250.825 0	276.225 0	301.625 0
57/64	0.890 625	22.621 9	48.021 9	73.421 9	98.821 9	124.221 9	149.621 9	175.021 9	200.421 9	225.821 9	251.221 9	276.621 9	302.021 9
29/32	0.906 25	23.018 8	48.418 8	73.818 8	99.218 8	124.618 8	1						

KALİTE GÜVENCE TESTLERİ / QUALITY ASSURANCE TEST





YASAL UYARILAR / LEGAL NOTIE

Bu katalog, önceki baskıların yerine geçer.

Katalog içeriğinde yer alan ürünlerin teknik özellikleri, görünümü, ölçüleri mevcut şartları temsil etmektedir. Firmanın, gerektiğinde ürünlerle ilgili değişiklik yapma hakkı saklıdır.

Ürün kataloğu ve içeriğindeki tüm görsellerin telif hakkı İZELTAŞ İzmir El Aletleri Sanayi ve Ticaret A.Ş.'ye aittir. İzinsiz kullanılması ve çoğaltılması yasaktır.

Kullanıcı, katalogdaki ürünlerle ilgili güvenlik uyarılarına uymakla yükümlüdür. Bu uyarılara uyulmaması durumunda ortaya çıkacak zararlardan firma sorumlu tutulamaz.

Grafik Tasarım ve Düzenleme

İZELTAŞ İzmir El Aletleri Sanayi ve Ticaret A.Ş.

This catalogue replaces previous editions.

Technical features, appearance and measurements of the products included in the catalogue represent the current conditions. The company reserves the right to make changes to the products if necessary.

The copyright of the product catalogue and all the images in the content belong to İZELTAŞ İzmir El Aletleri Sanayi ve Ticaret A.Ş.

Unauthorised use and reproduction is prohibited.

The user is obliged to comply with the safety instructions for the products in the catalogue. The company shall not be liable for any damages resulting from failure to comply with these instructions.

Graphic Design and Editing

İZELTAŞ İzmir El Aletleri Sanayi ve Ticaret A.Ş.

KOD	ÜRÜN	FİYAT	SAYFA
0100002108	İKİ AĞIZ ANAHTAR TAKIMI KISA BOY 8 PARÇA	140,35	41
0100002112	İKİ AĞIZ ANAHTAR TAKIMI KISA BOY 12 PARÇA	271,60	41
0100010405	İKİ AĞIZ ANAHTAR KISA BOY 04X05	12,20	41
0100010607	İKİ AĞIZ ANAHTAR KISA BOY 06X07	12,45	41
0100010608	İKİ AĞIZ ANAHTAR KISA BOY 06X08	12,45	41
0100010708	İKİ AĞIZ ANAHTAR KISA BOY 07X08	12,80	41
0100010709	İKİ AĞIZ ANAHTAR KISA BOY 07X09	12,80	41
0100010809	İKİ AĞIZ ANAHTAR KISA BOY 08X09	12,80	41
0100010810	İKİ AĞIZ ANAHTAR KISA BOY 08X10	13,05	41
0100010910	İKİ AĞIZ ANAHTAR KISA BOY 09X10	13,05	41
0100010911	İKİ AĞIZ ANAHTAR KISA BOY 09X11	13,95	41
0100011011	İKİ AĞIZ ANAHTAR KISA BOY 10X11	13,95	41
0100011012	İKİ AĞIZ ANAHTAR KISA BOY 10X12	13,95	41
0100011013	İKİ AĞIZ ANAHTAR KISA BOY 10X13	14,95	41
0100011014	İKİ AĞIZ ANAHTAR KISA BOY 10X14	14,95	41
0100011113	İKİ AĞIZ ANAHTAR KISA BOY 11X13	15,35	41
0100011114	İKİ AĞIZ ANAHTAR KISA BOY 11X14	15,35	41
0100011213	İKİ AĞIZ ANAHTAR KISA BOY 12X13	15,35	41
0100011214	İKİ AĞIZ ANAHTAR KISA BOY 12X14	15,35	41
0100011314	İKİ AĞIZ ANAHTAR KISA BOY 13X14	15,35	41
0100011315	İKİ AĞIZ ANAHTAR KISA BOY 13X15	17,75	41
0100011317	İKİ AĞIZ ANAHTAR KISA BOY 13X17	20,20	41
0100011415	İKİ AĞIZ ANAHTAR KISA BOY 14X15	17,75	41
0100011417	İKİ AĞIZ ANAHTAR KISA BOY 14X17	20,75	41
0100011617	İKİ AĞIZ ANAHTAR KISA BOY 16X17	20,75	41
0100011719	İKİ AĞIZ ANAHTAR KISA BOY 17X19	22,20	41
0100011722	İKİ AĞIZ ANAHTAR KISA BOY 17X22	25,10	41
0100011819	İKİ AĞIZ ANAHTAR KISA BOY 18X19	22,20	41
0100011820	İKİ AĞIZ ANAHTAR KISA BOY 18x20	25,10	41
0100011822	İKİ AĞIZ ANAHTAR KISA BOY 18X22	25,10	41
0100011922	İKİ AĞIZ ANAHTAR KISA BOY 19X22	25,10	41
0100011924	İKİ AĞIZ ANAHTAR KISA BOY 19X24	26,25	41
0100012022	İKİ AĞIZ ANAHTAR KISA BOY 20X22	25,10	41
0100012123	İKİ AĞIZ ANAHTAR KISA BOY 21X23	26,25	41
0100012224	İKİ AĞIZ ANAHTAR KISA BOY 22X24	27,40	41
0100012226	İKİ AĞIZ ANAHTAR KISA BOY 22X26	28,20	41
0100012227	İKİ AĞIZ ANAHTAR KISA BOY 22X27	28,20	41
0100012426	İKİ AĞIZ ANAHTAR KISA BOY 24X26	28,20	41
0100012427	İKİ AĞIZ ANAHTAR KISA BOY 24X27	28,20	41
0100012430	İKİ AĞIZ ANAHTAR KISA BOY 24X30	41,75	41
0100012528	İKİ AĞIZ ANAHTAR KISA BOY 25X28	35,05	41
0100012730	İKİ AĞIZ ANAHTAR KISA BOY 27X30	41,75	41
0100012732	İKİ AĞIZ ANAHTAR KISA BOY 27X32	41,75	41
0100013032	İKİ AĞIZ ANAHTAR KISA BOY 30X32	41,75	41
0130002108	İKİ AĞIZ ANAHTAR TAKIMI UZUN BOY 8 PARÇA	173,35	42
0130002112	İKİ AĞIZ ANAHTAR TAKIMI UZUN BOY 12 PARÇA	333,20	42
0130010555	İKİ AĞIZ ANAHTAR UZUN BOY 05X5,5	12,45	42
0130010607	İKİ AĞIZ ANAHTAR UZUN BOY 06X07	15,90	42
0130010608	İKİ AĞIZ ANAHTAR UZUN BOY 06X08	16,45	42
0130010708	İKİ AĞIZ ANAHTAR UZUN BOY 07X08	16,45	42
0130010709	İKİ AĞIZ ANAHTAR UZUN BOY 07X09	16,45	42
0130010809	İKİ AĞIZ ANAHTAR UZUN BOY 08X09	16,45	42
0130010810	İKİ AĞIZ ANAHTAR UZUN BOY 08X10	16,45	42
0130010910	İKİ AĞIZ ANAHTAR UZUN BOY 09X10	18,20	42
0130010911	İKİ AĞIZ ANAHTAR UZUN BOY 09X11	18,20	42
0130011011	İKİ AĞIZ ANAHTAR UZUN BOY 10X11	18,20	42
0130011012	İKİ AĞIZ ANAHTAR UZUN BOY 10X12	18,20	42
0130011013	İKİ AĞIZ ANAHTAR UZUN BOY 10X13	18,20	42
0130011014	İKİ AĞIZ ANAHTAR UZUN BOY 10X14	18,20	42
0130011113	İKİ AĞIZ ANAHTAR UZUN BOY 11X13	18,20	42
0130011114	İKİ AĞIZ ANAHTAR UZUN BOY 11X14	18,20	42
0130011213	İKİ AĞIZ ANAHTAR UZUN BOY 12X13	19,15	42
0130011214	İKİ AĞIZ ANAHTAR UZUN BOY 12X14	19,15	42
0130011314	İKİ AĞIZ ANAHTAR UZUN BOY 13X14	19,15	42
0130011315	İKİ AĞIZ ANAHTAR UZUN BOY 13x15	19,15	42
0130011317	İKİ AĞIZ ANAHTAR UZUN BOY 13X17	24,30	42
0130011415	İKİ AĞIZ ANAHTAR UZUN BOY 14X15	22,25	42

KOD	ÜRÜN	FİYAT	SAYFA
0130011417	İKİ AĞIZ ANAHTAR UZUN BOY 14X17	24,30	42
0130011617	İKİ AĞIZ ANAHTAR UZUN BOY 16X17	24,60	42
0130011618	İKİ AĞIZ ANAHTAR UZUN BOY 16X18	26,25	42
0130011719	İKİ AĞIZ ANAHTAR UZUN BOY 17X19	26,25	42
0130011722	İKİ AĞIZ ANAHTAR UZUN BOY 17X22	30,55	42
0130011724	İKİ AĞIZ ANAHTAR UZUN BOY 17X24	30,70	42
0130011819	İKİ AĞIZ ANAHTAR UZUN BOY 18X19	26,25	42
0130011921	İKİ AĞIZ ANAHTAR UZUN BOY 19X21	30,55	42
0130011922	İKİ AĞIZ ANAHTAR UZUN BOY 19X22	30,55	42
0130011924	İKİ AĞIZ ANAHTAR UZUN BOY 19X24	30,70	42
0130012022	İKİ AĞIZ ANAHTAR UZUN BOY 20x22	30,55	42
0130012123	İKİ AĞIZ ANAHTAR UZUN BOY 21X23	31,15	42
0130012224	İKİ AĞIZ ANAHTAR UZUN BOY 22X24	32,00	42
0130012227	İKİ AĞIZ ANAHTAR UZUN BOY 22X27	36,60	42
0130012426	İKİ AĞIZ ANAHTAR UZUN BOY 24X26	36,60	42
0130012427	İKİ AĞIZ ANAHTAR UZUN BOY 24X27	36,60	42
0130012430	İKİ AĞIZ ANAHTAR UZUN BOY 24X30	40,95	42
0130012528	İKİ AĞIZ ANAHTAR UZUN BOY 25X28	40,95	42
0130012729	İKİ AĞIZ ANAHTAR UZUN BOY 27X29	51,15	42
0130012730	İKİ AĞIZ ANAHTAR UZUN BOY 27X30	51,15	42
0130012732	İKİ AĞIZ ANAHTAR UZUN BOY 27X32	51,15	42
0130013032	İKİ AĞIZ ANAHTAR UZUN BOY 30X32	51,15	42
0130013036	İKİ AĞIZ ANAHTAR UZUN BOY 30X36	97,00	42
0130013236	İKİ AĞIZ ANAHTAR UZUN BOY 32X36	97,00	42
0130013436	İKİ AĞIZ ANAHTAR UZUN BOY 34X36	97,00	42
0130013641	İKİ AĞIZ ANAHTAR UZUN BOY 36X41	150,70	42
0130014146	İKİ AĞIZ ANAHTAR UZUN BOY 41X46	232,35	42
0130014650	İKİ AĞIZ ANAHTAR UZUN BOY 46X50	257,70	42
0132011415	İKİ AĞIZ ANAHTAR UZUN BOY MASTER 14X15	23,90	43
0132011819	İKİ AĞIZ ANAHTAR UZUN BOY MASTER 18X19	28,10	43
0132012528	İKİ AĞIZ ANAHTAR UZUN BOY MASTER 25X28	43,90	43
0132012732	İKİ AĞIZ ANAHTAR UZUN BOY MASTER 27X32	54,70	43
0150002108	ELTA İKİ AĞIZ ANAHTAR TAKIMI 8 PARÇA	116,95	182
0150002112	ELTA İKİ AĞIZ ANAHTAR TAKIMI 12 PARÇA	231,00	182
0150010607	ELTA İKİ AĞIZ ANAHTAR 06X07 MM	10,50	182
0150010809	ELTA İKİ AĞIZ ANAHTAR 08X09 MM	10,65	182
0150011011	ELTA İKİ AĞIZ ANAHTAR 10X11 MM	11,55	182
0150011213	ELTA İKİ AĞIZ ANAHTAR 12X13 MM	12,80	182
0150011415	ELTA İKİ AĞIZ ANAHTAR 14X15 MM	14,85	182
0150011617	ELTA İKİ AĞIZ ANAHTAR 16X17 MM	17,20	182
0150011819	ELTA İKİ AĞIZ ANAHTAR 18X19 MM	18,45	182
0150012022	ELTA İKİ AĞIZ ANAHTAR 20X22 MM	20,95	182
0150012123	ELTA İKİ AĞIZ ANAHTAR 21X23 MM	22,85	182
0150012426	ELTA İKİ AĞIZ ANAHTAR 24X26 MM	24,50	182
0150012528	ELTA İKİ AĞIZ ANAHTAR 25X28 MM	30,40	182
0150012732	ELTA İKİ AĞIZ ANAHTAR 27X32 MM	36,30	182
0161002108	İKİ AĞIZ ANAHTAR TAKIMI UZUN BOY (SAE) 8 PARÇA	230,25	43
0161002112	İKİ AĞIZ ANAHTAR TAKIMI UZUN BOY (SAE) 12 PARÇA	410,10	43
0161010608	İKİ AĞIZ ANAHTAR UZUN BOY 1/4x 5/16 (SAE)	19,70	43
0161010809	İKİ AĞIZ ANAHTAR UZUN BOY 5/16x3/8 (SAE)	19,70	43
0161010810	İKİ AĞIZ ANAHTAR UZUN BOY 5/16x11/32 (SAE)	19,70	43
0161010811	İKİ AĞIZ ANAHTAR UZUN BOY 5/16x7/16 (SAE)	19,70	43
0161010911	İKİ AĞIZ ANAHTAR UZUN BOY 3/8x7/16 (SAE)	21,85	43
0161011112	İKİ AĞIZ ANAHTAR UZUN BOY 7/16x1/2 (SAE)	21,85	43
0161011214	İKİ AĞIZ ANAHTAR UZUN BOY 1/2x9/16 (SAE)	23,00	43
0161011416	İKİ AĞIZ ANAHTAR UZUN BOY 9/16x5/8 (SAE)	26,75	43
0161011417	İKİ AĞIZ ANAHTAR UZUN BOY 9/16x11/16 (SAE)	29,15	43
0161011517	İKİ AĞIZ ANAHTAR UZUN BOY 19/32x11/16 (SAE)	29,45	43
0161011619	İKİ AĞIZ ANAHTAR UZUN BOY 5/8x3/4 (SAE)	31,50	43
0161011920	İKİ AĞIZ ANAHTAR UZUN BOY 3/4x25/32 (SAE)	31,50	43
0161011922	İKİ AĞIZ ANAHTAR UZUN BOY 3/4x7/8 (SAE)	36,60	43
0161012021	İKİ AĞIZ ANAHTAR UZUN BOY 25/32x13/16 (SAE)	36,60	43
0161012122	İKİ AĞIZ ANAHTAR UZUN BOY 13/16x7/8 (SAE)	37,30	43
0161012325	İKİ AĞIZ ANAHTAR UZUN BOY 15/16x1 (SAE)	44,00	43
0161012328	İKİ AĞIZ ANAHTAR UZUN BOY 15/16x1 1/8 (SAE)	44,50	43
0161012628	İKİ AĞIZ ANAHTAR UZUN BOY 1 1/16x1 1/8 (SAE)	63,90	43
0161012631	İKİ AĞIZ ANAHTAR UZUN BOY 1 1/16x1 1/4 (SAE)	67,50	43

KOD	ÜRÜN	FİYAT	SAYFA	KOD	ÜRÜN	FİYAT	SAYFA
0161012833	İKİ AĞIZ ANAHTAR UZUN BOY 1 1/8x1 5/16 (SAE)	67,50	43	0322020011	KOMBİNE ANAHTAR KISA BOY MASTER 11 MM	22,20	47
0220011722	İKİ AĞIZ TAÇLI ANAHTAR 17X22	26,35	43	0322020012	KOMBİNE ANAHTAR KISA BOY MASTER 12 MM	23,65	47
0250010021	BİR AĞIZ TAÇLI ANAHTAR 21 MM	0,00	44	0322020014	KOMBİNE ANAHTAR KISA BOY MASTER 14 MM	26,25	47
0250010022	BİR AĞIZ TAÇLI ANAHTAR 22 MM	0,00	44	0322020015	KOMBİNE ANAHTAR KISA BOY MASTER 15 MM	28,00	47
0250010023	BİR AĞIZ TAÇLI ANAHTAR 23 MM	0,00	44	0322020016	KOMBİNE ANAHTAR KISA BOY MASTER 16 MM	30,00	47
0250010024	BİR AĞIZ TAÇLI ANAHTAR 24 MM	0,00	44	0322020017	KOMBİNE ANAHTAR KISA BOY MASTER 17 MM	32,10	47
0250010025	BİR AĞIZ TAÇLI ANAHTAR 25 MM	0,00	44	0322020018	KOMBİNE ANAHTAR KISA BOY MASTER 18 MM	35,70	47
0250010027	BİR AĞIZ TAÇLI ANAHTAR 27 MM	0,00	44	0322020019	KOMBİNE ANAHTAR KISA BOY MASTER 19 MM	37,50	47
0250010030	BİR AĞIZ TAÇLI ANAHTAR 30 MM	73,20	44	0322020020	KOMBİNE ANAHTAR KISA BOY MASTER 20 MM	38,15	47
0250010032	BİR AĞIZ TAÇLI ANAHTAR 32 MM	0,00	44	0322020021	KOMBİNE ANAHTAR KISA BOY MASTER 21 MM	44,50	47
0250010034	BİR AĞIZ TAÇLI ANAHTAR 34 MM	0,00	44	0322020022	KOMBİNE ANAHTAR KISA BOY MASTER 22 MM	50,90	47
0250010036	BİR AĞIZ TAÇLI ANAHTAR 36 MM	92,40	44	0322020024	KOMBİNE ANAHTAR KISA BOY MASTER 24 MM	55,95	47
0250010038	BİR AĞIZ TAÇLI ANAHTAR 38 MM	0,00	44	0322020025	KOMBİNE ANAHTAR KISA BOY MASTER 25 MM	61,50	47
0250010041	BİR AĞIZ TAÇLI ANAHTAR 41 MM	120,65	44	0322020026	KOMBİNE ANAHTAR KISA BOY MASTER 26 MM	67,65	47
0250010046	BİR AĞIZ TAÇLI ANAHTAR 46 MM	129,85	44	0322020030	KOMBİNE ANAHTAR KISA BOY MASTER 30 MM	81,15	47
0250010050	BİR AĞIZ TAÇLI ANAHTAR 50 MM	162,15	44	0325020010	MONTAJ ANAHTAR 10 MM	27,40	44
0250010055	BİR AĞIZ TAÇLI ANAHTAR 55 MM	217,25	44	0325020013	MONTAJ ANAHTAR 13 MM	30,70	44
0250010060	BİR AĞIZ TAÇLI ANAHTAR 60 MM	278,20	44	0325020017	MONTAJ ANAHTAR 17 MM	40,60	44
0250010065	BİR AĞIZ TAÇLI ANAHTAR 65 MM	339,15	44	0325020019	MONTAJ ANAHTAR 19 MM	47,55	44
0250010070	BİR AĞIZ TAÇLI ANAHTAR 70 MM	0,00	44	0325020020	MONTAJ ANAHTAR 20 MM	48,45	44
0250010075	BİR AĞIZ TAÇLI ANAHTAR 75 MM	0,00	44	0325020021	MONTAJ ANAHTAR 21 MM	56,30	44
0255010010	SÜPER İZOLE ÇATAL BİR AĞIZ ANAHTAR 10 MM	42,80	44	0325020022	MONTAJ ANAHTAR 22 MM	64,50	44
0255010011	SÜPER İZOLE ÇATAL BİR AĞIZ ANAHTAR 11 MM	45,20	44	0330002108	KOMBİNE ANAHTAR TAKIMI UZUN BOY 8 PARÇA	211,40	46
0255010012	SÜPER İZOLE ÇATAL BİR AĞIZ ANAHTAR 12 MM	47,20	44	0330002112	KOMBİNE ANAHTAR TAKIMI UZUN BOY 12 PARÇA	376,20	46
0255010013	SÜPER İZOLE ÇATAL BİR AĞIZ ANAHTAR 13 MM	50,80	44	0330002117	KOMBİNE ANAHTAR TAKIMI UZUN BOY 17 PARÇA	545,55	46
0255010014	SÜPER İZOLE ÇATAL BİR AĞIZ ANAHTAR 14 MM	52,75	44	0330002121	KOMBİNE ANAHTAR TAKIMI UZUN BOY 21 PARÇA	892,40	46
0255010017	SÜPER İZOLE ÇATAL BİR AĞIZ ANAHTAR 17 MM	64,75	44	0330020005	KOMBİNE ANAHTAR UZUN BOY 05 MM	18,35	46
0255010019	SÜPER İZOLE ÇATAL BİR AĞIZ ANAHTAR 19 MM	76,00	44	0330020006	KOMBİNE ANAHTAR UZUN BOY 06 MM	18,35	46
0255010022	SÜPER İZOLE ÇATAL BİR AĞIZ ANAHTAR 22 MM	102,20	44	0330020007	KOMBİNE ANAHTAR UZUN BOY 07 MM	18,35	46
0255010024	SÜPER İZOLE ÇATAL BİR AĞIZ ANAHTAR 24 MM	125,05	44	0330020008	KOMBİNE ANAHTAR UZUN BOY 08 MM	21,45	46
0320002108	KOMBİNE ANAHTAR TAKIMI KISA BOY 8 PARÇA	189,90	45	0330020009	KOMBİNE ANAHTAR UZUN BOY 09 MM	21,75	46
0320002112	KOMBİNE ANAHTAR TAKIMI KISA BOY 12 PARÇA	339,75	45	0330020010	KOMBİNE ANAHTAR UZUN BOY 10 MM	24,05	46
0320002117	KOMBİNE ANAHTAR TAKIMI KISA BOY 17 PARÇA	494,20	45	0330020011	KOMBİNE ANAHTAR UZUN BOY 11 MM	25,40	46
0320002121	KOMBİNE ANAHTAR TAKIMI KISA BOY 21 PARÇA	806,55	45	0330020012	KOMBİNE ANAHTAR UZUN BOY 12 MM	25,40	46
0320020005	KOMBİNE ANAHTAR KISA BOY 05 MM	15,90	45	0330020013	KOMBİNE ANAHTAR UZUN BOY 13 MM	28,50	46
0320020006	KOMBİNE ANAHTAR KISA BOY 06 MM	16,45	45	0330020014	KOMBİNE ANAHTAR UZUN BOY 14 MM	29,65	46
0320020007	KOMBİNE ANAHTAR KISA BOY 07 MM	17,50	45	0330020015	KOMBİNE ANAHTAR UZUN BOY 15 MM	31,65	46
0320020008	KOMBİNE ANAHTAR KISA BOY 08 MM	19,05	45	0330020016	KOMBİNE ANAHTAR UZUN BOY 16 MM	32,00	46
0320020009	KOMBİNE ANAHTAR KISA BOY 09 MM	19,50	45	0330020017	KOMBİNE ANAHTAR UZUN BOY 17 MM	36,35	46
0320020010	KOMBİNE ANAHTAR KISA BOY 10 MM	22,00	45	0330020018	KOMBİNE ANAHTAR UZUN BOY 18 MM	39,20	46
0320020011	KOMBİNE ANAHTAR KISA BOY 11 MM	22,55	45	0330020019	KOMBİNE ANAHTAR UZUN BOY 19 MM	42,60	46
0320020012	KOMBİNE ANAHTAR KISA BOY 12 MM	24,05	45	0330020020	KOMBİNE ANAHTAR UZUN BOY 20 MM	45,30	46
0320020013	KOMBİNE ANAHTAR KISA BOY 13 MM	24,60	45	0330020021	KOMBİNE ANAHTAR UZUN BOY 21 MM	48,15	46
0320020014	KOMBİNE ANAHTAR KISA BOY 14 MM	26,60	45	0330020022	KOMBİNE ANAHTAR UZUN BOY 22 MM	57,40	46
0320020015	KOMBİNE ANAHTAR KISA BOY 15 MM	28,45	45	0330020023	KOMBİNE ANAHTAR UZUN BOY 23 MM	70,10	46
0320020016	KOMBİNE ANAHTAR KISA BOY 16 MM	30,55	45	0330020024	KOMBİNE ANAHTAR UZUN BOY 24 MM	70,10	46
0320020017	KOMBİNE ANAHTAR KISA BOY 17 MM	32,55	45	0330020025	KOMBİNE ANAHTAR UZUN BOY 25 MM	70,10	46
0320020018	KOMBİNE ANAHTAR KISA BOY 18 MM	36,35	45	0330020026	KOMBİNE ANAHTAR UZUN BOY 26 MM	82,55	46
0320020019	KOMBİNE ANAHTAR KISA BOY 19 MM	38,25	45	0330020027	KOMBİNE ANAHTAR UZUN BOY 27 MM	82,55	46
0320020020	KOMBİNE ANAHTAR KISA BOY 20 MM	38,95	45	0330020028	KOMBİNE ANAHTAR UZUN BOY 28 MM	82,55	46
0320020021	KOMBİNE ANAHTAR KISA BOY 21 MM	45,20	45	0330020029	KOMBİNE ANAHTAR UZUN BOY 29 MM	82,55	46
0320020022	KOMBİNE ANAHTAR KISA BOY 22 MM	51,60	45	0330020030	KOMBİNE ANAHTAR UZUN BOY 30 MM	94,80	46
0320020023	KOMBİNE ANAHTAR KISA BOY 23 MM	51,60	45	0330020032	KOMBİNE ANAHTAR UZUN BOY 32 MM	99,40	46
0320020024	KOMBİNE ANAHTAR KISA BOY 24 MM	63,15	45	0330020034	KOMBİNE ANAHTAR UZUN BOY 34 MM	101,35	46
0320020025	KOMBİNE ANAHTAR KISA BOY 25 MM	63,15	45	0330020036	KOMBİNE ANAHTAR UZUN BOY 36 MM	114,80	46
0320020026	KOMBİNE ANAHTAR KISA BOY 26 MM	74,40	45	0330020038	KOMBİNE ANAHTAR UZUN BOY 38 MM	117,50	46
0320020027	KOMBİNE ANAHTAR KISA BOY 27 MM	74,40	45	0330020041	KOMBİNE ANAHTAR UZUN BOY 41 MM	133,70	46
0320020028	KOMBİNE ANAHTAR KISA BOY 28 MM	74,40	45	0330020046	KOMBİNE ANAHTAR UZUN BOY 46 MM	181,65	46
0320020029	KOMBİNE ANAHTAR KISA BOY 29 MM	85,20	45	0330020050	KOMBİNE ANAHTAR UZUN BOY 50 MM	246,35	46
0320020030	KOMBİNE ANAHTAR KISA BOY 30 MM	85,20	45	0330020055	KOMBİNE ANAHTAR UZUN BOY 5,5 MM	18,35	46
0320020032	KOMBİNE ANAHTAR KISA BOY 32 MM	89,60	45	0331002108	KOMBİNE ANAHTAR TAKIMI UZUN BOY 8 PARÇA (SAE)	305,30	47
0320020034	KOMBİNE ANAHTAR KISA BOY 34 MM	93,60	45	0331002112	KOMBİNE ANAHTAR TAKIMI UZUN BOY 12 PARÇA (SAE)	619,40	47
0320020055	KOMBİNE ANAHTAR KISA BOY 05,5 MM	15,90	45	0331002117	KOMBİNE ANAHTAR TAKIMI UZUN BOY 17 PARÇA (SAE)	963,30	47
0322020006	KOMBİNE ANAHTAR KISA BOY MASTER 06 MM	16,10	47	0331002120	KOMBİNE ANAHTAR TAKIMI UZUN BOY 20 PARÇA (SAE)	1.317,85	47
0322020007	KOMBİNE ANAHTAR KISA BOY MASTER 07 MM	17,15	47	0331020005	KOMBİNE ANAHTAR UZUN BOY 3/16 (SAE)	22,00	47
0322020008	KOMBİNE ANAHTAR KISA BOY MASTER 08 MM	18,55	47	0331020006	KOMBİNE ANAHTAR UZUN BOY 1/4 (SAE)	22,90	47
0322020009	KOMBİNE ANAHTAR KISA BOY MASTER 09 MM	19,20	47	0331020008	KOMBİNE ANAHTAR UZUN BOY 5/16 (SAE)	26,65	47

KOD	ÜRÜN	FİYAT	SAYFA	KOD	ÜRÜN	FİYAT	SAYFA
0331020010	KOMBİNE ANAHTAR UZUN BOY 3/8 (SAE)	30,40	47	0350020014	ELTA KOMBİNE ANAHTAR 14 MM	22,10	183
0331020011	KOMBİNE ANAHTAR UZUN BOY 7/16 (SAE)	31,90	47	0350020015	ELTA KOMBİNE ANAHTAR 15 MM	23,70	183
0331020013	KOMBİNE ANAHTAR UZUN BOY 1/2 (SAE)	36,00	47	0350020016	ELTA KOMBİNE ANAHTAR 16 MM	25,40	183
0331020014	KOMBİNE ANAHTAR UZUN BOY 9/16 (SAE)	37,85	47	0350020017	ELTA KOMBİNE ANAHTAR 17 MM	27,25	183
0331020015	KOMBİNE ANAHTAR UZUN BOY 19/32 (SAE)	40,10	47	0350020018	ELTA KOMBİNE ANAHTAR 18 MM	30,20	183
0331020016	KOMBİNE ANAHTAR UZUN BOY 5/8 (SAE)	43,10	47	0350020019	ELTA KOMBİNE ANAHTAR 19 MM	31,85	183
0331020017	KOMBİNE ANAHTAR UZUN BOY 11/16 (SAE)	45,90	47	0350020020	ELTA KOMBİNE ANAHTAR 20 MM	32,40	183
0331020019	KOMBİNE ANAHTAR UZUN BOY 3/4 (SAE)	53,50	47	0350020021	ELTA KOMBİNE ANAHTAR 21 MM	37,70	183
0331020020	KOMBİNE ANAHTAR UZUN BOY 25/32 (SAE)	57,25	47	0350020022	ELTA KOMBİNE ANAHTAR 22 MM	43,10	183
0331020021	KOMBİNE ANAHTAR UZUN BOY 13/16 (SAE)	63,20	47	0350020024	ELTA KOMBİNE ANAHTAR 24 MM	52,60	183
0331020022	KOMBİNE ANAHTAR UZUN BOY 7/8 (SAE)	72,80	47	0350020027	ELTA KOMBİNE ANAHTAR 27 MM	62,00	183
0331020024	KOMBİNE ANAHTAR UZUN BOY 15/16 (SAE)	89,05	47	0350020030	ELTA KOMBİNE ANAHTAR 30 MM	71,15	183
0331020025	KOMBİNE ANAHTAR UZUN BOY 1 " (SAE)	89,05	47	0350020032	ELTA KOMBİNE ANAHTAR 32 MM	74,60	183
0331020027	KOMBİNE ANAHTAR UZUN BOY 1 1/16 (SAE)	104,25	47	0360020008	EXTRA UZUN KOMBİNE ANAHTAR 08 MM	21,90	49
0331020028	KOMBİNE ANAHTAR UZUN BOY 1 1/8 (SAE)	104,25	47	0360020009	EXTRA UZUN KOMBİNE ANAHTAR 09 MM	22,20	49
0331020030	KOMBİNE ANAHTAR UZUN BOY 1 3/16 (SAE)	119,40	47	0360020010	EXTRA UZUN KOMBİNE ANAHTAR 10 MM	24,75	49
0331020032	KOMBİNE ANAHTAR UZUN BOY 1 1/4 (SAE)	125,15	47	0360020011	EXTRA UZUN KOMBİNE ANAHTAR 11 MM	26,00	49
0331020033	KOMBİNE ANAHTAR UZUN BOY 1 5/16 (SAE)	125,15	47	0360020012	EXTRA UZUN KOMBİNE ANAHTAR 12 MM	26,00	49
0331020035	KOMBİNE ANAHTAR UZUN BOY 1 3/8 (SAE)	137,55	47	0360020014	EXTRA UZUN KOMBİNE ANAHTAR 14 MM	30,45	49
0331020036	KOMBİNE ANAHTAR UZUN BOY 1 7/16 (SAE)	137,55	47	0360020015	EXTRA UZUN KOMBİNE ANAHTAR 15 MM	32,45	49
0331020038	KOMBİNE ANAHTAR UZUN BOY 1 1/2 (SAE)	151,30	47	0360020016	EXTRA UZUN KOMBİNE ANAHTAR 16 MM	32,95	49
0331020041	KOMBİNE ANAHTAR UZUN BOY 1 5/8 (SAE)	160,35	47	0360020018	EXTRA UZUN KOMBİNE ANAHTAR 18 MM	40,40	49
0331020046	KOMBİNE ANAHTAR UZUN BOY 1 13/16 (SAE)	218,00	47	0360020020	EXTRA UZUN KOMBİNE ANAHTAR 20 MM	46,70	49
0331020050	KOMBİNE ANAHTAR UZUN BOY 2" (SAE)	295,55	47	0360020030	EXTRA UZUN KOMBİNE ANAHTAR 30 MM	97,45	49
0335020010	ÇOKLU YILDIZ CIRCİR ANAHTAR 10x13x17x19	244,80	48	0360020032	EXTRA UZUN KOMBİNE ANAHTAR 32 MM	116,15	49
0340002110	CIRCİR KOMBİNE ANAHTAR TAKIMI 10 PARÇA	789,45	48	0360020034	EXTRA UZUN KOMBİNE ANAHTAR 34 MM	118,50	49
0340002115	CIRCİR KOMBİNE ANAHTAR TAKIMI 15 PARÇA	1.539,35	48	0360020041	EXTRA UZUN KOMBİNE ANAHTAR 41 MM	187,65	49
0340020008	CIRCİR KOMBİNE ANAHTAR 08 MM	63,65	48	0360020046	EXTRA UZUN KOMBİNE ANAHTAR 46 MM	218,65	49
0340020009	CIRCİR KOMBİNE ANAHTAR 09 MM	63,65	48	0370002108	BOYUNLU KOMBİNE ANAHTAR TAKIMI 8 PARÇA	218,65	50
0340020010	CIRCİR KOMBİNE ANAHTAR 10 MM	65,80	48	0370002112	BOYUNLU KOMBİNE ANAHTAR TAKIMI 12 PARÇA	391,55	50
0340020011	CIRCİR KOMBİNE ANAHTAR 11 MM	66,15	48	0370002117	BOYUNLU KOMBİNE ANAHTAR TAKIMI 17 PARÇA	570,55	50
0340020012	CIRCİR KOMBİNE ANAHTAR 12 MM	71,65	48	0370002121	BOYUNLU KOMBİNE ANAHTAR TAKIMI 21 PARÇA	930,15	50
0340020013	CIRCİR KOMBİNE ANAHTAR 13 MM	76,80	48	0370020006	BOYUNLU KOMBİNE ANAHTAR 06 MM	18,90	50
0340020014	CIRCİR KOMBİNE ANAHTAR 14 MM	79,10	48	0370020007	BOYUNLU KOMBİNE ANAHTAR 07 MM	20,15	50
0340020015	CIRCİR KOMBİNE ANAHTAR 15 MM	83,85	48	0370020008	BOYUNLU KOMBİNE ANAHTAR 08 MM	21,85	50
0340020016	CIRCİR KOMBİNE ANAHTAR 16 MM	96,10	48	0370020009	BOYUNLU KOMBİNE ANAHTAR 09 MM	22,35	50
0340020017	CIRCİR KOMBİNE ANAHTAR 17 MM	101,70	48	0370020010	BOYUNLU KOMBİNE ANAHTAR 10 MM	25,30	50
0340020018	CIRCİR KOMBİNE ANAHTAR 18 MM	110,25	48	0370020011	BOYUNLU KOMBİNE ANAHTAR 11 MM	26,05	50
0340020019	CIRCİR KOMBİNE ANAHTAR 19 MM	117,10	48	0370020012	BOYUNLU KOMBİNE ANAHTAR 12 MM	27,95	50
0340020021	CIRCİR KOMBİNE ANAHTAR 21 MM	162,95	48	0370020013	BOYUNLU KOMBİNE ANAHTAR 13 MM	28,65	50
0340020022	CIRCİR KOMBİNE ANAHTAR 22 MM	178,70	48	0370020014	BOYUNLU KOMBİNE ANAHTAR 14 MM	30,70	50
0340020024	CIRCİR KOMBİNE ANAHTAR 24 MM	201,90	48	0370020015	BOYUNLU KOMBİNE ANAHTAR 15 MM	32,65	50
0345002112	MAFSALLI CIRCİR KOMBİNE ANAHTAR TAKIMI 12 PARÇA	1.544,35	49	0370020016	BOYUNLU KOMBİNE ANAHTAR 16 MM	35,10	50
0345020008	MAFSALLI CIRCİR KOMBİNE ANAHTAR 08 MM	101,05	49	0370020017	BOYUNLU KOMBİNE ANAHTAR 17 MM	37,45	50
0345020009	MAFSALLI CIRCİR KOMBİNE ANAHTAR 09 MM	103,05	49	0370020018	BOYUNLU KOMBİNE ANAHTAR 18 MM	41,80	50
0345020010	MAFSALLI CIRCİR KOMBİNE ANAHTAR 10 MM	107,20	49	0370020019	BOYUNLU KOMBİNE ANAHTAR 19 MM	44,00	50
0345020011	MAFSALLI CIRCİR KOMBİNE ANAHTAR 11 MM	110,55	49	0370020020	BOYUNLU KOMBİNE ANAHTAR 20 MM	46,20	50
0345020012	MAFSALLI CIRCİR KOMBİNE ANAHTAR 12 MM	116,85	49	0370020021	BOYUNLU KOMBİNE ANAHTAR 21 MM	51,95	50
0345020013	MAFSALLI CIRCİR KOMBİNE ANAHTAR 13 MM	121,90	49	0370020022	BOYUNLU KOMBİNE ANAHTAR 22 MM	59,50	50
0345020014	MAFSALLI CIRCİR KOMBİNE ANAHTAR 14 MM	128,20	49	0370020023	BOYUNLU KOMBİNE ANAHTAR 23 MM	72,70	50
0345020015	MAFSALLI CIRCİR KOMBİNE ANAHTAR 15 MM	134,50	49	0370020024	BOYUNLU KOMBİNE ANAHTAR 24 MM	72,70	50
0345020016	MAFSALLI CIRCİR KOMBİNE ANAHTAR 16 MM	146,35	49	0370020025	BOYUNLU KOMBİNE ANAHTAR 25 MM	72,70	50
0345020017	MAFSALLI CIRCİR KOMBİNE ANAHTAR 17 MM	148,25	49	0370020026	BOYUNLU KOMBİNE ANAHTAR 26 MM	85,55	50
0345020018	MAFSALLI CIRCİR KOMBİNE ANAHTAR 18 MM	159,65	49	0370020027	BOYUNLU KOMBİNE ANAHTAR 27 MM	85,55	50
0345020019	MAFSALLI CIRCİR KOMBİNE ANAHTAR 19 MM	166,80	49	0370020028	BOYUNLU KOMBİNE ANAHTAR 28 MM	85,55	50
0350002108	ELTA KOMBİNE ANAHTAR TAKIMI 8 PARÇA	158,25	183	0370020029	BOYUNLU KOMBİNE ANAHTAR 29 MM	95,30	50
0350002112	ELTA KOMBİNE ANAHTAR TAKIMI 12 PARÇA	283,35	183	0370020030	BOYUNLU KOMBİNE ANAHTAR 30 MM	98,25	50
0350002117	ELTA KOMBİNE ANAHTAR TAKIMI 17 PARÇA	411,90	183	0370020032	BOYUNLU KOMBİNE ANAHTAR 32 MM	103,10	50
0350002121	ELTA KOMBİNE ANAHTAR TAKIMI 21 PARÇA	672,25	183	0370020036	BOYUNLU KOMBİNE ANAHTAR 36 MM	119,15	50
0350020006	ELTA KOMBİNE ANAHTAR 06 MM	13,70	183	0375050020	KABLO SIYIRICI KANCA BIÇAKLI Ø8 - 28	105,30	155
0350020007	ELTA KOMBİNE ANAHTAR 07 MM	14,55	183	0375150012	KOAKSİYEL KABLO SIYIRICI (DIŞ 1-İÇ 2)	136,70	155
0350020008	ELTA KOMBİNE ANAHTAR 08 MM	15,75	183	0375250625	KABLO SIYIRICI (TEKLİ 6/300 - ÇOKLU 1,5/25)	95,80	155
0350020009	ELTA KOMBİNE ANAHTAR 09 MM	16,30	183	0375350054	MEKANİK KABLO SIYIRICI 0,5MM-4 MM	180,15	155
0350020010	ELTA KOMBİNE ANAHTAR 10 MM	18,35	183	0375550625	KABLO SIYIRICI YEDEK BIÇAĞI	26,05	201
0350020011	ELTA KOMBİNE ANAHTAR 11 MM	18,90	183	0380002108	TORX KOMBİNE ANAHTAR TAKIMI 8 PARÇA	403,45	51
0350020012	ELTA KOMBİNE ANAHTAR 12 MM	20,15	183	0380002112	TORX KOMBİNE ANAHTAR TAKIMI 12 PARÇA	692,35	51
0350020013	ELTA KOMBİNE ANAHTAR 13 MM	20,50	183	0380020008	TORX KOMBİNE ANAHTAR 08 MM	38,10	51

KOD	ÜRÜN	FİYAT	SAYFA	KOD	ÜRÜN	FİYAT	SAYFA
0380020009	TORX KOMBİNE ANAHTAR 09 MM	38,70	51	0431031920	YILDIZ İKİ AĞIZ ANAHTAR 3/4x25/32 (SAE)	64,50	53
0380020010	TORX KOMBİNE ANAHTAR 10 MM	42,90	51	0431031922	YILDIZ İKİ AĞIZ ANAHTAR 3/4x7/8 (SAE)	67,70	53
0380020011	TORX KOMBİNE ANAHTAR 11 MM	45,25	51	0431032021	YILDIZ İKİ AĞIZ ANAHTAR 25/32x13/16 (SAE)	67,70	53
0380020012	TORX KOMBİNE ANAHTAR 12 MM	46,45	51	0431032122	YILDIZ İKİ AĞIZ ANAHTAR 13/16x7/8 (SAE)	77,60	53
0380020013	TORX KOMBİNE ANAHTAR 13 MM	51,00	51	0431032223	YILDIZ İKİ AĞIZ ANAHTAR 7/8x15/16 (SAE)	77,60	53
0380020014	TORX KOMBİNE ANAHTAR 14 MM	56,40	51	0431032325	YILDIZ İKİ AĞIZ ANAHTAR 15/16x1 (SAE)	90,45	53
0380020015	TORX KOMBİNE ANAHTAR 15 MM	59,70	51	0431032328	YILDIZ İKİ AĞIZ ANAHTAR 15/16x1 1/8 (SAE)	90,45	53
0380020017	TORX KOMBİNE ANAHTAR 17 MM	64,85	51	0431032528	YILDIZ İKİ AĞIZ ANAHTAR 1x1 1/8 (SAE)	99,00	53
0380020018	TORX KOMBİNE ANAHTAR 18 MM	70,35	51	0431032631	YILDIZ İKİ AĞIZ ANAHTAR 1 1/16x1 1/4 (SAE)	109,00	53
0380020019	TORX KOMBİNE ANAHTAR 19 MM	76,20	51	0431032833	YILDIZ İKİ AĞIZ ANAHTAR 1 1/8x1 5/16 (SAE)	109,00	53
0380020022	TORX KOMBİNE ANAHTAR 22 MM	102,45	51	0431033033	YILDIZ İKİ AĞIZ ANAHTAR 1 3/16x1 5/16 (SAE)	116,25	53
0430002108	YILDIZ İKİ AĞIZ ANAHTAR TAKIMI 8 PARÇA	315,25	52	0431033036	YILDIZ İKİ AĞIZ ANAHTAR 1 3/16 x1 3/8 (SAE)	168,00	53
0430002112	YILDIZ İKİ AĞIZ ANAHTAR TAKIMI 12 PARÇA	628,80	52	0431033236	YILDIZ İKİ AĞIZ ANAHTAR 1 1/4x1 7/16 (SAE)	168,00	53
0430030607	YILDIZ İKİ AĞIZ ANAHTAR 06X07	28,50	52	0431033641	YILDIZ İKİ AĞIZ ANAHTAR 1 7/16x1 5/8 (SAE)	228,35	53
0430030809	YILDIZ İKİ AĞIZ ANAHTAR 08X09	28,90	52	0431034146	YILDIZ İKİ AĞIZ ANAHTAR 1 11/16x1 7/8 (SAE)	312,75	53
0430030810	YILDIZ İKİ AĞIZ ANAHTAR 08X10	28,90	52	0431034650	YILDIZ İKİ AĞIZ ANAHTAR 1 13/16x2 (SAE)	497,65	53
0430031011	YILDIZ İKİ AĞIZ ANAHTAR 10X11	32,00	52	0432030607	YILDIZ İKİ AĞIZ ANAHTAR MASTER 06X07	26,90	53
0430031012	YILDIZ İKİ AĞIZ ANAHTAR 10X12	32,00	52	0432031819	YILDIZ İKİ AĞIZ ANAHTAR MASTER 18X19	48,60	53
0430031013	YILDIZ İKİ AĞIZ ANAHTAR 10X13	36,35	52	0432032528	YILDIZ İKİ AĞIZ ANAHTAR MASTER 25X28	77,90	53
0430031014	YILDIZ İKİ AĞIZ ANAHTAR 10X14	36,35	52	0432032732	YILDIZ İKİ AĞIZ ANAHTAR MASTER 27X32	85,75	53
0430031113	YILDIZ İKİ AĞIZ ANAHTAR 11X13	36,35	52	0435030010	SÜPER İZOLELİ BİR AĞIZ YILDIZ ANAHTAR 10 MM	57,05	55
0430031213	YILDIZ İKİ AĞIZ ANAHTAR 12X13	36,35	52	0435030011	SÜPER İZOLELİ BİR AĞIZ YILDIZ ANAHTAR 11 MM	57,05	55
0430031214	YILDIZ İKİ AĞIZ ANAHTAR 12X14	36,35	52	0435030012	SÜPER İZOLELİ BİR AĞIZ YILDIZ ANAHTAR 12 MM	64,75	55
0430031315	YILDIZ İKİ AĞIZ ANAHTAR 13X15	38,25	52	0435030013	SÜPER İZOLELİ BİR AĞIZ YILDIZ ANAHTAR 13 MM	64,75	55
0430031317	YILDIZ İKİ AĞIZ ANAHTAR 13X17	43,30	52	0435030014	SÜPER İZOLELİ BİR AĞIZ YILDIZ ANAHTAR 14 MM	67,95	55
0430031415	YILDIZ İKİ AĞIZ ANAHTAR 14X15	38,25	52	0435030017	SÜPER İZOLELİ BİR AĞIZ YILDIZ ANAHTAR 17 MM	77,00	55
0430031417	YILDIZ İKİ AĞIZ ANAHTAR 14X17	43,30	52	0435030019	SÜPER İZOLELİ BİR AĞIZ YILDIZ ANAHTAR 19 MM	91,85	55
0430031617	YILDIZ İKİ AĞIZ ANAHTAR 16X17	43,30	52	0435030022	SÜPER İZOLELİ BİR AĞIZ YILDIZ ANAHTAR 22 MM	100,70	55
0430031618	YILDIZ İKİ AĞIZ ANAHTAR 16x18	51,45	52	0435030024	SÜPER İZOLELİ BİR AĞIZ YILDIZ ANAHTAR 24 MM	134,55	55
0430031719	YILDIZ İKİ AĞIZ ANAHTAR 17X19	51,45	52	0440002108	DÜZ YILDIZ ANAHTAR TAKIMI 8 PARÇA	302,75	54
0430031819	YILDIZ İKİ AĞIZ ANAHTAR 18X19	51,45	52	0440002112	DÜZ YILDIZ ANAHTAR TAKIMI 12 PARÇA	606,10	54
0430031922	YILDIZ İKİ AĞIZ ANAHTAR 19X22	56,50	52	0440030607	DÜZ YILDIZ ANAHTAR 06X07	26,25	54
0430031924	YILDIZ İKİ AĞIZ ANAHTAR 19X24	56,50	52	0440030809	DÜZ YILDIZ ANAHTAR 08X09	27,40	54
0430032022	YILDIZ İKİ AĞIZ ANAHTAR 20X22	56,50	52	0440030810	DÜZ YILDIZ ANAHTAR 08X10	29,35	54
0430032123	YILDIZ İKİ AĞIZ ANAHTAR 21X23	64,75	52	0440031011	DÜZ YILDIZ ANAHTAR 10X11	30,40	54
0430032224	YILDIZ İKİ AĞIZ ANAHTAR 22X24	64,75	52	0440031013	DÜZ YILDIZ ANAHTAR 10X13	32,80	54
0430032227	YILDIZ İKİ AĞIZ ANAHTAR 22X27	75,45	52	0440031213	DÜZ YILDIZ ANAHTAR 12X13	32,80	54
0430032426	YILDIZ İKİ AĞIZ ANAHTAR 24x26	75,45	52	0440031315	DÜZ YILDIZ ANAHTAR 13X15	38,25	54
0430032427	YILDIZ İKİ AĞIZ ANAHTAR 24X27	75,45	52	0440031317	DÜZ YILDIZ ANAHTAR 13X17	45,30	54
0430032430	YILDIZ İKİ AĞIZ ANAHTAR 24X30	82,55	52	0440031415	DÜZ YILDIZ ANAHTAR 14X15	38,25	54
0430032528	YILDIZ İKİ AĞIZ ANAHTAR 25X28	82,55	52	0440031617	DÜZ YILDIZ ANAHTAR 16X17	45,30	54
0430032729	YILDIZ İKİ AĞIZ ANAHTAR 27X29	90,80	52	0440031618	DÜZ YILDIZ ANAHTAR 16X18	47,35	54
0430032730	YILDIZ İKİ AĞIZ ANAHTAR 27X30	90,80	52	0440031719	DÜZ YILDIZ ANAHTAR 17X19	47,35	54
0430032732	YILDIZ İKİ AĞIZ ANAHTAR 27X32	90,80	52	0440031819	DÜZ YILDIZ ANAHTAR 18X19	47,35	54
0430033032	YILDIZ İKİ AĞIZ ANAHTAR 30X32	90,80	52	0440032022	DÜZ YILDIZ ANAHTAR 20X22	55,00	54
0430033034	YILDIZ İKİ AĞIZ ANAHTAR 30X34	120,70	52	0440032123	DÜZ YILDIZ ANAHTAR 21X23	65,15	54
0430033036	YILDIZ İKİ AĞIZ ANAHTAR 30X36	140,05	52	0440032224	DÜZ YILDIZ ANAHTAR 22X24	65,15	54
0430033236	YILDIZ İKİ AĞIZ ANAHTAR 32X36	140,05	52	0440032426	DÜZ YILDIZ ANAHTAR 24X26	65,95	54
0430033436	YILDIZ İKİ AĞIZ ANAHTAR 34X36	171,20	52	0440032427	DÜZ YILDIZ ANAHTAR 24X27	65,95	54
0430033641	YILDIZ İKİ AĞIZ ANAHTAR 36X41	190,25	52	0440032528	DÜZ YILDIZ ANAHTAR 25X28	77,05	54
0430034146	YILDIZ İKİ AĞIZ ANAHTAR 41X46	260,70	52	0440032729	DÜZ YILDIZ ANAHTAR 27X29	88,05	54
0430034650	YILDIZ İKİ AĞIZ ANAHTAR 46X50	414,80	52	0440032732	DÜZ YILDIZ ANAHTAR 27X32	95,20	54
0431002108	YILDIZ İKİ AĞIZ ANAHTAR TAKIMI 8 PARÇA (SAE)	446,20	53	0440033032	DÜZ YILDIZ ANAHTAR 30X32	95,20	54
0431002112	YILDIZ İKİ AĞIZ ANAHTAR TAKIMI 12 PARÇA (SAE)	820,80	53	0450002108	ELTA YILDIZ İKİ AĞIZ ANAHTAR TAKIMI 8 PARÇA	260,85	184
0431030608	YILDIZ İKİ AĞIZ ANAHTAR 1/4x 5/16 (SAE)	35,25	53	0450002112	ELTA YILDIZ İKİ AĞIZ ANAHTAR TAKIMI 12 PARÇA	520,35	184
0431030809	YILDIZ İKİ AĞIZ ANAHTAR 5/16x 3/8 (SAE)	36,60	53	0450030607	ELTA YILDIZ İKİ AĞIZ ANAHTAR 06X07 MM	23,65	184
0431030811	YILDIZ İKİ AĞIZ ANAHTAR 5/16 x 7/16 (SAE)	38,35	53	0450030809	ELTA YILDIZ İKİ AĞIZ ANAHTAR 08X09 MM	23,95	184
0431030911	YILDIZ İKİ AĞIZ ANAHTAR 3/8x 7/16 (SAE)	40,35	53	0450031011	ELTA YILDIZ İKİ AĞIZ ANAHTAR 10X11 MM	26,60	184
0431031112	YILDIZ İKİ AĞIZ ANAHTAR 7/16x1/2 (SAE)	43,55	53	0450031213	ELTA YILDIZ İKİ AĞIZ ANAHTAR 12X13 MM	30,05	184
0431031214	YILDIZ İKİ AĞIZ ANAHTAR 1/2x9/16 (SAE)	45,90	53	0450031415	ELTA YILDIZ İKİ AĞIZ ANAHTAR 14X15 MM	31,55	184
0431031217	YILDIZ İKİ AĞIZ ANAHTAR 1/2x11/16 (SAE)	51,95	53	0450031617	ELTA YILDIZ İKİ AĞIZ ANAHTAR 16X17 MM	35,70	184
0431031415	YILDIZ İKİ AĞIZ ANAHTAR 9/16x19/32 (SAE)	45,90	53	0450031819	ELTA YILDIZ İKİ AĞIZ ANAHTAR 18X19 MM	42,65	184
0431031416	YILDIZ İKİ AĞIZ ANAHTAR 9/16x5/8 (SAE)	46,30	53	0450032022	ELTA YILDIZ İKİ AĞIZ ANAHTAR 20X22 MM	46,70	184
0431031417	YILDIZ İKİ AĞIZ ANAHTAR 9/16x11/16 (SAE)	51,95	53	0450032123	ELTA YILDIZ İKİ AĞIZ ANAHTAR 21X23 MM	53,55	184
0431031517	YILDIZ İKİ AĞIZ ANAHTAR 19/32x11/16 (SAE)	51,95	53	0450032426	ELTA YILDIZ İKİ AĞIZ ANAHTAR 24X26 MM	62,35	184
0431031617	YILDIZ İKİ AĞIZ ANAHTAR 5/8x11/16 (SAE)	51,95	53	0450032528	ELTA YILDIZ İKİ AĞIZ ANAHTAR 25X28 MM	68,35	184
0431031619	YILDIZ İKİ AĞIZ ANAHTAR 5/8x3/4 (SAE)	61,90	53	0450032732	ELTA YILDIZ İKİ AĞIZ ANAHTAR 27X32 MM	75,25	184

KOD	ÜRÜN	FİYAT	SAYFA
0530040810	YARIM AY ANAHTAR YILDIZ İKİ AĞIZ 08x10 MM	33,80	55
0530041011	YARIM AY ANAHTAR YILDIZ İKİ AĞIZ 10x11 MM	39,70	55
0530041012	YARIM AY ANAHTAR YILDIZ İKİ AĞIZ 10x12 MM	39,70	55
0530041113	YARIM AY ANAHTAR YILDIZ İKİ AĞIZ 11x13 MM	39,70	55
0530041315	YARIM AY ANAHTAR YILDIZ İKİ AĞIZ 13x15 MM	47,30	55
0530041317	YARIM AY ANAHTAR YILDIZ İKİ AĞIZ 13x17 MM	47,30	55
0530041417	YARIM AY ANAHTAR YILDIZ İKİ AĞIZ 14x17 MM	47,30	55
0530041517	YARIM AY ANAHTAR YILDIZ İKİ AĞIZ 15x17 MM	47,30	55
0530041922	YARIM AY ANAHTAR YILDIZ İKİ AĞIZ 19x22 MM	61,55	55
0531040809	YARIM AY ANAHTAR YILDIZ İKİ AĞIZ 5/16 X3/8 (SAE)	40,50	55
0531040911	YARIM AY ANAHTAR YILDIZ İKİ AĞIZ 3/8 X7/16 (SAE)	47,65	55
0531041112	YARIM AY ANAHTAR YILDIZ İKİ AĞIZ 7/16x1/2 (SAE)	48,95	55
0531041214	YARIM AY ANAHTAR YILDIZ İKİ AĞIZ 1/2x9/16 (SAE)	56,90	55
0531041416	YARIM AY ANAHTAR YILDIZ İKİ AĞIZ 9/16x5/8 (SAE)	58,65	55
0531041417	YARIM AY ANAHTAR YILDIZ İKİ AĞIZ 9/16x11/16 (SAE)	56,70	55
0531041922	YARIM AY ANAHTAR YILDIZ İKİ AĞIZ 3/4x7/8 (SAE)	73,90	55
0540010810	RAKOR ANAHTAR 08x10 MM	48,70	55
0540011011	RAKOR ANAHTAR 10x11 MM	50,55	55
0540011012	RAKOR ANAHTAR 10x12 MM	50,55	55
0540011113	RAKOR ANAHTAR 11x13 MM	54,15	55
0540011214	RAKOR ANAHTAR 12x14 MM	54,15	55
0540011719	RAKOR ANAHTAR 17x19 MM	96,65	55
0540011922	RAKOR ANAHTAR 19x22 MM	115,75	55
0550050022	BORU UZATMALI YILDIZ ANAHTAR 22 MM	0,00	57
0550050024	BORU UZATMALI YILDIZ ANAHTAR 24 MM	99,90	57
0550050027	BORU UZATMALI YILDIZ ANAHTAR 27 MM	119,05	57
0550050030	BORU UZATMALI YILDIZ ANAHTAR 30 MM	142,20	57
0550050032	BORU UZATMALI YILDIZ ANAHTAR 32 MM	163,30	57
0550050034	BORU UZATMALI YILDIZ ANAHTAR 34 MM	0,00	57
0550050036	BORU UZATMALI YILDIZ ANAHTAR 36 MM	184,75	57
0550050038	BORU UZATMALI YILDIZ ANAHTAR 38 MM	213,15	57
0550050041	BORU UZATMALI YILDIZ ANAHTAR 41 MM	241,45	57
0550050046	BORU UZATMALI YILDIZ ANAHTAR 46 MM	288,95	57
0550050050	BORU UZATMALI YILDIZ ANAHTAR 50 MM	341,15	57
0550050055	BORU UZATMALI YILDIZ ANAHTAR 55 MM	479,80	57
0550050060	BORU UZATMALI YILDIZ ANAHTAR 60 MM	520,75	57
0550050065	BORU UZATMALI YILDIZ ANAHTAR 65 MM	563,80	57
0550050070	BORU UZATMALI YILDIZ ANAHTAR 70 MM	0,00	57
0550050075	BORU UZATMALI YILDIZ ANAHTAR 75 MM	0,00	57
0550050080	BORU UZATMALI YILDIZ ANAHTAR 80 MM	0,00	57
0550050085	BORU UZATMALI YILDIZ ANAHTAR 85 MM	0,00	57
0550050090	BORU UZATMALI YILDIZ ANAHTAR 90 MM	0,00	57
0550050095	BORU UZATMALI YILDIZ ANAHTAR 95 MM	0,00	57
0550050100	BORU UZATMALI YILDIZ ANAHTAR 100 MM	0,00	57
0551050001	DÖNDÜRME KOLU BORUSU 22-30 MM	88,70	57
0551050002	DÖNDÜRME KOLU BORUSU 32-41 MM	120,20	57
0551050003	DÖNDÜRME KOLU BORUSU 46-55 MM	180,20	57
0551050004	DÖNDÜRME KOLU BORUSU 60-100 MM	243,20	57
0588050040	SU TERAZİSİ 40 CM	106,20	156
0588050050	SU TERAZİSİ 50 CM	115,25	156
0588050060	SU TERAZİSİ 60 CM	125,25	156
0588050070	SU TERAZİSİ 70 CM	134,50	156
0588050080	SU TERAZİSİ 80 CM	145,30	156
0588050100	SU TERAZİSİ 100 CM	165,40	156
0588050120	SU TERAZİSİ 120 CM	195,75	156
0588050150	SU TERAZİSİ 150 CM	225,55	156
0588050200	SU TERAZİSİ 200 CM	315,10	156
0588150003	PLASTİK ŞERİT METRE 3 M	39,70	155
0588150005	PLASTİK ŞERİT METRE 5 M	47,70	155
0588150013	KROM ŞERİT METRE 3 M	47,30	155
0588150015	KROM ŞERİT METRE 5 M	53,40	155
0588650020	ARAZİ TİPİ FİBERGLAS ŞERİT METRE SAPLI 20 M	110,60	156
0588650030	ARAZİ TİPİ FİBERGLAS ŞERİT METRE SAPLI 30 M	118,10	156
0588650050	ARAZİ TİPİ FİBERGLAS ŞERİT METRE SAPLI 50 M	189,70	156
0588750150	KUMPAS 150 MM	391,95	156
0589050830	TESTERE KOLU 30 CM	149,60	156
0589550150	KİL TESTERE KOLU (AĞAÇ SAPLI) 150 MM	32,55	156

KOD	ÜRÜN	FİYAT	SAYFA
0589850283	HSS TESTERE LAMASI 13x0.65x18	17,00	202
0589950283	BİMETAL TESTERE LAMASI 13x0.65x18	20,95	202
0590150020	SENTİL 0.05-1 MM 20 PARÇA	36,35	157
0590250020	SENTİL SAE 2-35/1000"	56,85	157
0600010206	6" KURBAGACIK YEDEK PARÇASI SOMUN	6,75	200
0600010208	8" KURBAGACIK YEDEK PARÇASI SOMUN	8,00	200
0600010210	10" KURBAGACIK YEDEK PARÇASI SOMUN	10,65	200
0600010212	12" KURBAGACIK YEDEK PARÇASI SOMUN	14,60	200
0600010215	15" KURBAGACIK YEDEK PARÇASI SOMUN	21,05	200
0600010306	6" KURBAGACIK YEDEK PARÇASI VİDA	1,60	200
0600010308	8" KURBAGACIK YEDEK PARÇASI VİDA	2,55	200
0600010310	10" KURBAGACIK YEDEK PARÇASI VİDA	3,15	200
0600010312	12" KURBAGACIK YEDEK PARÇASI VİDA	4,20	200
0600010315	15" KURBAGACIK YEDEK PARÇASI VİDA	5,35	200
0600010406	6" KURBAGACIK YEDEK PARÇASI YAY	1,20	200
0600010408	8" KURBAGACIK YEDEK PARÇASI YAY	1,20	200
0600010410	10" KURBAGACIK YEDEK PARÇASI YAY	1,20	200
0600010412	12" KURBAGACIK YEDEK PARÇASI YAY	1,20	200
0600010415	15" KURBAGACIK YEDEK PARÇASI YAY	1,20	200
0600011006	KURBAĞACIK ANAHTAR 6"	88,75	57
0600011008	KURBAĞACIK ANAHTAR 8"	114,90	57
0600011010	KURBAĞACIK ANAHTAR 10"	148,10	57
0600011012	KURBAĞACIK ANAHTAR 12"	204,70	57
0600011015	KURBAĞACIK ANAHTAR 15"	320,85	57
0601010008	ELTA KURBAĞACIK ANAHTAR 8"	81,75	185
0601010010	ELTA KURBAĞACIK ANAHTAR 10"	123,05	185
0601010012	ELTA KURBAĞACIK ANAHTAR 12"	157,00	185
0615010200	AYARLI MONTAJ ANAHTARI 200 MM	143,25	58
0637350140	KAYIŞLI YAĞ FİLTRESİ SÖKECEĞİ 60x140 MM	194,40	160
0637450140	ZİNCİRLİ YAĞ FİLTRESİ SÖKECEĞİ 60x140 MM	156,35	160
0637550010	AYARLI YAĞ FİLTRE SÖKECEĞİ YEDEK KELEPÇE	21,10	201
0637550100	AYARLI YAĞ FİLTRESİ SÖKECEĞİ 100 MM	85,75	160
0637650108	SAC YAĞ FİLTRESİ SÖKECEĞİ	52,85	160
0639050125	SEGMAN ÇEMBERİ 125 mm	154,75	161
0639050175	SEGMAN ÇEMBERİ 175 mm	316,35	161
0676050042	PLASTİK BORU KESME MAKASI 42 MM	410,75	171
0676050063	PLASTİK BORU KESME MAKASI 63 MM	720,75	171
0676550042	42 MM PLASTİK BORU KESME MAKASI YEDEK BİÇAK	232,90	202
0676550063	63 MM PLASTİK BORU KESME MAKASI YEDEK BİÇAK	432,65	202
0700050024	ÇATAL ÇAKMA ANAHTAR 24 MM	68,20	56
0700050027	ÇATAL ÇAKMA ANAHTAR 27 MM	84,65	56
0700050030	ÇATAL ÇAKMA ANAHTAR 30 MM	104,00	56
0700050032	ÇATAL ÇAKMA ANAHTAR 32 MM	116,75	56
0700050036	ÇATAL ÇAKMA ANAHTAR 36 MM	131,10	56
0700050038	ÇATAL ÇAKMA ANAHTAR 38 MM	157,80	56
0700050041	ÇATAL ÇAKMA ANAHTAR 41 MM	171,35	56
0700050042	ÇATAL ÇAKMA ANAHTAR 42 MM	198,00	56
0700050046	ÇATAL ÇAKMA ANAHTAR 46 MM	217,90	56
0700050047	ÇATAL ÇAKMA ANAHTAR 47 MM	254,50	56
0700050050	ÇATAL ÇAKMA ANAHTAR 50 MM	272,30	56
0700050055	ÇATAL ÇAKMA ANAHTAR 55 MM	365,00	56
0700050060	ÇATAL ÇAKMA ANAHTAR 60 MM	396,25	56
0700050065	ÇATAL ÇAKMA ANAHTAR 65 MM	570,00	56
0700050070	ÇATAL ÇAKMA ANAHTAR 70 MM	729,70	56
0700050075	ÇATAL ÇAKMA ANAHTAR 75 MM	773,10	56
0700050080	ÇATAL ÇAKMA ANAHTAR 80 MM	983,20	56
0700050085	ÇATAL ÇAKMA ANAHTAR 85 MM	1.303,35	56
0700050090	ÇATAL ÇAKMA ANAHTAR 90 MM	1.341,00	56
0700050095	ÇATAL ÇAKMA ANAHTAR 95 MM	1.430,05	56
0700050100	ÇATAL ÇAKMA ANAHTAR 100 MM	2.026,85	56
0700050105	ÇATAL ÇAKMA ANAHTAR 105 MM	2.090,05	56
0700050110	ÇATAL ÇAKMA ANAHTAR 110 MM	2.384,85	56
0700050115	ÇATAL ÇAKMA ANAHTAR 115 MM	2.739,60	56
0700050120	ÇATAL ÇAKMA ANAHTAR 120 MM	2.891,75	56
0700050125	ÇATAL ÇAKMA ANAHTAR 125 MM	0,00	56
0700050130	ÇATAL ÇAKMA ANAHTAR 130 MM	0,00	56
0700050135	ÇATAL ÇAKMA ANAHTAR 135 MM	0,00	56

KOD	ÜRÜN	FİYAT	SAYFA	KOD	ÜRÜN	FİYAT	SAYFA
0700050140	ÇATAL ÇAKMA ANAHTAR 140 MM	0,00	56	1107060005	1/4" ALTI KÖŞE 05 MM LOKMA ANAHTAR	5,50	65
0700050145	ÇATAL ÇAKMA ANAHTAR 145 MM	0,00	56	1107060006	1/4" ALTI KÖŞE 06 MM LOKMA ANAHTAR	5,50	65
0700050150	ÇATAL ÇAKMA ANAHTAR 150 MM	0,00	56	1107060007	1/4" ALTI KÖŞE 07 MM LOKMA ANAHTAR	5,50	65
0701050024	ELTA ÇATAL ÇAKMA ANAHTAR 24 MM	48,05	185	1107060008	1/4" ALTI KÖŞE 08 MM LOKMA ANAHTAR	5,50	65
0701050042	ELTA ÇATAL ÇAKMA ANAHTAR 42 MM	139,65	185	1107060009	1/4" ALTI KÖŞE 09 MM LOKMA ANAHTAR	5,80	65
0701050095	ELTA ÇATAL ÇAKMA ANAHTAR 95 MM	1.008,60	185	1107060010	1/4" ALTI KÖŞE 10 MM LOKMA ANAHTAR	5,80	65
0741050010	MAKARALI UZATMA KABLOSU 10 M (3x1.5MM)	300,40	161	1107060011	1/4" ALTI KÖŞE 11 MM LOKMA ANAHTAR	7,40	65
0741050025	MAKARALI UZATMA KABLOSU 25 M (3x1.5MM)	585,75	161	1107060012	1/4" ALTI KÖŞE 12 MM LOKMA ANAHTAR	7,40	65
0741050050	MAKARALI UZATMA KABLOSU 50 M (3x1.5MM)	819,90	161	1107060013	1/4" ALTI KÖŞE 13 MM LOKMA ANAHTAR	8,20	65
0741550003	3 SIRALI TEL FIRÇA AĞAÇ SAPLI	12,65	161	1107060045	1/4" ALTI KÖŞE 4,5 MM LOKMA ANAHTAR	5,50	65
0741550004	4 SIRALI TEL FIRÇA AĞAÇ SAPLI	13,40	161	1107060055	1/4" ALTI KÖŞE 5,5 MM LOKMA ANAHTAR	5,50	65
0741550005	5 SIRALI TEL FIRÇA AĞAÇ SAPLI	14,95	161	1107061103	1/4" LOKMALI ALLEN UÇ 3 MM	9,00	66
0741550006	6 SIRALI TEL FIRÇA AĞAÇ SAPLI	16,00	161	1107061104	1/4" LOKMALI ALLEN UÇ 4 MM	9,00	66
0741650001	KIVRIK UÇLU FIRÇA PLASTİK SAPLI 270 MM	20,55	161	1107061105	1/4" LOKMALI ALLEN UÇ 5 MM	9,00	66
0750050024	YILDIZ ÇAKMA ANAHTAR 24 MM	95,60	56	1107061106	1/4" LOKMALI ALLEN UÇ 6 MM	9,00	66
0750050027	YILDIZ ÇAKMA ANAHTAR 27 MM	114,10	56	1107061107	1/4" LOKMALI ALLEN UÇ 7 MM	10,60	66
0750050030	YILDIZ ÇAKMA ANAHTAR 30 MM	136,20	56	1107061108	1/4" LOKMALI ALLEN UÇ 8 MM	10,60	66
0750050032	YILDIZ ÇAKMA ANAHTAR 32 MM	156,45	56	1107061110	1/4" LOKMALI ALLEN UÇ 10 MM	12,80	66
0750050036	YILDIZ ÇAKMA ANAHTAR 36 MM	177,05	56	1107061125	1/4" LOKMALI ALLEN UÇ 2,5 MM	9,00	66
0750050038	YILDIZ ÇAKMA ANAHTAR 38 MM	212,05	56	1107061208	1/4" LOKMALI STAR TORX UÇ T8	9,25	66
0750050041	YILDIZ ÇAKMA ANAHTAR 41 MM	231,50	56	1107061209	1/4" LOKMALI STAR TORX UÇ T9	9,25	66
0750050042	YILDIZ ÇAKMA ANAHTAR 42 MM	264,70	56	1107061210	1/4" LOKMALI STAR TORX UÇ T10	9,25	66
0750050046	YILDIZ ÇAKMA ANAHTAR 46 MM	276,80	56	1107061215	1/4" LOKMALI STAR TORX UÇ T15	9,25	66
0750050047	YILDIZ ÇAKMA ANAHTAR 47 MM	305,45	56	1107061220	1/4" LOKMALI STAR TORX UÇ T20	9,25	66
0750050050	YILDIZ ÇAKMA ANAHTAR 50 MM	326,85	56	1107061225	1/4" LOKMALI STAR TORX UÇ T25	9,25	66
0750050055	YILDIZ ÇAKMA ANAHTAR 55 MM	459,80	56	1107061227	1/4" LOKMALI STAR TORX UÇ T27	9,25	66
0750050060	YILDIZ ÇAKMA ANAHTAR 60 MM	498,90	56	1107061230	1/4" LOKMALI STAR TORX UÇ T30	9,25	66
0750050065	YILDIZ ÇAKMA ANAHTAR 65 MM	652,25	56	1107061240	1/4" LOKMALI STAR TORX UÇ T40	9,25	66
0750050070	YILDIZ ÇAKMA ANAHTAR 70 MM	746,65	56	1107061308	1/4" LOKMALI STAR DELIKLİ TORX UÇ TR8	10,80	66
0750050075	YILDIZ ÇAKMA ANAHTAR 75 MM	799,15	56	1107061309	1/4" LOKMALI STAR DELIKLİ TORX UÇ TR9	10,80	66
0750050080	YILDIZ ÇAKMA ANAHTAR 80 MM	1.135,20	56	1107061310	1/4" LOKMALI STAR DELIKLİ TORX UÇ TR10	10,80	66
0750050085	YILDIZ ÇAKMA ANAHTAR 85 MM	1.277,25	56	1107061315	1/4" LOKMALI STAR DELIKLİ TORX UÇ TR15	10,80	66
0750050090	YILDIZ ÇAKMA ANAHTAR 90 MM	1.571,10	56	1107061320	1/4" LOKMALI STAR DELIKLİ TORX UÇ TR20	10,80	66
0750050095	YILDIZ ÇAKMA ANAHTAR 95 MM	1.771,60	56	1107061325	1/4" LOKMALI STAR DELIKLİ TORX UÇ TR25	10,80	66
0750050100	YILDIZ ÇAKMA ANAHTAR 100 MM	2.048,05	56	1107061327	1/4" LOKMALI STAR DELIKLİ TORX UÇ TR27	10,80	66
0750050105	YILDIZ ÇAKMA ANAHTAR 105 MM	2.114,10	56	1107061330	1/4" LOKMALI STAR DELIKLİ TORX UÇ TR30	10,80	66
0750050110	YILDIZ ÇAKMA ANAHTAR 110 MM	2.260,00	56	1107061340	1/4" LOKMALI STAR DELIKLİ TORX UÇ TR40	12,65	66
0750050115	YILDIZ ÇAKMA ANAHTAR 115 MM	2.533,30	56	1107061403	1/4" LOKMALI DÜZ UÇ 3 MM	9,00	66
0750050120	YILDIZ ÇAKMA ANAHTAR 120 MM	3.481,75	56	1107061404	1/4" LOKMALI DÜZ UÇ 4 MM	9,00	66
0750050125	YILDIZ ÇAKMA ANAHTAR 125 MM	0,00	56	1107061407	1/4" LOKMALI DÜZ UÇ 7 MM	9,00	66
0750050130	YILDIZ ÇAKMA ANAHTAR 130 MM	0,00	56	1107061408	1/4" LOKMALI DÜZ UÇ 8 MM	10,90	66
0750050135	YILDIZ ÇAKMA ANAHTAR 135 MM	0,00	56	1107061410	1/4" LOKMALI DÜZ UÇ 10 MM	11,80	66
0750050140	YILDIZ ÇAKMA ANAHTAR 140 MM	0,00	56	1107061435	1/4" LOKMALI DÜZ UÇ 3,5 MM	9,00	66
0750050145	YILDIZ ÇAKMA ANAHTAR 145 MM	0,00	56	1107061445	1/4" LOKMALI DÜZ UÇ 4,5 MM	9,00	66
0750050150	YILDIZ ÇAKMA ANAHTAR 150 MM	0,00	56	1107061455	1/4" LOKMALI DÜZ UÇ 5,5 MM	9,00	66
0750050155	YILDIZ ÇAKMA ANAHTAR 155 MM	0,00	56	1107061465	1/4" LOKMALI DÜZ UÇ 6,5 MM	9,00	66
0750050160	YILDIZ ÇAKMA ANAHTAR 160 MM	0,00	56	1107061501	1/4" LOKMALI YILDIZ UÇ PH1	9,00	67
0750050165	YILDIZ ÇAKMA ANAHTAR 165 MM	0,00	56	1107061502	1/4" LOKMALI YILDIZ UÇ PH2	9,00	67
0750050170	YILDIZ ÇAKMA ANAHTAR 170 MM	0,00	56	1107061503	1/4" LOKMALI YILDIZ UÇ PH3	9,00	67
0750050180	YILDIZ ÇAKMA ANAHTAR 180 MM	0,00	56	1107061504	1/4" LOKMALI YILDIZ UÇ PH4	9,00	67
0751050042	ELTA YILDIZ ÇAKMA ANAHTAR 42 MM	145,10	185	1107064004	1/4" ALTI KÖŞE DERİN 4 MM LOKMA ANAHTAR	10,80	65
0751050070	ELTA YILDIZ ÇAKMA ANAHTAR 70 MM	409,40	185	1107064005	1/4" ALTI KÖŞE DERİN 5 MM LOKMA ANAHTAR	10,80	65
0751050085	ELTA YILDIZ ÇAKMA ANAHTAR 85 MM	700,25	185	1107064006	1/4" ALTI KÖŞE DERİN 6 MM LOKMA ANAHTAR	12,10	65
0860052528	KANCA ANAHTAR DÖRTGEN UÇLU 25/28	49,05	57	1107064007	1/4" ALTI KÖŞE DERİN 7 MM LOKMA ANAHTAR	12,10	65
0860053032	KANCA ANAHTAR DÖRTGEN UÇLU 30/32	49,05	57	1107064008	1/4" ALTI KÖŞE DERİN 8 MM LOKMA ANAHTAR	12,10	65
0860053436	KANCA ANAHTAR DÖRTGEN UÇLU 34/36	53,05	57	1107064009	1/4" ALTI KÖŞE DERİN 9 MM LOKMA ANAHTAR	12,10	65
0860054042	KANCA ANAHTAR DÖRTGEN UÇLU 40/42	53,05	57	1107064010	1/4" ALTI KÖŞE DERİN 10 MM LOKMA ANAHTAR	12,10	65
0860054550	KANCA ANAHTAR DÖRTGEN UÇLU 45/50	61,50	57	1107064011	1/4" ALTI KÖŞE DERİN 11 MM LOKMA ANAHTAR	13,00	65
0860055255	KANCA ANAHTAR DÖRTGEN UÇLU 52/55	61,50	57	1107064012	1/4" ALTI KÖŞE DERİN 12 MM LOKMA ANAHTAR	13,00	65
0860055862	KANCA ANAHTAR DÖRTGEN UÇLU 58/62	74,15	57	1107064013	1/4" ALTI KÖŞE DERİN 13 MM LOKMA ANAHTAR	13,00	65
0860055875	KANCA ANAHTAR DÖRTGEN UÇLU 68/75	74,15	57	1107064055	1/4" ALTI KÖŞE DERİN 5,5 MM LOKMA ANAHTAR	10,80	65
0860058090	KANCA ANAHTAR DÖRTGEN UÇLU 80/90	96,80	57	1107065010	1/4" BITS TUTUCU LOKMA MIKNATISLI	18,55	69
0860059510	KANCA ANAHTAR DÖRTGEN UÇLU 95/100	96,80	57	1108006010	1/2" ALTI KÖŞE DERİN LOKMA TAKIMI 10 PARÇA	464,20	74
1107001042	1/4" BITS UÇLU LOKMA TAKIMI 42 PARÇA	521,15	67	1108006010	1/2" ALTI KÖŞE DERİN 10 MM LOKMA ANAHTAR	43,15	74
1107006014	1/4" DERİN LOKMA ANAHTAR TAKIMI 14 PARÇA	256,90	65	1108006011	1/2" ALTI KÖŞE DERİN 11 MM LOKMA ANAHTAR	43,15	74
1107006015	1/4" ALTI KÖŞE LOKMA ANAHTAR TAKIMI 15 PARÇA	234,40	69	1108006012	1/2" ALTI KÖŞE DERİN 12 MM LOKMA ANAHTAR	43,15	74
1107060004	1/4" ALTI KÖŞE 04 MM LOKMA ANAHTAR	5,50	65	1108060013	1/2" ALTI KÖŞE DERİN 13 MM LOKMA ANAHTAR	46,25	74

KOD	ÜRÜN	FİYAT	SAYFA
1108060014	1/2" ALTI KÖŞE DERİN 14 MM LOKMA ANAHTAR	46,25	74
1108060015	1/2" ALTI KÖŞE DERİN 15 MM LOKMA ANAHTAR	46,25	74
1108060016	1/2" ALTI KÖŞE DERİN 16 MM LOKMA ANAHTAR	48,45	74
1108060017	1/2" ALTI KÖŞE DERİN 17 MM LOKMA ANAHTAR	48,45	74
1108060018	1/2" ALTI KÖŞE DERİN 18 MM LOKMA ANAHTAR	48,45	74
1108060019	1/2" ALTI KÖŞE DERİN 19 MM LOKMA ANAHTAR	50,65	74
1108067010	1/2" ALTI KÖŞE 10 MM HAVALI DERİN LOKMA ANAHTAR	44,20	84
1108067011	1/2" ALTI KÖŞE 11 MM HAVALI DERİN LOKMA ANAHTAR	44,20	84
1108067012	1/2" ALTI KÖŞE 12 MM HAVALI DERİN LOKMA ANAHTAR	44,20	84
1108067013	1/2" ALTI KÖŞE 13 MM HAVALI DERİN LOKMA ANAHTAR	48,00	84
1108067014	1/2" ALTI KÖŞE 14 MM HAVALI DERİN LOKMA ANAHTAR	48,00	84
1108067015	1/2" ALTI KÖŞE 15 MM HAVALI DERİN LOKMA ANAHTAR	53,60	84
1108067016	1/2" ALTI KÖŞE 16 MM HAVALI DERİN LOKMA ANAHTAR	53,60	84
1108067017	1/2" ALTI KÖŞE 17 MM HAVALI DERİN LOKMA ANAHTAR	53,60	84
1108067018	1/2" ALTI KÖŞE 18 MM HAVALI DERİN LOKMA ANAHTAR	53,60	84
1108067019	1/2" ALTI KÖŞE 19 MM HAVALI DERİN LOKMA ANAHTAR	53,60	84
1108067021	1/2" ALTI KÖŞE 21 MM HAVALI DERİN LOKMA ANAHTAR	55,90	84
1108067022	1/2" ALTI KÖŞE 22 MM HAVALI DERİN LOKMA ANAHTAR	55,90	84
1108067024	1/2" ALTI KÖŞE 24 MM HAVALI DERİN LOKMA ANAHTAR	59,10	84
1108067027	1/2" ALTI KÖŞE 27 MM HAVALI DERİN LOKMA ANAHTAR	78,20	84
1108067030	1/2" ALTI KÖŞE 30 MM HAVALI DERİN LOKMA ANAHTAR	87,60	84
1108067032	1/2" ALTI KÖŞE 32 MM HAVALI DERİN LOKMA ANAHTAR	93,40	84
1110060019	3/8" ALTI KÖŞE LOKMA TAKIMI 19 PARÇA	552,20	71
1110060006	3/8" ALTI KÖŞE 06 MM LOKMA ANAHTAR	14,35	70
1110060007	3/8" ALTI KÖŞE 07 MM LOKMA ANAHTAR	14,35	70
1110060008	3/8" ALTI KÖŞE 08 MM LOKMA ANAHTAR	14,35	70
1110060009	3/8" ALTI KÖŞE 09 MM LOKMA ANAHTAR	14,35	70
1110060010	3/8" ALTI KÖŞE 10 MM LOKMA ANAHTAR	14,35	70
1110060011	3/8" ALTI KÖŞE 11 MM LOKMA ANAHTAR	14,35	70
1110060012	3/8" ALTI KÖŞE 12 MM LOKMA ANAHTAR	14,35	70
1110060013	3/8" ALTI KÖŞE 13 MM LOKMA ANAHTAR	15,35	70
1110060014	3/8" ALTI KÖŞE 14 MM LOKMA ANAHTAR	15,35	70
1110060015	3/8" ALTI KÖŞE 15 MM LOKMA ANAHTAR	15,35	70
1110060016	3/8" ALTI KÖŞE 16 MM LOKMA ANAHTAR	16,05	70
1110060017	3/8" ALTI KÖŞE 17 MM LOKMA ANAHTAR	16,05	70
1110060018	3/8" ALTI KÖŞE 18 MM LOKMA ANAHTAR	16,05	70
1110060019	3/8" ALTI KÖŞE 19 MM LOKMA ANAHTAR	18,50	70
1110060021	3/8" ALTI KÖŞE 21 MM LOKMA ANAHTAR	20,15	70
1110060022	3/8" ALTI KÖŞE 22 MM LOKMA ANAHTAR	21,55	70
1110060023	3/8" ALTI KÖŞE 23 MM LOKMA ANAHTAR	21,55	70
1110069208	3/8" BUJİ LOKMA LASTİKLİ 21 MM	28,05	70
1113001038	1/4" - 1/2" ALTI KÖŞE LOKMA ANAHTAR TAKIMI 35 PARÇA	926,05	78
1113001107	1/2" LOKMALI ALLEN UÇ TAKIMI (60MM - 7 PARÇA)	208,20	75
1113002017	1/2" ALTI KÖŞE LOKMA ANAHTAR TAKIMI 17 PARÇA	646,20	79
1113002024	1/2" ALTI KÖŞE LOKMA ANAHTAR TAKIMI 24 PARÇA	839,20	79
1113003020	1/2" MANYETİK LOKMALI UÇ TAKIMI 20 PARÇA	313,15	80
1113006007	1/2" STAR (TORX) LOKMA ANAHTAR TAKIMI 7 PARÇA	178,20	74
1113006009	1/2" LOKMALI TORX UÇ TAKIMI (60MM - 9 PARÇA)	311,40	75
1113006017	1/2" LOKMALI ALLEN UÇ VE STAR (TORX) UÇ TAKIMI 17 PARÇA	613,30	76
1113006145	1/2" LOKMA ANAHTAR SEHPASI (DOLU - 145)	3.853,00	72
1113009003	1/2" ALAŞIMLI JANT LOKMA TAKIMI 3 PARÇA	342,60	83
1113009007	1/2" ALAŞIMLI JANT LOKMA TAKIMI 7 PARÇA	562,15	83
1113060210	1/2" STAR (TORX) LOKMA ANAHTAR E-10	22,10	74
1113060212	1/2" STAR (TORX) LOKMA ANAHTAR E-12	22,10	74
1113060214	1/2" STAR (TORX) LOKMA ANAHTAR E-14	22,10	74
1113060216	1/2" STAR (TORX) LOKMA ANAHTAR E-16	22,10	74
1113060218	1/2" STAR (TORX) LOKMA ANAHTAR E-18	22,10	74
1113060220	1/2" STAR (TORX) LOKMA ANAHTAR E-20	24,85	74
1113061008	1/2" ALTI KÖŞE 8 MM LOKMA ANAHTAR	16,60	72
1113061009	1/2" ALTI KÖŞE 9 MM LOKMA ANAHTAR	16,60	72
1113061010	1/2" ALTI KÖŞE 10 MM LOKMA ANAHTAR	20,60	72
1113061011	1/2" ALTI KÖŞE 11 MM LOKMA ANAHTAR	20,60	72
1113061012	1/2" ALTI KÖŞE 12 MM LOKMA ANAHTAR	20,60	72
1113061013	1/2" ALTI KÖŞE 13 MM LOKMA ANAHTAR	22,15	72
1113061014	1/2" ALTI KÖŞE 14 MM LOKMA ANAHTAR	22,15	72
1113061015	1/2" ALTI KÖŞE 15 MM LOKMA ANAHTAR	22,15	72
1113061016	1/2" ALTI KÖŞE 16 MM LOKMA ANAHTAR	23,20	72

KOD	ÜRÜN	FİYAT	SAYFA
1113061017	1/2" ALTI KÖŞE 17 MM LOKMA ANAHTAR	23,20	72
1113061018	1/2" ALTI KÖŞE 18 MM LOKMA ANAHTAR	23,20	72
1113061019	1/2" ALTI KÖŞE 19 MM LOKMA ANAHTAR	24,25	72
1113061020	1/2" ALTI KÖŞE 20 MM LOKMA ANAHTAR	24,25	72
1113061021	1/2" ALTI KÖŞE 21 MM LOKMA ANAHTAR	24,25	72
1113061022	1/2" ALTI KÖŞE 22 MM LOKMA ANAHTAR	24,25	72
1113061023	1/2" ALTI KÖŞE 23 MM LOKMA ANAHTAR	25,25	72
1113061024	1/2" ALTI KÖŞE 24 MM LOKMA ANAHTAR	25,25	72
1113061025	1/2" ALTI KÖŞE 25 MM LOKMA ANAHTAR	25,25	72
1113061026	1/2" ALTI KÖŞE 26 MM LOKMA ANAHTAR	25,25	72
1113061027	1/2" ALTI KÖŞE 27 MM LOKMA ANAHTAR	29,00	72
1113061028	1/2" ALTI KÖŞE 28 MM LOKMA ANAHTAR	29,00	72
1113061029	1/2" ALTI KÖŞE 29 MM LOKMA ANAHTAR	30,50	72
1113061030	1/2" ALTI KÖŞE 30 MM LOKMA ANAHTAR	30,50	72
1113061032	1/2" ALTI KÖŞE 32 MM LOKMA ANAHTAR	31,75	72
1113061105	1/2" LOKMALI ALLEN UÇ 5 MM	28,05	75
1113061106	1/2" LOKMALI ALLEN UÇ 6 MM	28,05	75
1113061107	1/2" LOKMALI ALLEN UÇ 7 MM	28,05	75
1113061108	1/2" LOKMALI ALLEN UÇ 8 MM	28,05	75
1113061110	1/2" LOKMALI ALLEN UÇ 10 MM	32,00	75
1113061112	1/2" LOKMALI ALLEN UÇ 12 MM	32,00	75
1113061114	1/2" LOKMALI ALLEN UÇ 14 MM	32,00	75
1113061220	1/2" T 20 LOKMALI STAR (TORX) UÇ	34,60	75
1113061225	1/2" LOKMALI STAR (TORX) UÇ T 25	34,60	75
1113061227	1/2" LOKMALI STAR (TORX) UÇ T 27	34,60	75
1113061230	1/2" LOKMALI STAR (TORX) UÇ T 30	34,60	75
1113061240	1/2" LOKMALI STAR (TORX) UÇ T 40	34,60	75
1113061245	1/2" LOKMALI STAR (TORX) UÇ T 45	34,60	75
1113061250	1/2" LOKMALI STAR (TORX) UÇ T 50	34,60	75
1113061255	1/2" LOKMALI STAR (TORX) UÇ T 55	34,60	75
1113061260	1/2" LOKMALI STAR (TORX) UÇ T 60	34,60	75
1113063008	1/2" 08 MM MANYETİK LOKMA	18,90	80
1113063010	1/2" 10 MM MANYETİK LOKMA	27,45	80
1113063012	1/2" 12 MM MANYETİK LOKMA	27,45	80
1113063014	1/2" 14 MM MANYETİK LOKMA	33,50	80
1113063120	1/2" T 20 MANYETİK LOKMA TORX UÇ	11,65	80
1113063125	1/2" T 25 MANYETİK LOKMA TORX UÇ	11,65	80
1113063127	1/2" T 27 MANYETİK LOKMA TORX UÇ	11,65	80
1113063130	1/2" T 30 MANYETİK LOKMA TORX UÇ	11,65	80
1113063140	1/2" T 40 MANYETİK LOKMA TORX UÇ	11,65	80
1113063145	1/2" T 45 MANYETİK LOKMA TORX UÇ	14,20	80
1113063150	1/2" T 50 MANYETİK LOKMA TORX UÇ	15,05	80
1113063155	1/2" T 55 MANYETİK LOKMA TORX UÇ	16,25	80
1113063160	1/2" T 60 MANYETİK LOKMA TORX UÇ	17,55	80
1113063205	1/2" 5 MM MANYETİK LOKMA ALLEN UÇ	10,20	80
1113063206	1/2" 6 MM MANYETİK LOKMA ALLEN UÇ	10,20	80
1113063207	1/2" 7 MM MANYETİK LOKMA ALLEN UÇ	10,20	80
1113063208	1/2" 8 MM MANYETİK LOKMA ALLEN UÇ	11,20	80
1113063210	1/2" 10 MM MANYETİK LOKMA ALLEN UÇ	11,50	80
1113063212	1/2" 12 MM MANYETİK LOKMA ALLEN UÇ	14,75	80
1113063214	1/2" 14 MM MANYETİK LOKMA ALLEN UÇ	16,50	80
1113064105	1/2" LOKMALI ALLEN UÇ 5 MM (100 MM)	31,90	75
1113064106	1/2" LOKMALI ALLEN UÇ 6 MM (100 MM)	31,90	75
1113064107	1/2" LOKMALI ALLEN UÇ 7 MM (100 MM)	31,90	75
1113064108	1/2" LOKMALI ALLEN UÇ 8 MM (100 MM)	31,90	75
1113064110	1/2" LOKMALI ALLEN UÇ 10 MM (100 MM)	36,90	75
1113064112	1/2" LOKMALI ALLEN UÇ 12 MM (100 MM)	36,90	75
1113064114	1/2" LOKMALI ALLEN UÇ 14 MM (100 MM)	44,50	75
1113064117	1/2" LOKMALI ALLEN UÇ 17 MM (100 MM)	59,45	75
1113064220	1/2" LOKMALI STAR (TORX) UÇ T 20 (100 MM)	37,65	75
1113064225	1/2" LOKMALI STAR (TORX) UÇ T 25 (100 MM)	37,65	75
1113064227	1/2" LOKMALI STAR (TORX) UÇ T 27 (100 MM)	37,65	75
1113064230	1/2" LOKMALI STAR (TORX) UÇ T 30 (100 MM)	37,65	75
1113064240	1/2" LOKMALI STAR (TORX) UÇ T 40 (100 MM)	37,65	75
1113064245	1/2" LOKMALI STAR (TORX) UÇ T 45 (100 MM)	37,65	75
1113064250	1/2" LOKMALI STAR (TORX) UÇ T 50 (100 MM)	37,65	75
1113064255	1/2" LOKMALI STAR (TORX) UÇ T 55 (100 MM)	37,65	75

KOD	ÜRÜN	FİYAT	SAYFA	KOD	ÜRÜN	FİYAT	SAYFA
1113064260	1/2" LOKMALI STAR (TORX) UÇ T 60 (100 MM)	37,65	75	1114065016	M 16 1/2 LOKMALI (RİBE) BİTS UÇ	66,75	76
1113065010	1/2" BİTS TUTUCU LOKMA	22,85	77	1115002017	ELTA 1/2" ALTI KÖŞE LOKMA ANAHTAR TAKIMI 17 PARÇA	543,75	187
1113067010	1/2" ALTI KÖŞE 10 MM HAVALI LOKMA ANAHTAR	24,95	84	1115002024	ELTA 1/2" ALTI KÖŞE LOKMA ANAHTAR TAKIMI 24 PARÇA	706,35	187
1113067011	1/2" ALTI KÖŞE 11 MM HAVALI LOKMA ANAHTAR	24,95	84	1115006018	ELTA 1/2" ALTI KÖŞE LOKMA ANAHTAR TAKIMI 18 PARÇA	663,05	187
1113067012	1/2" ALTI KÖŞE 12 MM HAVALI LOKMA ANAHTAR	24,95	84	1115060010	ELTA 1/2" ALTI KÖŞE 10 MM LOKMA ANAHTAR	16,80	186
1113067013	1/2" ALTI KÖŞE 13 MM HAVALI LOKMA ANAHTAR	26,70	84	1115060011	ELTA 1/2" ALTI KÖŞE 11 MM LOKMA ANAHTAR	16,80	186
1113067014	1/2" ALTI KÖŞE 14 MM HAVALI LOKMA ANAHTAR	26,70	84	1115060012	ELTA 1/2" ALTI KÖŞE 12 MM LOKMA ANAHTAR	16,80	186
1113067015	1/2" ALTI KÖŞE 15 MM HAVALI LOKMA ANAHTAR	26,70	84	1115060013	ELTA 1/2" ALTI KÖŞE 13 MM LOKMA ANAHTAR	17,40	186
1113067016	1/2" ALTI KÖŞE 16 MM HAVALI LOKMA ANAHTAR	27,95	84	1115060014	ELTA 1/2" ALTI KÖŞE 14 MM LOKMA ANAHTAR	17,40	186
1113067017	1/2" ALTI KÖŞE 17 MM HAVALI LOKMA ANAHTAR	28,00	84	1115060015	ELTA 1/2" ALTI KÖŞE 15 MM LOKMA ANAHTAR	17,40	186
1113067018	1/2" ALTI KÖŞE 18 MM HAVALI LOKMA ANAHTAR	28,05	84	1115060016	ELTA 1/2" ALTI KÖŞE 16 MM LOKMA ANAHTAR	18,15	186
1113067019	1/2" ALTI KÖŞE 19 MM HAVALI LOKMA ANAHTAR	28,65	84	1115060017	ELTA 1/2" ALTI KÖŞE 17 MM LOKMA ANAHTAR	18,15	186
1113067021	1/2" ALTI KÖŞE 21 MM HAVALI LOKMA ANAHTAR	29,15	84	1115060018	ELTA 1/2" ALTI KÖŞE 18 MM LOKMA ANAHTAR	18,15	186
1113067022	1/2" ALTI KÖŞE 22 MM HAVALI LOKMA ANAHTAR	29,15	84	1115060019	ELTA 1/2" ALTI KÖŞE 19 MM LOKMA ANAHTAR	19,50	186
1113067024	1/2" ALTI KÖŞE 24 MM HAVALI LOKMA ANAHTAR	33,45	84	1115060020	ELTA 1/2" ALTI KÖŞE 20 MM LOKMA ANAHTAR	19,50	186
1113067027	1/2" ALTI KÖŞE 27 MM HAVALI LOKMA ANAHTAR	48,65	84	1115060021	ELTA 1/2" ALTI KÖŞE 21 MM LOKMA ANAHTAR	19,50	186
1113069160	1/2" BUJİ LOKMA ANAHTAR 16 MM LASTİKLİ	32,65	73	1115060022	ELTA 1/2" ALTI KÖŞE 22 MM LOKMA ANAHTAR	19,50	186
1113069208	1/2" BUJİ LOKMA ANAHTAR 21 MM LASTİKLİ	39,10	73	1115060023	ELTA 1/2" ALTI KÖŞE 23 MM LOKMA ANAHTAR	21,20	186
1113316100	1/2" LOKMA ANAHTAR SEHPASI (BOŞ)	409,50	206	1115060024	ELTA 1/2" ALTI KÖŞE 24 MM LOKMA ANAHTAR	21,20	186
1114006024	1/2" ONİKİ KÖŞE LOKMA ANAHTAR TAKIMI 24 PARÇA	903,55	79	1115060026	ELTA 1/2" ALTI KÖŞE 26 MM LOKMA ANAHTAR	23,80	186
1114061010	1/2" ONİKİ KÖŞE 10 MM LOKMA ANAHTAR	23,05	73	1115060027	ELTA 1/2" ALTI KÖŞE 27 MM LOKMA ANAHTAR	27,10	186
1114061011	1/2" ONİKİ KÖŞE 11 MM LOKMA ANAHTAR	23,05	73	1115060028	ELTA 1/2" ALTI KÖŞE 28 MM LOKMA ANAHTAR	28,55	186
1114061012	1/2" ONİKİ KÖŞE 12 MM LOKMA ANAHTAR	23,05	73	1115060030	ELTA 1/2" ALTI KÖŞE 30 MM LOKMA ANAHTAR	28,55	186
1114061013	1/2" ONİKİ KÖŞE 13 MM LOKMA ANAHTAR	24,95	73	1115060032	ELTA 1/2" ALTI KÖŞE 32 MM LOKMA ANAHTAR	30,50	186
1114061014	1/2" ONİKİ KÖŞE 14 MM LOKMA ANAHTAR	24,95	73	1115067010	ELTA 1/2" ALTI KÖŞE HAVALI 10 MM LOKMA ANAHTAR	14,05	188
1114061015	1/2" ONİKİ KÖŞE 15 MM LOKMA ANAHTAR	24,95	73	1115067011	ELTA 1/2" ALTI KÖŞE HAVALI 11 MM LOKMA ANAHTAR	14,05	188
1114061016	1/2" ONİKİ KÖŞE 16 MM LOKMA ANAHTAR	26,00	73	1115067012	ELTA 1/2" ALTI KÖŞE HAVALI 12 MM LOKMA ANAHTAR	14,05	188
1114061017	1/2" ONİKİ KÖŞE 17 MM LOKMA ANAHTAR	26,00	73	1115067013	ELTA 1/2" ALTI KÖŞE HAVALI 13 MM LOKMA ANAHTAR	14,05	188
1114061018	1/2" ONİKİ KÖŞE 18 MM LOKMA ANAHTAR	26,00	73	1115067014	ELTA 1/2" ALTI KÖŞE HAVALI 14 MM LOKMA ANAHTAR	14,05	188
1114061019	1/2" ONİKİ KÖŞE 19 MM LOKMA ANAHTAR	27,25	73	1115067015	ELTA 1/2" ALTI KÖŞE HAVALI 15 MM LOKMA ANAHTAR	15,95	188
1114061020	1/2" ONİKİ KÖŞE 20 MM LOKMA ANAHTAR	27,25	73	1115067016	ELTA 1/2" ALTI KÖŞE HAVALI 16 MM LOKMA ANAHTAR	15,95	188
1114061021	1/2" ONİKİ KÖŞE 21 MM LOKMA ANAHTAR	27,25	73	1115067017	ELTA 1/2" ALTI KÖŞE HAVALI 17 MM LOKMA ANAHTAR	18,40	188
1114061022	1/2" ONİKİ KÖŞE 22 MM LOKMA ANAHTAR	27,25	73	1115067018	ELTA 1/2" ALTI KÖŞE HAVALI 18 MM LOKMA ANAHTAR	18,40	188
1114061023	1/2" ONİKİ KÖŞE 23 MM LOKMA ANAHTAR	28,40	73	1115067019	ELTA 1/2" ALTI KÖŞE HAVALI 19 MM LOKMA ANAHTAR	18,40	188
1114061024	1/2" ONİKİ KÖŞE 24 MM LOKMA ANAHTAR	28,40	73	1115067021	ELTA 1/2" ALTI KÖŞE HAVALI 21 MM LOKMA ANAHTAR	21,05	188
1114061026	1/2" ONİKİ KÖŞE 26 MM LOKMA ANAHTAR	29,65	73	1115067022	ELTA 1/2" ALTI KÖŞE HAVALI 22 MM LOKMA ANAHTAR	21,05	188
1114061027	1/2" ONİKİ KÖŞE 27 MM LOKMA ANAHTAR	33,90	73	1115067024	ELTA 1/2" ALTI KÖŞE HAVALI 24 MM LOKMA ANAHTAR	24,55	188
1114061028	1/2" ONİKİ KÖŞE 28 MM LOKMA ANAHTAR	33,90	73	1115067027	ELTA 1/2" ALTI KÖŞE HAVALI 27 MM LOKMA ANAHTAR	28,35	188
1114061030	1/2" ONİKİ KÖŞE 30 MM LOKMA ANAHTAR	35,60	73	1119006114	3/4" ALTI KÖŞE LOKMA ANAHTAR TAKIMI 14 PARÇA	2.027,35	82
1114061032	1/2" ONİKİ KÖŞE 32 MM LOKMA ANAHTAR	37,35	73	1119061022	3/4" ALTI KÖŞE 22 MM LOKMA ANAHTAR	53,30	81
1114064005	1/2" ON İKİ KÖŞE M 5 LOKMALI BİTS UÇ YİVLİ (60 MM)	25,45	76	1119061024	3/4" ALTI KÖŞE 24 MM LOKMA ANAHTAR	53,30	81
1114064006	1/2" ON İKİ KÖŞE M 6 LOKMALI BİTS UÇ YİVLİ (60 MM)	25,45	76	1119061027	3/4" ALTI KÖŞE 27 MM LOKMA ANAHTAR	55,05	81
1114064008	1/2" ON İKİ KÖŞE M 8 LOKMALI BİTS UÇ YİVLİ (60 MM)	25,45	76	1119061030	3/4" ALTI KÖŞE 30 MM LOKMA ANAHTAR	59,35	81
1114064010	1/2" ON İKİ KÖŞE M 10 LOKMALI BİTS UÇ YİVLİ (60 MM)	25,45	76	1119061032	3/4" ALTI KÖŞE 32 MM LOKMA ANAHTAR	61,75	81
1114064012	1/2" ON İKİ KÖŞE M 12 LOKMALI BİTS UÇ YİVLİ (60 MM)	30,15	76	1119061034	3/4" ALTI KÖŞE 34 MM LOKMA ANAHTAR	81,45	81
1114064106	1/2" ON İKİ KÖŞE M 6 LOKMALI BİTS UÇ YİVLİ (80 MM)	32,10	76	1119061036	3/4" ALTI KÖŞE 36 MM LOKMA ANAHTAR	81,45	81
1114064108	1/2" ON İKİ KÖŞE M 8 LOKMALI BİTS UÇ YİVLİ (80 MM)	32,10	76	1119061038	3/4" ALTI KÖŞE 38 MM LOKMA ANAHTAR	81,45	81
1114064110	1/2" ON İKİ KÖŞE M 10 LOKMALI BİTS UÇ YİVLİ (80 MM)	35,35	76	1119061041	3/4" ALTI KÖŞE 41 MM LOKMA ANAHTAR	119,75	81
1114064112	1/2" ON İKİ KÖŞE M 12 LOKMALI BİTS UÇ YİVLİ (80 MM)	36,55	76	1119061046	3/4" ALTI KÖŞE 46 MM LOKMA ANAHTAR	127,50	81
1114064114	1/2" ON İKİ KÖŞE M 14 LOKMALI BİTS UÇ YİVLİ (80 MM)	39,15	76	1119061050	3/4" ALTI KÖŞE 50 MM LOKMA ANAHTAR	153,10	81
1114064208	1/2" ON İKİ KÖŞE M 8 LOKMALI BİTS UÇ YİVLİ (140 MM)	36,00	76	1119061055	3/4" ALTI KÖŞE 55 MM LOKMA ANAHTAR	194,95	81
1114064210	1/2" ON İKİ KÖŞE M 10 LOKMALI BİTS UÇ YİVLİ (140 MM)	44,15	76	1119061060	3/4" ALTI KÖŞE 60 MM LOKMA ANAHTAR	232,80	81
1114064212	1/2" ON İKİ KÖŞE M 12 LOKMALI BİTS UÇ YİVLİ (140 MM)	49,75	76	1119067019	3/4" ALTI KÖŞE 19 MM HAVALI LOKMA ANAHTAR	78,20	85
1114064214	1/2" ON İKİ KÖŞE M 14 LOKMALI BİTS UÇ YİVLİ (140MM)	55,85	76	1119067021	3/4" ALTI KÖŞE 21 MM HAVALI LOKMA ANAHTAR	78,20	85
1114064216	1/2" ON İKİ KÖŞE M 16 LOKMALI BİTS UÇ YİVLİ (140 MM)	81,00	76	1119067022	3/4" ALTI KÖŞE 22 MM HAVALI LOKMA ANAHTAR	78,20	85
1114065004	M 4 1/2 LOKMALI (RİBE) BİTS UÇ	35,00	76	1119067024	3/4" ALTI KÖŞE 24 MM HAVALI LOKMA ANAHTAR	78,20	85
1114065005	M 5 1/2 LOKMALI (RİBE) BİTS UÇ	35,00	76	1119067027	3/4" ALTI KÖŞE 27 MM HAVALI LOKMA ANAHTAR	80,40	85
1114065006	M 6 1/2 LOKMALI (RİBE) BİTS UÇ	35,00	76	1119067030	3/4" ALTI KÖŞE 30 MM HAVALI LOKMA ANAHTAR	86,65	85
1114065007	M 7 1/2 LOKMALI (RİBE) BİTS UÇ	35,00	76	1119067032	3/4" ALTI KÖŞE 32 MM HAVALI LOKMA ANAHTAR	86,65	85
1114065008	M 8 1/2 LOKMALI (RİBE) BİTS UÇ	35,00	76	1119067034	3/4" ALTI KÖŞE 34 MM HAVALI LOKMA ANAHTAR	113,00	85
1114065009	M 9 1/2 LOKMALI (RİBE) BİTS UÇ	35,30	76	1119067036	3/4" ALTI KÖŞE 36 MM HAVALI LOKMA ANAHTAR	113,00	85
1114065010	M 10 1/2 LOKMALI (RİBE) BİTS UÇ	35,30	76	1119067041	3/4" ALTI KÖŞE 41 MM HAVALI LOKMA ANAHTAR	174,35	85
1114065011	M 10,5 1/2 LOKMALI (RİBE) BİTS UÇ	36,10	76	1119067046	3/4" ALTI KÖŞE 46 MM HAVALI LOKMA ANAHTAR	185,35	85
1114065012	M 12 1/2 LOKMALI (RİBE) BİTS UÇ	44,95	76	1120006014	3/4" ON İKİ KÖŞE LOKMA ANAHTAR TAKIMI 14 PARÇA	2.076,75	82
1114065013	M 13 1/2 LOKMALI (RİBE) BİTS UÇ	49,35	76	1120061022	3/4" ONİKİ KÖŞE 22 MM LOKMA ANAHTAR	56,35	81
1114065014	M 14 1/2 LOKMALI (RİBE) BİTS UÇ	49,35	76	1120061024	3/4" ONİKİ KÖŞE 24 MM LOKMA ANAHTAR	56,35	81
				1120061027	3/4" ONİKİ KÖŞE 27 MM LOKMA ANAHTAR	58,10	81

KOD	ÜRÜN	FİYAT	SAYFA	KOD	ÜRÜN	FİYAT	SAYFA
1120061030	3/4" ONİKİ KÖŞE 30 MM LOKMA ANAHTAR	62,60	81	1419061022	3/4" ONİKİ KÖŞE 7/8" SAE LOKMA ANAHTAR	63,65	81
1120061032	3/4" ONİKİ KÖŞE 32 MM LOKMA ANAHTAR	65,50	81	1419061024	3/4" ONİKİ KÖŞE 15/16" SAE LOKMA ANAHTAR	63,65	81
1120061034	3/4" ONİKİ KÖŞE 34 MM LOKMA ANAHTAR	86,15	81	1419061025	3/4" ONİKİ KÖŞE 1" SAE LOKMA ANAHTAR	63,90	81
1120061036	3/4" ONİKİ KÖŞE 36 MM LOKMA ANAHTAR	86,15	81	1419061027	3/4" ONİKİ KÖŞE 1 1/16" SAE LOKMA ANAHTAR	65,55	81
1120061041	3/4" ONİKİ KÖŞE 41 MM LOKMA ANAHTAR	127,15	81	1419061028	3/4" ONİKİ KÖŞE 1 1/8" SAE LOKMA ANAHTAR	65,55	81
1120061046	3/4" ONİKİ KÖŞE 46 MM LOKMA ANAHTAR	135,20	81	1419061032	3/4" ONİKİ KÖŞE 1 1/4" SAE LOKMA ANAHTAR	73,60	81
1120061050	3/4" ONİKİ KÖŞE 50 MM LOKMA ANAHTAR	161,85	81	1419061033	3/4" ONİKİ KÖŞE 1 5/16" SAE LOKMA ANAHTAR	91,60	81
1121060022	ELTA 3/4" ALTI KÖŞE 22 MM LOKMA ANAHTAR	31,45	188	1419061035	3/4" ONİKİ KÖŞE 1 3/8" SAE LOKMA ANAHTAR	91,60	81
1121060024	ELTA 3/4" ALTI KÖŞE 24 MM LOKMA ANAHTAR	31,45	188	1419061036	3/4" ONİKİ KÖŞE 1 7/16" SAE LOKMA ANAHTAR	95,95	81
1121060027	ELTA 3/4" ALTI KÖŞE 27 MM LOKMA ANAHTAR	32,10	188	1419061038	3/4" ONİKİ KÖŞE 1 1/2" SAE LOKMA ANAHTAR	95,95	81
1121060030	ELTA 3/4" ALTI KÖŞE 30 MM LOKMA ANAHTAR	35,65	188	1419061041	3/4" ONİKİ KÖŞE 1 5/8" SAE LOKMA ANAHTAR	142,20	81
1121060034	ELTA 3/4" ALTI KÖŞE 34 MM LOKMA ANAHTAR	53,75	188	1419061044	3/4" ONİKİ KÖŞE 1 3/4" SAE LOKMA ANAHTAR	150,10	81
1121060041	ELTA 3/4" ALTI KÖŞE 41 MM LOKMA ANAHTAR	76,65	188	1419061046	3/4" ONİKİ KÖŞE 1 13/16" SAE LOKMA ANAHTAR	151,05	81
1121060046	ELTA 3/4" ALTI KÖŞE 46 MM LOKMA ANAHTAR	82,80	188	1419061047	3/4" ONİKİ KÖŞE 1 7/8" SAE LOKMA ANAHTAR	181,20	81
1121060050	ELTA 3/4" ALTI KÖŞE 50 MM LOKMA ANAHTAR	100,75	188	1419061050	3/4" ONİKİ KÖŞE 2" SAE LOKMA ANAHTAR	182,50	81
1121060055	ELTA 3/4" ALTI KÖŞE 55 MM LOKMA ANAHTAR	120,00	188	1507060004	1/4"FX3/8" M LOKMA ADAPTÖRÜ	16,25	69
1121060060	ELTA 3/4" ALTI KÖŞE 60 MM LOKMA ANAHTAR	139,35	188	1507060038	1/4" MAFSAL 38 MM	24,75	67
1121067019	ELTA 3/4" ALTI KÖŞE HAVALI 19 MM LOKMA ANAHTAR	42,50	189	1507060050	1/4" ARA KOL 50 MM	13,50	67
1121067022	ELTA 3/4" ALTI KÖŞE HAVALI 22 MM LOKMA ANAHTAR	42,50	189	1507060100	1/4" ARA KOL 100 MM	14,65	67
1121067024	ELTA 3/4" ALTI KÖŞE HAVALI 24 MM LOKMA ANAHTAR	42,50	189	1507062110	1/4" LOKMA/BİTS TUTUCULU CİRCİR KOLU 72 DİŞ (110 MM)	187,20	68
1121067027	ELTA 3/4" ALTI KÖŞE HAVALI 27 MM LOKMA ANAHTAR	43,90	189	1507062140	1/4" CİRCİR KOLU PLASTİK SAPLI 140MM	96,85	68
1121067030	ELTA 3/4" ALTI KÖŞE HAVALI 30 MM LOKMA ANAHTAR	45,65	189	1507062150	1/4" MAFSALLI CİRCİR KOLU 72 DİŞ (150 MM)	298,35	68
1121067034	ELTA 3/4" ALTI KÖŞE HAVALI 34 MM LOKMA ANAHTAR	47,10	189	1507063150	1/4" ARA KOL FLEXİBLE 150 MM	55,50	67
1121067041	ELTA 3/4" ALTI KÖŞE HAVALI 41 MM LOKMA ANAHTAR	81,65	189	1507064080	1/4" DERİN LOKMA TORNAVİDA ADAPTÖRÜ	26,65	69
1121067046	ELTA 3/4" ALTI KÖŞE HAVALI 46 MM LOKMA ANAHTAR	81,65	189	1507064115	1/4" T KOL 115 MM	22,55	67
1125067024	1" ALTI KÖŞE 24 MM HAVALI LOKMA	140,80	86	1507066140	1" MANDALLI CİRCİR KOLU	128,70	68
1125067027	1" ALTI KÖŞE 27 MM HAVALI LOKMA	142,05	86	1507067115	1/4" MAFSALLI T KOL CİRCİR (72 DİŞ)	286,65	68
1125067030	1" ALTI KÖŞE 30 MM HAVALI LOKMA	143,25	86	1510060007	3/8"FX1/2" M LOKMA ADAPTÖRÜ 3/8"	27,70	71
1125067032	1" ALTI KÖŞE 32 MM HAVALI LOKMA	144,95	86	1510060056	3/8" MAFSAL 56,5 MM	40,40	70
1125067033	1" ALTI KÖŞE 33 MM HAVALI LOKMA	144,95	86	1510060075	3/8" ARA KOL 75 MM	24,85	70
1125067034	1" ALTI KÖŞE 34 MM HAVALI LOKMA	145,70	86	1510060150	3/8" ARA KOL 150 MM	37,65	70
1125067036	1" ALTI KÖŞE 36 MM HAVALI LOKMA	146,40	86	1510060200	3/8" CİRCİR KOLU 200 MM	155,75	70
1125067038	1" ALTI KÖŞE 38 MM HAVALI LOKMA	152,40	86	1510060215	3/8" MAFSALLI KOL 215 MM	86,30	71
1125067041	1" ALTI KÖŞE 41 MM HAVALI LOKMA	185,75	86	1510061200	3/8" T KOL 200 MM	58,10	71
1125067046	1" ALTI KÖŞE 46 MM HAVALI LOKMA	204,95	86	1513060002	1/2"Fx3/8" M LOKMA ADAPTÖRÜ	21,50	77
1125067050	1" ALTI KÖŞE 50 MM HAVALI LOKMA	218,60	86	1513060003	1/2"Fx3/4" M LOKMA ADAPTÖRÜ	33,80	77
1125067055	1" ALTI KÖŞE 55 MM HAVALI LOKMA	289,85	86	1513060032	1/2" CİRCİR KOLU 250 MM (32 DİŞ)	161,00	77
1125067060	1" ALTI KÖŞE 60 MM HAVALI LOKMA	362,25	86	1513060072	* 250 MM MAX GEAR CİRCİR KOLU (RATCHET HANDLE) (72 DİŞ) 1/2"	285,15	77
1207068008	1/4" SEKİZ KÖŞE 08 MM LOKMA ANAHTAR	7,65	65	1513062250	1/2" T KOL 250 MM	93,70	77
1207068010	1/4" SEKİZ KÖŞE 10 MM LOKMA ANAHTAR	9,00	65	1513064070	1/2" MAFSAL 70 MM	63,50	77
1225060036	1" ONİKİ KÖŞE 36 MM LOKMA	166,95	83	1513064075	1/2" ARA KOL 75 MM	38,30	77
1225060041	1" ONİKİ KÖŞE 41 MM LOKMA	181,75	83	1513064125	1/2" ARA KOL 125 MM	42,85	77
1225060046	1" ONİKİ KÖŞE 46 MM LOKMA	220,35	83	1513064250	1/2" ARA KOL 250 MM	65,25	77
1225060050	1" ONİKİ KÖŞE 50 MM LOKMA	261,00	83	1513065250	1/2" T KOL ADAPTÖR	40,00	77
1225060055	1" ONİKİ KÖŞE 55 MM LOKMA	335,40	83	1513067002	1/2"Fx3/8" M HAVALI LOKMA ADAPTÖRÜ	62,90	84
1225060060	1" ONİKİ KÖŞE 60 MM LOKMA	434,45	83	1513067003	1/2"Fx3/4" M HAVALI LOKMA ADAPTÖRÜ	71,80	84
1413060024	1/2" ONİKİ KÖŞE LOKMA ANAHTAR TAKIMI 24 PARÇA SAE	1.012,30	79	1513067075	1/2" HAVALI LOKMA MAFSAL 75 MM	120,75	84
1413061008	1/2" ONİKİ KÖŞE 5/16" SAE LOKMA ANAHTAR	27,00	73	1513067125	1/2" HAVALI LOKMA ARA KOL 125 MM	95,10	84
1413061010	1/2" ONİKİ KÖŞE 7/16 SAE LOKMA ANAHTAR	27,95	73	1513067250	1/2" HAVALI LOKMA ARA KOL 250 MM	128,45	84
1413061011	1/2" ONİKİ KÖŞE 15/32 SAE LOKMA ANAHTAR	27,95	73	1514064025	ELTA 1/2" T KOL 250 MM	63,45	186
1413061012	1/2" ONİKİ KÖŞE 1/2 SAE LOKMA ANAHTAR	29,05	73	1514064065	ELTA 1/2" MAFSAL 65 MM	47,55	186
1413061013	1/2" ONİKİ KÖŞE 9/16 SAE LOKMA ANAHTAR	30,10	73	1514064125	ELTA 1/2" ARA KOL 125 MM	33,25	186
1413061014	1/2" ONİKİ KÖŞE 19/32 SAE LOKMA ANAHTAR	30,10	73	1514064250	ELTA 1/2" ARA KOL 250 MM	57,65	186
1413061015	1/2" ONİKİ KÖŞE 5/8 SAE LOKMA ANAHTAR	30,40	73	1514064420	ELTA 1/2" U KOL 420 MM	92,15	187
1413061016	1/2" ONİKİ KÖŞE 11/16 SAE LOKMA ANAHTAR	31,45	73	1514065250	ELTA 1/2" CİRCİR KOLU 250 MM	135,15	187
1413061017	1/2" ONİKİ KÖŞE 3/4 SAE LOKMA ANAHTAR	31,75	73	1514066250	ELTA 1/2" T KOL ADAPTÖRÜ	36,30	186
1413061020	1/2" ONİKİ KÖŞE 25/32 SAE LOKMA ANAHTAR	32,85	73	1514067125	ELTA 1/2" HAVALI LOKMA ARA KOL 125 MM	41,35	188
1413061021	1/2" ONİKİ KÖŞE 13/16 SAE LOKMA ANAHTAR	32,85	73	1514067250	ELTA 1/2" HAVALI LOKMA ARA KOL 250 MM	56,95	188
1413061022	1/2" ONİKİ KÖŞE 7/8 SAE LOKMA ANAHTAR	32,85	73	1519060001	3/4"Fx1" M LOKMA ADAPTÖRÜ	76,90	82
1413061024	1/2" ONİKİ KÖŞE 15/16 SAE LOKMA ANAHTAR	34,30	73	1519060008	3/4"Fx1/2" M LOKMA ADAPTÖRÜ	56,85	82
1413061025	1/2" ONİKİ KÖŞE 1" SAE LOKMA ANAHTAR	34,30	73	1519064200	3/4" ARA KOL 200 MM	132,55	81
1413061027	1/2" ONİKİ KÖŞE 1 1/16 SAE LOKMA ANAHTAR	44,95	73	1519064400	3/4" ARA KOL 400 MM	240,10	81
1413061029	1/2" ONİKİ KÖŞE 1 1/8 SAE LOKMA ANAHTAR	44,95	73	1519064500	3/4" T KOL 500 MM	267,20	82
1413061030	1/2" ONİKİ KÖŞE 1 3/16 SAE LOKMA ANAHTAR	44,95	73	1519064510	3/4" CİRCİR KOLU 510 MM	541,50	81
1413061032	1/2" ONİKİ KÖŞE 1 1/4 SAE LOKMA ANAHTAR	44,95	73	1519067011	3/4"FX1/2" M HAVALI LOKMA ADAPTÖRÜ 3/4"	119,75	85
1413061095	1/2" ONİKİ KÖŞE 3/8 SAE LOKMA ANAHTAR	27,00	73	1519067108	3/4" HAVALI LOKMA MAFSAL 108 MM	345,65	85
1419006114	3/4" ON İKİ KÖŞE LOKMA ANAHTAR TAKIMI 14 PARÇA SAE	2.234,75	82	1519067175	3/4" HAVALI LOKMA ARA KOL 175 MM	207,50	85

KOD	ÜRÜN	FİYAT	SAYFA	KOD	ÜRÜN	FİYAT	SAYFA
1519067250	3/4" HAVALI LOKMA ARA KOL 250 MM	296,75	85	1870093032	AGIR TİP BİJON ANAHTARI İKİ AĞIZ UZUN 30X32 MM	122,60	87
1519067330	3/4" HAVALI LOKMA ARA KOL 330 MM	450,35	85	1870093233	AGIR TİP BİJON ANAHTARI İKİ AĞIZ UZUN 32X33 MM	136,05	87
1521064200	ELTA 3/4" ARA KOL 200 MM	117,90	188	1874092224	AGIR TİP BİJON ANAHTARI İKİ AĞIZ KISA 22X24 MM	65,30	87
1521064400	ELTA 3/4" ARA KOL 400 MM	209,45	188	1874092427	AGIR TİP BİJON ANAHTARI İKİ AĞIZ KISA 24X27 MM	83,50	87
1521064500	ELTA 3/4" T KOL 500 MM	225,25	188	1875092224	ELTA AĞIR TİP BİJON ANAHTARI İKİ AĞIZ UZUN 22X24 MM	95,10	185
1521067108	ELTA 3/4" HAVALI LOKMA MAFSAL 108 MM	141,00	189	1940090017	BİJON ANAHTARI PİPO TİPİ 17 MM (TORNAVİDA AĞIZLI)	51,60	88
1521067175	ELTA 3/4" HAVALI LOKMA ARA KOL 175 MM	81,05	189	1940090019	BİJON ANAHTARI PİPO TİPİ 19 MM (TORNAVİDA AĞIZLI)	54,50	88
1521067250	ELTA 3/4" HAVALI LOKMA ARA KOL 250 MM	104,45	189	1940090021	BİJON ANAHTARI PİPO TİPİ 21 MM (TORNAVİDA AĞIZLI)	67,35	88
1521067330	ELTA 3/4" HAVALI LOKMA ARA KOL 330 MM	134,00	189	1975091322	1/2" ADAPTÖRLÜ BİJON ANAHTARI İSTAVROZ TİPİ	125,50	88
1525060005	1"FX3/4"M LOKMA ADAPTÖRÜ	109,70	83	1975091719	BİJON ANAHTARI İSTAVROZ TİPİ 17X19-21(13/16)X22	123,25	88
1525067015	1"FX3/4"M HAVALI LOKMA ADAPTÖRÜ	144,80	86	2100100008	STİLSON BORU ANAHTARI 8"	150,95	93
1525067128	1" HAVALI LOKMA MAFSAL 128 MM	705,85	86	2100100010	STİLSON BORU ANAHTARI 10"	194,50	93
1525067175	1" HAVALI LOKMA ARA KOL 175 MM	377,65	86	2100100012	STİLSON BORU ANAHTARI 12"	218,80	93
1525067250	1" HAVALI LOKMA ARA KOL 250 MM	485,70	86	2100100014	STİLSON BORU ANAHTARI 14"	250,70	93
1525067330	1" HAVALI LOKMA ARA KOL 330 MM	589,60	86	2100100018	STİLSON BORU ANAHTARI 18"	341,00	93
1607060420	1/4" CİRCİRLİ TORK ANAHTAR 4-20 Nm	1.112,60	89	2100100024	STİLSON BORU ANAHTAR 24"	549,40	93
1610060100	3/8" TORK ANAHTAR 2.5-11 Nm	1.405,55	89	2100100108	8" STİLSON BORU ANAHTARI YEDEK PARÇASI ÇENE	47,55	200
1610060300	3/8" TORK ANAHTAR 7-33 Nm	1.453,10	89	2100100110	10" STİLSON BORU ANAHTARI YEDEK PARÇASI ÇENE	70,50	200
1610062010	3/8" CİRCİRLİ TORK ANAHTAR 20-100 Nm	1.256,15	89	2100100112	12" STİLSON BORU ANAHTARI YEDEK PARÇASI ÇENE	78,65	200
1613061200	1/2" TORK ANAHTAR 25-135 Nm	1.500,65	89	2100100114	14" STİLSON BORU ANAHTARI YEDEK PARÇASI ÇENE	94,85	200
1613062000	1/2" TORK ANAHTAR 50-225 Nm	1.548,95	89	2100100118	18" STİLSON BORU ANAHTARI YEDEK PARÇASI ÇENE	127,55	200
1613063000	1/2" TORK ANAHTAR 70-330 Nm	1.884,80	89	2100100124	24" STİLSON BORU ANAHTARI YEDEK PARÇASI ÇENE	182,70	200
1613064020	1/2" CİRCİRLİ TORK ANAHTARI 40-200 Nm	1.287,50	89	2100100208	8" STİLSON BORU ANAHTARI YEDEK BAĞLANTI PARÇASI	72,95	200
1613066034	1/2" CİRCİRLİ TORK ANAHTARI 60-340 Nm	1.349,80	89	2100100210	10" STİLSON BORU ANAHTARI YEDEK BAĞLANTI PARÇASI	108,30	200
1619061060	3/4" CİRCİRLİ TORK ANAHTAR 100-600 Nm	5.080,00	89	2100100212	12" STİLSON BORU ANAHTARI YEDEK BAĞLANTI PARÇASI	118,65	200
1619062080	3/4" TORK ANAHTAR 200-800 Nm	8.808,25	89	2100100214	14" STİLSON BORU ANAHTARI YEDEK BAĞLANTI PARÇASI	143,30	200
1800002108	8 LI KOVAN ANAHTAR TAKIMI	338,75	87	2100100218	18" STİLSON BORU ANAHTARI YEDEK BAĞLANTI PARÇASI	164,20	200
1800070607	KOVAN ANAHTAR İKİ AĞIZ 06x07 MM	24,30	87	2100100224	24" STİLSON BORU ANAHTARI YEDEK BAĞLANTI PARÇASI	245,50	200
1800070809	KOVAN ANAHTAR İKİ AĞIZ 08x09 MM	26,70	87	2100100308	8" STİLSON BORU ANAHTARI YEDEK PARÇASI SOMUN	35,30	200
1800071011	KOVAN ANAHTAR İKİ AĞIZ 10x11 MM	36,65	87	2100100310	10" STİLSON BORU ANAHTARI YEDEK PARÇASI SOMUN	38,95	200
1800071213	KOVAN ANAHTAR İKİ AĞIZ 12x13 MM	38,85	87	2100100312	12" STİLSON BORU ANAHTARI YEDEK PARÇASI SOMUN	40,70	200
1800071415	KOVAN ANAHTAR İKİ AĞIZ 14x15 MM	42,60	87	2100100314	14" STİLSON BORU ANAHTARI YEDEK PARÇASI SOMUN	45,40	200
1800071617	KOVAN ANAHTAR İKİ AĞIZ 16x17 MM	45,75	87	2100100318	18" STİLSON BORU ANAHTARI YEDEK PARÇASI SOMUN	62,75	200
1800071819	KOVAN ANAHTAR İKİ AĞIZ 18x19 MM	47,40	87	2100100324	24" STİLSON BORU ANAHTARI YEDEK PARÇASI SOMUN	68,60	200
1800072022	KOVAN ANAHTAR İKİ AĞIZ 20x22 MM	52,25	87	2110100008	AĞIR TİP BORU ANAHTARI 8"	203,60	93
1800072123	KOVAN ANAHTAR İKİ AĞIZ 21x23 MM	56,30	87	2110100010	AĞIR TİP BORU ANAHTARI 10"	252,75	93
1800072224	KOVAN ANAHTAR İKİ AĞIZ 22x24 MM	58,65	87	2110100012	AĞIR TİP BORU ANAHTARI 12"	289,50	93
1800072426	KOVAN ANAHTAR İKİ AĞIZ 24x26 MM	73,05	87	2110100014	AGIR TİP BORU ANAHTARI 14"	337,00	93
1800072427	KOVAN ANAHTAR İKİ AĞIZ 24x27 MM	75,85	87	2110100018	AĞIR TİP BORU ANAHTARI 18"	470,15	93
1800072528	KOVAN ANAHTAR İKİ AĞIZ 25x28 MM	85,95	87	2110100024	AĞIR TİP BORU ANAHTARI 24"	758,20	93
1800072732	KOVAN ANAHTAR İKİ AĞIZ 27x32 MM	100,00	87	2110100036	AĞIR TİP BORU ANAHTARI 36"	1.679,50	93
1801070607	ELTA KOVAN ANAHTAR İKİ AĞIZ 06X07 MM	18,90	185	2110100048	AĞIR TİP BORU ANAHTARI 48"	3.439,80	93
1801072022	ELTA KOVAN ANAHTAR İKİ AĞIZ 20X22 MM	40,40	185	2110100108	8" AĞIR TİP BORU ANAHTARI YEDEK PARÇASI ÇENE	84,15	200
1801072123	ELTA KOVAN ANAHTAR İKİ AĞIZ 21X23 MM	45,20	185	2110100110	10" AĞIR TİP BORU ANAHTARI YEDEK PARÇASI ÇENE	102,30	200
1801072426	ELTA KOVAN ANAHTAR İKİ AĞIZ 24X26 MM	58,60	185	2110100112	12" AĞIR TİP BORU ANAHTARI YEDEK PARÇASI ÇENE	201,85	200
1801072528	ELTA KOVAN ANAHTAR İKİ AĞIZ 25X28 MM	68,95	185	2110100114	14" AĞIR TİP BORU ANAHTARI YEDEK PARÇASI ÇENE	215,30	200
1801072732	ELTA KOVAN ANAHTAR İKİ AĞIZ 27X32 MM	80,25	185	2110100118	18" AĞIR TİP BORU ANAHTARI YEDEK PARÇASI ÇENE	228,75	200
1840080500	1/2" MAFSALLI T KOL 500 MM	253,85	88	2110100124	24" AĞIR TİP BORU ANAHTARI YEDEK PARÇASI ÇENE	343,15	200
1841070021	KOVAN ANAHTAR BİR AĞIZ MİL DAHİL 21 MM	39,10	87	2110100136	36" AĞIR TİP BORU ANAHTARI YEDEK PARÇASI ÇENE	686,25	200
1845080160	MAFSALLI BUJİ LOKMA 16 MM	310,55	88	2110100148	48" AĞIR TİP BORU ANAHTARI YEDEK PARÇASI ÇENE	1.130,25	200
1845080208	MAFSALLI BUJİ LOKMA 20.8 MM	377,80	88	2110100308	8" AĞIR TİP BORU ANAHTARI YEDEK PARÇASI SOMUN	27,65	200
1850071120	KOVAN ANAHTAR MİLİ 10X120 MMM	16,65	87	2110100310	10" AĞIR TİP BORU ANAHTARI YEDEK PARÇASI SOMUN	29,00	200
1850071200	KOVAN ANAHTAR MİLİ 10x200 MM	18,75	87	2110100312	12" AĞIR TİP BORU ANAHTARI YEDEK PARÇASI SOMUN	31,65	200
1850075125	KOVAN ANAHTAR MİLİ 5x125 MM	9,60	87	2110100314	14" AĞIR TİP BORU ANAHTARI YEDEK PARÇASI SOMUN	38,40	200
1850078180	KOVAN ANAHTAR MİLİ 8x180 MM	14,65	87	2110100318	18" AĞIR TİP BORU ANAHTARI YEDEK PARÇASI SOMUN	51,15	200
1850091630	BİJON ANAHTAR MİLİ 18x630 MM	60,00	87	2110100324	24" AĞIR TİP BORU ANAHTARI YEDEK PARÇASI SOMUN	78,05	200
1855080008	MAFSALLI T KOL LOKMA 8 MM	254,90	88	2110100336	36" AĞIR TİP BORU ANAHTARI YEDEK PARÇASI SOMUN	144,70	200
1855080010	MAFSALLI T KOL LOKMA 10 MM	320,55	88	2110100348	48" AĞIR TİP BORU ANAHTARI YEDEK PARÇASI SOMUN	232,15	200
1855080012	MAFSALLI T KOL LOKMA 12 MM	320,55	88	2110100408	8" AĞIR TİP BORU ANAHTARI YEDEK PARÇASI ALT ÇENE VE PİM	86,15	200
1855080013	MAFSALLI T KOL LOKMA 13 MM	320,55	88	2110100410	10" AĞIR TİP BORU ANAHTARI YEDEK PARÇASI ALT ÇENE VE PİM	95,55	200
1855080017	MAFSALLI T KOL LOKMA 17 MM	357,05	88	2110100412	12" AĞIR TİP BORU ANAHTARI YEDEK PARÇASI ALT ÇENE VE PİM	107,65	200
1855080019	MAFSALLI T KOL LOKMA 19 MM	453,85	88	2110100414	14" AĞIR TİP BORU ANAHTARI YEDEK PARÇASI ALT ÇENE VE PİM	111,05	200
1857080013	T KOL LOKMA 13 MM	127,85	88	2110100418	18" AĞIR TİP BORU ANAHTARI YEDEK PARÇASI ALT ÇENE VE PİM	115,00	200
1857080017	T KOL LOKMA 17 MM	163,55	88	2110100424	24" AĞIR TİP BORU ANAHTARI YEDEK PARÇASI ALT ÇENE VE PİM	126,50	200
1870092427	AGIR TİP BİJON ANAHTAR İKİ AĞIZ UZUN 24X27 MM	103,10	87	2110100436	36" AĞIR TİP BORU ANAHTARI YEDEK PARÇASI ALT ÇENE VE PİM	201,85	200
1870092730	AGIR TİP BİJON ANAHTARI İKİ AĞIZ UZUN 27X30 MM	118,50	87	2110100448	48" AĞIR TİP BORU ANAHTARI YEDEK PARÇASI ALT ÇENE VE PİM	272,50	200
1870092732	AGIR TİP BİJON ANAHTARI İKİ AĞIZ UZUN 27X32 MM	118,50	87	2200100005	1/2" MAŞALI BORU ANAHTAR (45)	194,95	93

KOD	ÜRÜN	FİYAT	SAYFA
2200100010	1" MAŞALI BORU ANAHTAR (45)	231,50	93
2200100015	1 1/2" MAŞALI BORU ANAHTARI (45)	327,00	93
2200100020	2" MAŞALI BORU ANAHTARI (45)	520,85	93
2201100010	1" MAŞALI BORU ANAHTARI (85)	151,30	93
2201100015	1 1/2" MAŞALI BORU ANAHTARI (85)	234,30	93
2201100020	2" MAŞALI BORU ANAHTARI (85)	350,85	93
2201100030	3" MAŞALI BORU ANAHTARI (85)	531,90	93
2201100040	4" MAŞALI BORU ANAHTARI (85)	797,80	93
2201100110	1" MAŞALI BORU ANAHTARI YEDEK PARÇASI SOMUN	8,10	200
2201100115	1 1/2" MAŞALI BORU ANAHTARI YEDEK PARÇASI SOMUN	10,20	200
2201100120	2" MAŞALI BORU ANAHTARI YEDEK PARÇASI SOMUN	13,60	200
2201100130	3" MAŞALI BORU ANAHTARI YEDEK PARÇASI SOMUN	18,20	200
2201100140	4" MAŞALI BORU ANAHTARI YEDEK PARÇASI SOMUN	21,40	200
2202100010	1" İSVEÇ TİP MAŞALI BORU ANAHTAR	235,45	93
2202100015	1 1/2" İSVEÇ TİP MAŞALI BORU ANAHTAR	340,40	93
2202100020	2" İSVEÇ TİP MAŞALI BORU ANAHTAR	524,95	93
2203100010	ELTA MAŞALI BORU ANAHTARI 1" (85°)	126,20	189
2203100015	ELTA MAŞALI BORU ANAHTARI 1" 1/2 (85°)	194,00	189
2203100020	ELTA MAŞALI BORU ANAHTARI 2" (85°)	289,25	189
2203100030	ELTA MAŞALI BORU ANAHTARI 3" (85°)	443,30	189
2300101015	ZİNCİRLİ BORU ANAHTARI YEDEK ZİNCİRİ 1 1/2" (300)	224,30	200
2300101120	ZİNCİRLİ BORU ANAHTARI YEDEK ZİNCİRİ 12" (1500)	2.347,15	200
2350006104	DEMİR KESME MAKASI SEHPASI (DOLU)	3.500,05	167
2350270018	DEMİR KESME MAKASI 18"(450)	375,70	167
2350270024	DEMİR KESME MAKASI 24"(600)	553,05	167
2350270030	DEMİR KESME MAKASI 30"(750)	865,80	167
2350270036	DEMİR KESME MAKASI 36" (900)	1.120,50	167
2350270118	18" DEMİR KESME MAKASI YEDEK ÇENE (450)	193,30	200
2350270124	24" DEMİR KESME MAKASI YEDEK ÇENE (600)	221,55	200
2350270130	30" DEMİR KESME MAKASI YEDEK ÇENE (750)	392,20	200
2350270136	36" DEMİR KESME MAKASI YEDEK ÇENE (900)	724,25	200
2350316104	DEMİR KESME MAKASI SEHPASI (BOŞ)	585,00	206
2400110160	ÜNİVERSAL FORT PENSE 160 MM	100,80	94
2400110240	ÜNİVERSAL FORT PENSE 240 MM	140,95	94
2400110315	ÜNİVERSAL FORT PENSE 315 MM	230,90	94
2400116240	1000V İZOLELİ ÜNİVERSAL FORT PENSE 240 MM	163,55	94
2401110240	ELTA FORT PENSE 240 MM	125,20	189
2415110240	YAYLI FORT PENSE 240 MM	190,20	94
2500110250	ÜNİVERSAL AYARLI PENSE 250 MM	165,35	95
2505110250	STANDART AYARLI PENSE 250 MM	165,35	95
2509110225	ELTA AYARLI PENSE 225 MM	118,85	189
2510110250	SPECIAL AYARLI PENSE 250 MM	165,35	95
2511110280	C TİPİ AYARLI PENSE 280 MM	241,90	95
2512110200	KAYNAKÇI AYARLI PENSE 200MM (DÜZ AĞIZ)	244,15	96
2513110280	KAYNAKÇI AYARLI PENSE 280 MM (BORU İÇİN)	244,15	96
2515110270	KAPORTACI AYARLI PENSE 270 MM	221,45	96
3020001002	PENSE VE KONTROL KALEMİ 2'Lİ SET (ANAHTARLIKLİ)	110,05	99
3020002003	160 MM OPAK SETİ (3 PARÇA)	291,55	99
3020006003	160 MM ELEKTRİKÇİ İZOLELİ 1000 V SETİ (3 PARÇA)	409,45	116
3020122160	KOMBİNE PENSE OPAK SERİ 160 MM	87,60	97
3020122180	KOMBİNE PENSE OPAK SERİ 180 MM	99,40	97
3020122200	KOMBİNE PENSE OPAK SERİ 200 MM	112,25	97
3020123160	KOMBİNE PENSE KRAFT 160 MM	107,35	97
3020123180	KOMBİNE PENSE KRAFT SERİ 180 MM	119,95	97
3020123200	KOMBİNE PENSE KRAFT SERİ 200 MM	135,50	97
3020125160	KOMBİNE PENSE ERGONOMİK SERİ 160 MM	110,20	97
3020125180	KOMBİNE PENSE ERGONOMİK SERİ 180 MM	125,15	97
3020125200	KOMBİNE PENSE ERGONOMİK SERİ 200 MM	141,30	97
3020126160	1000V İZOLELİ ELEKTRİKÇİ KOMBİNE PENSE 160 MM	120,65	97
3020126180	1000V İZOLELİ ELEKTRİKÇİ KOMBİNE PENSE 180 MM	129,15	97
3020126200	1000V İZOLELİ ELEKTRİKÇİ KOMBİNE PENSE 200 MM	145,80	97
3021121160	ELTA KOMBİNE PENSE OPAK 160 MM	67,00	190
3021121180	ELTA KOMBİNE PENSE OPAK 180 MM	82,00	190
3021121200	ELTA KOMBİNE PENSE OPAK 200 MM	99,95	190
3030122180	KOMBİNE PENSE AĞIR TİP 180 MM (ÇELİK TEL İÇİN)	149,80	97
3030122200	KOMBİNE PENSE AĞIR TİP 200 MM (ÇELİK TEL İÇİN)	171,30	97
3220132140	140 MM KARGABURUN DÜZ UÇLU OPAK	86,30	98

KOD	ÜRÜN	FİYAT	SAYFA
3220132160	160 MM KARGABURUN DÜZ UÇLU OPAK	97,55	98
3220132180	180 MM KARGABURUN DÜZ UÇLU OPAK	107,20	98
3220132200	200 MM KARGABURUN DÜZ UÇLU OPAK	113,70	98
3220133140	140 MM KARGABURUN DÜZ UÇLU KRAFT	106,55	98
3220133160	160 MM KARGABURUN DÜZ UÇLU KRAFT	120,25	98
3220133180	180 MM KARGABURUN DÜZ UÇLU KRAFT	132,30	98
3220133200	200 MM KARGABURUN DÜZ UÇLU KRAFT	140,25	98
3220135140	140 MM KARGABURUN DÜZ UÇLU ERGONOMİK	112,10	98
3220135160	160 MM KARGABURUN DÜZ UÇLU ERGONOMİK	126,75	98
3220135180	180 MM KARGABURUN DÜZ UÇLU ERGONOMİK	139,30	98
3220135200	200 MM KARGABURUN DÜZ UÇLU ERGONOMİK	147,60	98
3220136140	140 MM DÜZ KARGABURUN ELEKTRİKÇİ İZOLELİ 1000 V	123,45	98
3220136160	160 MM DÜZ KARGABURUN ELEKTRİKÇİ İZOLELİ 1000 V	136,50	98
3220136180	180 MM DÜZ KARGABURUN ELEKTRİKÇİ İZOLELİ 1000 V	153,20	98
3220136200	200 MM DÜZ KARGABURUN ELEKTRİKÇİ İZOLELİ 1000 V	159,10	98
3221131160	ELTA KARGABURUN DÜZ UÇLU OPAK 160 MM	72,70	190
3221131200	ELTA KARGABURUN DÜZ UÇLU OPAK 200 MM	83,25	190
3225132160	160 MM KARGABURUN EĞRİ UÇLU OPAK	103,05	99
3225132180	180 MM KARGABURUN EĞRİ UÇLU OPAK	116,45	99
3225132200	200 MM KARGABURUN EĞRİ UÇLU OPAK	124,45	99
3225133160	160 MM KARGABURUN EĞRİ UÇLU KRAFT	123,95	99
3225133180	180 MM KARGABURUN EĞRİ UÇLU KRAFT	136,10	99
3225133200	200 MM KARGABURUN EĞRİ UÇLU KRAFT	149,75	99
3301120140	DIŞ SEGMAN PENSE 140 MM YAYLI DÜZ	103,00	103
3301120180	DIŞ SEGMAN PENSE 180 MM YAYLI DÜZ	108,55	103
3301120225	DIŞ SEGMAN PENSE 225 MM YAYLI DÜZ	135,70	103
3301120295	DIŞ SEGMAN PENSE 295 MM YAYLI DÜZ	230,15	103
3303120140	ELTA DIŞ SEGMAN PENSE 140 MM YAYLI DÜZ	71,70	190
3303120180	ELTA DIŞ SEGMAN PENSE 180 MM YAYLI DÜZ	75,55	190
3303120220	ELTA DIŞ SEGMAN PENSE 220 MM YAYLI DÜZ	90,40	190
3304120125	ELTA DIŞ SEGMAN PENSE 125 MM YAYLI EĞRİ	80,00	190
3304120200	ELTA DIŞ SEGMAN PENSE 200 MM YAYLI EĞRİ	100,45	190
3310120170	ÇAKMA UÇLU DIŞ SEGMAN PENSE 170 MM EĞRİ	105,15	103
3311120125	DIŞ SEGMAN PENSE 125 MM YAYLI EĞRİ	115,10	103
3311120170	DIŞ SEGMAN PENSE 170 MM YAYLI EĞRİ	121,25	103
3311120210	DIŞ SEGMAN PENSE 210 MM YAYLI EĞRİ	139,30	103
3311120275	DIŞ SEGMAN PENSE 275 MM YAYLI EĞRİ	241,65	103
3320120140	ÇAKMA UÇLU İÇ SEGMAN PENSE 140 MM DÜZ	82,20	103
3320120225	ÇAKMA UÇLU İÇ SEGMAN PENSE 225 MM DÜZ	108,05	103
3321120140	İÇ SEGMAN PENSE 140 MM YAYSIZ DÜZ	94,80	103
3321120180	İÇ SEGMAN PENSE 180 MM YAYSIZ DÜZ	100,05	103
3321120225	İÇ SEGMAN PENSE 225 MM YAYSIZ DÜZ	124,55	103
3321120310	İÇ SEGMAN PENSE 310 MM YAYSIZ DÜZ	213,75	103
3323120140	ELTA İÇ SEGMAN PENSE 140 MM YAYSIZ DÜZ	65,90	190
3323120180	ELTA İÇ SEGMAN PENSE 180 MM YAYSIZ DÜZ	69,50	190
3323120230	ELTA İÇ SEGMAN PENSE 230 MM YAYSIZ DÜZ	98,00	190
3324120130	ELTA İÇ SEGMAN PENSE 130 MM YAYSIZ EĞRİ	70,80	191
3324120170	ELTA İÇ SEGMAN PENSE 170 MM YAYSIZ EĞRİ	74,60	191
3324120210	ELTA İÇ SEGMAN PENSE 210 MM YAYSIZ EĞRİ	89,00	191
3331120130	İÇ SEGMAN PENSE 130 MM YAYSIZ EĞRİ	101,95	103
3331120170	İÇ SEGMAN PENSE 170 MM YAYSIZ EĞRİ	107,30	103
3331120210	İÇ SEGMAN PENSE 210 MM YAYSIZ EĞRİ	133,95	103
3331120290	İÇ SEGMAN PENSE 290 MM YAYSIZ EĞRİ	229,95	103
3335001004	İZELTAS SEGMAN PENSE SETİ 4 PARÇA	437,15	102
3400120275	SÜBAP SEGMAN PENSE 275 MM	231,40	104
3405120225	PİSTON SEGMAN PENSE 265 MM	161,80	104
3415120320	FREN YAY PENSESİ 320 MM	229,45	104
3415120525	FREN YAY PENSESİ 525 MM	531,10	104
3420120220	HORTUM KELEPÇE PENSE 220 MM	177,55	104
3425120220	HORTUM KELEPÇE PENSE SIKIŞTIRMA TİPİ 235 MM	181,95	104
3550140125	ELEKTRONİKÇİ YAN KESKİ 125 MM	113,15	107
3551140125	ELEKTRONİKÇİ TEPE KESKİ 125 MM	113,15	107
3552140125	ELEKTRONİKÇİ YUVARLAK UÇLU KARGABURUN 125 MM	113,15	107
3553140150	ELEKTRONİKÇİ DÜZ UÇLU KARGABURUN 150 MM	112,85	107
3554140150	ELEKTRONİKÇİ UZUN KARGABURUN 150 MM	112,85	107
3555140150	ELEKTRONİKÇİ SIVRI UÇLU DÜZ KARGABURUN 150 MM	112,85	107
3556140150	ELEKTRONİKÇİ SIVRI UÇLU EĞRİ KARGABURUN 150 MM	112,85	108

KOD	ÜRÜN	FİYAT	SAYFA	KOD	ÜRÜN	FİYAT	SAYFA
3557140125	ELEKTRONİKÇİ PENSE 125 MM	113,15	108	4100178175	KRAFT SERİ DÜZ UÇLU TORNAVIDA 8x175	42,85	124
3560002104	ELEKTRONİKÇİ KESKİ VE PENSE SETİ 4 PARÇA	452,30	108	4100178200	KRAFT SERİ DÜZ UÇLU TORNAVIDA 8x200	52,45	124
3565002104	ELEKTRONİKÇİ KARGABURUN SETİ 4 PARÇA	451,70	108	4100179200	KRAFT SERİ DÜZ UÇLU TORNAVIDA 9x200	55,95	124
3700162140	YAN KESKİ OPAK SERİ 140 MM	88,40	100	4101172575	SÜNGÜSÜ İZOLELİ DÜZ UÇLU TORNAVIDA 2.5X75	16,40	127
3700162160	YAN KESKİ OPAK SERİ 160 MM	106,40	100	4101174100	SÜNGÜSÜ İZOLELİ DÜZ UÇLU TORNAVIDA 4x100	20,75	127
3700162180	YAN KESKİ OPAK SERİ 180 MM	124,15	100	4101175512	SÜNGÜSÜ İZOLELİ DÜZ UÇLU TORNAVIDA 5.5x125	28,70	127
3700163140	YAN KESKİ KRAFT SERİ 140 MM	106,60	100	4101176515	SÜNGÜSÜ İZOLELİ DÜZ UÇLU TORNAVIDA 6.5x150	31,20	127
3700163160	YAN KESKİ KRAFT SERİ 160 MM	128,10	100	4110170425	KRAFT SERİ DÜZ UÇLU TOPAÇ TORNAVIDA 4X25	13,15	126
3700163180	YAN KESKİ KRAFT SERİ 180 MM	149,25	100	4110170825	KRAFT SERİ DÜZ UÇLU TOPAÇ TORNAVIDA 8X25	18,40	126
3700165140	YAN KESKİ ERGONOMİK SERİ 140 MM	115,00	100	4110175525	KRAFT SERİ DÜZ UÇLU TOPAÇ TORNAVIDA 5.5X25	17,45	126
3700165160	YAN KESKİ ERGONOMİK SERİ 160 MM	132,95	100	4110175540	KRAFT SERİ DÜZ UÇLU TOPAÇ TORNAVIDA 5.5x40	23,60	126
3700165180	YAN KESKİ ERGONOMİK SERİ 180 MM	155,05	100	4110176525	KRAFT SERİ DÜZ UÇLU TOPAÇ TORNAVIDA 6.5X25	19,40	126
3700166140	1000V İZOLELİ ELEKTRİKÇİ YAN KESKİ 140 MM	134,15	100	4110176540	KRAFT SERİ DÜZ UÇLU TOPAÇ TORNAVIDA 6.5X40	26,75	126
3700166160	1000V İZOLELİ ELEKTRİKÇİ YAN KESKİ 160 MM	152,30	100	4120008106	KRAFT SERİ YILDIZ UÇLU TORNAVIDA SETİ 6 PARÇA	166,30	125
3700166180	1000V İZOLELİ ELEKTRİKÇİ YAN KESKİ 180 MM	170,40	100	4120180360	KRAFT SERİ YILDIZ UÇLU TORNAVIDA 3x60	17,00	125
3701161140	ELTA YAN KESKİ OPAK 140 MM	61,70	190	4120181200	KRAFT SERİ YILDIZ UÇLU TORNAVIDA 10x200	86,65	125
3701161160	ELTA YAN KESKİ OPAK 160 MM	72,50	190	4120184580	KRAFT SERİ YILDIZ UÇLU TORNAVIDA 4.5x80	24,50	125
3705165160	İNCE UÇLU YAN KESKİ (PLASTİKLER İÇİN) 160 MM	138,50	102	4120185100	KRAFT SERİ YILDIZ UÇLU TORNAVIDA 4.5x100	27,30	125
3715160165	TEK AĞIZLI KABLO KESİCİ 165MM	114,05	105	4120185150	KRAFT SERİ YILDIZ UÇLU TORNAVIDA 4.5x150	32,65	125
3715166165	1000V İZOLELİ TEK AĞIZLI KABLO KESİCİ 165MM	134,55	105	4120185300	KRAFT SERİ YILDIZ UÇLU TORNAVIDA 4.5x300	77,35	125
3720160220	ÇİFT AĞIZLI KABLO KESİCİ 220 MM	152,95	106	4120186100	KRAFT SERİ YILDIZ UÇLU TORNAVIDA 6x100	29,50	125
3730162160	YAN KESKİ AĞIR TİP 160 MM (ÇELİK TEL İÇİN)	151,00	102	4120186150	KRAFT SERİ YILDIZ UÇLU TORNAVIDA 6X150	35,35	125
3730162200	YAN KESKİ AĞIR TİP 200 MM (ÇELİK TEL İÇİN)	196,25	102	4120186200	KRAFT SERİ YILDIZ UÇLU TORNAVIDA 6x200	45,90	125
3800150160	KERPETEN 160 MM	84,15	109	4120186300	KRAFT SERİ YILDIZ UÇLU TORNAVIDA 6x300	80,00	125
3800150180	KERPETEN 180 MM	87,05	109	4120188150	KRAFT SERİ YILDIZ UÇLU TORNAVIDA 8x150	56,00	125
3800150200	KERPETEN 200 MM	116,10	109	4121180360	SÜNGÜSÜ İZOLELİ YILDIZ UÇLU TORN. 3x60	19,45	127
3800150250	KERPETEN 250 MM	126,50	109	4121184580	SÜNGÜSÜ İZOLELİ YILDIZ UÇLU TORN. 4.5x80	26,00	127
3801150160	ELTA KERPETEN 160 MM	68,00	191	4121186100	SÜNGÜSÜ İZOLELİ YILDIZ UÇLU TORN. 6x100	31,60	127
3801150180	ELTA KERPETEN 180 MM	73,45	191	4130180625	KRAFT SERİ YILDIZ UÇLU TOPAÇ TORNAVIDA 6x25	19,50	126
3801150200	ELTA KERPETEN 200 MM	88,85	191	4130180640	KRAFT SERİ YILDIZ UÇLU TOPAÇ TORNAVIDA 6x40	26,40	126
3830150225	BETONCU KERPETEN 225 MM	104,45	109	4130184525	KRAFT SERİ YILDIZ UÇLU TOPAÇ TORNAVIDA 4.5X25	18,55	126
3830150250	BETONCU KERPETEN 250 MM	115,40	109	4130184540	KRAFT SERİ YILDIZ UÇLU TOPAÇ TORNAVIDA 4.5x40	23,50	126
3830150280	BETONCU KERPETEN 280 MM	129,15	109	4140009106	1000V İZOLELİ ELEKTRİKÇİ TORNAVIDA SETİ 6 PARÇA	168,00	127
3831150280	BETONCU KERPETEN YAYLI 280 MM	148,15	109	4140172575	1000V İZOLELİ ELEKTRİKÇİ DÜZ UÇLU TORNAVIDA 2.5X75	19,40	127
3832150225	ELTA BETONCU KERPETENİ 225 MM	82,00	191	4140174100	1000V İZOLELİ ELEKTRİKÇİ DÜZ UÇLU TORNAVIDA 4X100	22,80	127
3832150250	ELTA BETONCU KERPETENİ 250 MM	93,45	191	4140175512	1000V İZOLELİ ELEKTRİKÇİ DÜZ UÇLU TORNAVIDA 5.5X125	30,05	127
3832150280	ELTA BETONCU KERPETENİ 280 MM	113,35	191	4140176515	1000V İZOLELİ ELEKTRİKÇİ DÜZ UÇLU TORNAVIDA 6.5X150	33,60	127
3835150280	AĞIR TİP BETONCU KERPETENİ 280 MM	146,85	109	4145180360	1000V İZOLELİ ELEKTRİKÇİ YILDIZ UÇLU TORNAVIDA 3X60	20,20	127
3850120200	DANALYA 200 MM	182,30	109	4145184580	1000V İZOLELİ ELEKTRİKÇİ YILDIZ UÇLU TORNAVIDA 4.5X80	28,55	127
3852240225	DELİK ZIMBA 225 MM	115,90	104	4145186100	1000V İZOLELİ ELEKTRİKÇİ YILDIZ UÇLU TORNAVIDA 6X100	33,60	127
3860260180	TESTERE ÇAPRAZI 180 MM	123,50	106	4150008106	ELTA OPAK SERİ TORNAVIDA SETİ 6 PARÇA	114,80	192
4100008107	KRAFT SERİ TORNAVIDA SETİ 7 PARÇA	164,40	125	4150008107	ELTA OPAK SERİ TORNAVIDA SETİ 7 PARÇA	137,35	192
4100008108	KRAFT SERİ DÜZ UÇLU TORNAVIDA SERİSİ 8 PARÇA	185,30	124	4150170380	ELTA OPAK SERİ DÜZ UÇLU TORNAVIDA 3X80	11,45	191
4100170340	KRAFT SERİ DÜZ UÇLU TORNAVIDA 3x40	15,10	124	4150170480	ELTA OPAK SERİ DÜZ UÇLU TORNAVIDA 4X80	13,20	191
4100170380	KRAFT SERİ DÜZ UÇLU TORNAVIDA 3x80	16,05	124	4150174100	ELTA OPAK SERİ DÜZ UÇLU TORNAVIDA 4X100	14,10	191
4100170480	KRAFT SERİ DÜZ UÇLU TORNAVIDA 4x80	17,35	124	4150175100	ELTA OPAK SERİ DÜZ UÇLU TORNAVIDA 5X100	17,00	191
4100170580	KRAFT SERİ DÜZ UÇLU TORNAVIDA 5x80	21,25	124	4150175125	ELTA OPAK SERİ DÜZ UÇLU TORNAVIDA 5X125	19,60	191
4100171125	KRAFT SERİ DÜZ UÇLU TORNAVIDA 11x250	71,10	124	4150176100	ELTA OPAK SERİ DÜZ UÇLU TORNAVIDA 6X100	17,65	191
4100174100	KRAFT SERİ DÜZ UÇLU TORNAVIDA 4x100	20,10	124	4150176125	ELTA OPAK SERİ DÜZ UÇLU TORNAVIDA 6X125	20,10	191
4100174250	KRAFT SERİ DÜZ UÇLU TORNAVIDA 4x250	41,90	124	4150176150	ELTA OPAK SERİ DÜZ UÇLU TORNAVIDA 6X150	22,15	191
4100174300	KRAFT SERİ DÜZ UÇLU TORNAVIDA 4x300	49,50	124	4150177125	ELTA OPAK SERİ DÜZ UÇLU TORNAVIDA 7X125	19,35	191
4100175100	KRAFT SERİ DÜZ UÇLU TORNAVIDA 5x100	23,40	124	4150177150	ELTA OPAK SERİ DÜZ UÇLU TORNAVIDA 7X150	25,95	191
4100175125	KRAFT SERİ DÜZ UÇLU TORNAVIDA 5x125	26,75	124	4150178150	ELTA OPAK SERİ DÜZ UÇLU TORNAVIDA 8X150	28,10	191
4100175150	KRAFT SERİ DÜZ UÇLU TORNAVIDA 5x150	29,15	124	4150178175	ELTA OPAK SERİ DÜZ UÇLU TORNAVIDA 8X175	31,50	191
4100175250	KRAFT SERİ DÜZ UÇLU TORNAVIDA 5x250	55,30	124	4160170380	ELTA ERGONOM SERİ DÜZ UÇLU TORNAVIDA 3X80	10,05	192
4100175300	KRAFT SERİ DÜZ UÇLU TORNAVIDA 5x300	50,05	124	4160170480	ELTA ERGONOM SERİ DÜZ UÇLU TORNAVIDA 4X80	11,35	192
4100175350	KRAFT SERİ DÜZ UÇLU TORNAVIDA 5x350	62,50	124	4160170580	ELTA ERGONOM SERİ DÜZ UÇLU TORNAVIDA 5X80	12,65	192
4100176100	KRAFT SERİ DÜZ UÇLU TORNAVIDA 6x100	24,00	124	4160174100	ELTA ERGONOM SERİ DÜZ UÇLU TORNAVIDA 4X100	12,50	192
4100176125	KRAFT SERİ DÜZ UÇLU TORNAVIDA 6x125	27,50	124	4160175100	ELTA ERGONOM SERİ DÜZ UÇLU TORNAVIDA 5X100	15,10	192
4100176150	KRAFT SERİ DÜZ UÇLU TORNAVIDA 6x150	30,15	124	4160175125	ELTA ERGONOM SERİ DÜZ UÇLU TORNAVIDA 5X125	17,45	192
4100176175	KRAFT SERİ DÜZ UÇLU TORNAVIDA 6x175	38,75	124	4160176150	ELTA ERGONOM SERİ DÜZ UÇLU TORNAVIDA 6X150	19,55	192
4100176350	KRAFT SERİ DÜZ UÇLU TORNAVIDA 6x350	66,15	124	4160177150	ELTA ERGONOM SERİ DÜZ UÇLU TORNAVIDA 7X150	23,05	192
4100177125	KRAFT SERİ DÜZ UÇLU TORNAVIDA 7x125	30,60	124	4170170680	ELTA DEĞİŞKEN UÇLU TORNAVIDA 6X80	26,40	193
4100177150	KRAFT SERİ DÜZ UÇLU TORNAVIDA 7x150	35,35	124	4170180360	ELTA OPAK SERİ YILDIZ UÇLU TORNAVIDA 3X60	12,95	191
4100177175	KRAFT SERİ DÜZ UÇLU TORNAVIDA 7x175	40,55	124	4170184580	ELTA OPAK SERİ YILDIZ UÇLU TORNAVIDA 4.5X80	17,50	191
4100178150	KRAFT SERİ DÜZ UÇLU TORNAVIDA 8x150	40,20	124	4170186100	ELTA OPAK SERİ YILDIZ UÇLU TORNAVIDA 6X100	21,05	191
				4170188150	ELTA OPAK SERİ YILDIZ UÇLU TORNAVIDA 8X150	39,80	191

KOD	ÜRÜN	FİYAT	SAYFA
4180180360	ELTA ERGONOM SERİ YILDIZ UÇLU TORNAVİDA 3X60	11,65	192
4180184510	ELTA ERGONOM SERİ YILDIZ UÇLU TORNAVİDA 4.5X100	17,05	192
4180188150	ELTA ERGONOM SERİ YILDIZ UÇLU TORNAVİDA 8X150	34,85	192
4240007102	DEĞİŞKEN UCLU TORNAVİDA TAKIMI	51,15	130
4240170680	DEĞİŞKEN UCLU TORNAVİDA 6X80	30,85	130
4300008107	OPAK SERİ TORNAVİDA SETİ 7 PARÇA	147,15	128
4300170380	OPAK SERİ DÜZ UÇLU TORNAVİDA 3x80	14,10	128
4300170480	OPAK SERİ DÜZ UÇLU TORNAVİDA 4x80	14,60	128
4300174100	OPAK SERİ DÜZ UÇLU TORNAVİDA 4X100	17,45	128
4300175100	OPAK SERİ DÜZ UÇLU TORNAVİDA 5x100	21,05	128
4300175125	OPAK SERİ DÜZ UÇLU TORNAVİDA 5x125	24,50	128
4300176100	OPAK SERİ DÜZ UÇLU TORNAVİDA 6x100	21,90	128
4300176125	OPAK SERİ DÜZ UÇLU TORNAVİDA 6x125	25,00	128
4300176150	OPAK SERİ DÜZ UÇLU TORNAVİDA 6x150	27,35	128
4300177125	OPAK SERİ DÜZ UÇLU TORNAVİDA 7x125	28,00	128
4300177150	OPAK SERİ DÜZ UÇLU TORNAVİDA 7x150	32,15	128
4300178175	OPAK SERİ DÜZ UÇLU TORNAVİDA 8x175	39,05	128
4300179200	OPAK SERİ DÜZ UÇLU TORNAVİDA 9x200	51,55	128
4320180360	OPAK SERİ YILDIZ UÇLU TORNAVİDA 3x60	15,55	128
4320184580	OPAK SERİ YILDIZ UÇLU TORNAVİDA 4.5X80	22,25	128
4320186100	OPAK SERİ YILDIZ UÇLU TORNAVİDA 6x100	26,90	128
4320188150	OPAK SERİ YILDIZ UÇLU TORNAVİDA 8x150	51,05	128
4325180360	OPAK SERİ POZİDRİV YILDIZ UÇLU TORNAVİDA 3X60	17,00	128
4325184580	OPAK SERİ POZİDRİV YILDIZ UÇLU TORNAVİDA 4.5X80	24,50	128
4325186100	OPAK SERİ POZİDRİV YILDIZ UÇLU TORNAVİDA 6X100	29,50	128
4325188150	OPAK SERİ POZİDRİV YILDIZ UÇLU TORNAVİDA 8X150	56,00	128
4350008107	ERGONOMİK SERİ TORNAVİDA SETİ 7 PARÇA	171,60	129
4350170380	ERGONOMİK SERİ DÜZ UÇLU TORNAVİDA 3x80	17,45	129
4350170480	ERGONOMİK SERİ DÜZ UÇLU TORNAVİDA 4x80	18,30	129
4350174100	ERGONOMİK SERİ DÜZ UÇLU TORNAVİDA 4x100	20,85	129
4350175100	ERGONOMİK SERİ DÜZ UÇLU TORNAVİDA 5x100	24,00	129
4350175125	ERGONOMİK SERİ DÜZ UÇLU TORNAVİDA 5x125	27,70	129
4350176100	ERGONOMİK SERİ DÜZ UÇLU TORNAVİDA 6x100	24,85	129
4350176125	ERGONOMİK SERİ DÜZ UÇLU TORNAVİDA 6x125	28,45	129
4350176150	ERGONOMİK SERİ DÜZ UÇLU TORNAVİDA 6x150	31,20	129
4350177125	ERGONOMİK SERİ DÜZ UÇLU TORNAVİDA 7x125	31,80	129
4350177150	ERGONOMİK SERİ DÜZ UÇLU TORNAVİDA 7x150	36,55	129
4350178175	ERGONOMİK SERİ DÜZ UÇLU TORNAVİDA 8x175	44,35	129
4350179200	ERGONOMİK SERİ DÜZ UÇLU TORNAVİDA 9x200	56,55	129
4370180360	ERGONOMİK SERİ YILDIZ UÇLU TORNAVİDA 3x60	17,75	129
4370184580	ERGONOMİK SERİ YILDIZ UÇLU TORNAVİDA 4.5x80	25,35	129
4370185100	ERGONOMİK SERİ YILDIZ UÇLU TORNAVİDA 4.5x100	24,25	129
4370185150	ERGONOMİK SERİ YILDIZ UÇLU TORNAVİDA 4.5x150	27,50	129
4370186100	ERGONOMİK SERİ YILDIZ UÇLU TORNAVİDA 6x100	30,75	129
4370186150	ERGONOMİK SERİ YILDIZ UÇLU TORNAVİDA 6x150	32,20	129
4370188150	ERGONOMİK SERİ YILDIZ UÇLU TORNAVİDA 8x150	57,90	129
4500008106	ELEKTRONİKÇİ TİP KLEMENS TORNAVİDA SETİ 6 PARÇA	125,40	130
4500170380	ELEKTRONİKÇİ TİP KLEMENS DÜZ UÇLU TORNAVİDA 3X80	15,20	130
4500170480	ELEKTRONİKÇİ TİP KLEMENS DÜZ UÇLU TORNAVİDA 4X80	15,60	130
4500172560	ELEKTRONİKÇİ TİP KLEMENS DÜZ UÇLU TORNAVİDA 2.5X60	13,70	130
4500172580	ELEKTRONİKÇİ TİP KLEMENS DÜZ UÇLU TORNAVİDA 2.5X80	14,35	130
4500173100	ELEKTRONİKÇİ TİP KLEMENS DÜZ UÇLU TORNAVİDA 3X100	18,55	130
4500173125	ELEKTRONİKÇİ TİP KLEMENS DÜZ UÇLU TORNAVİDA 3X125	24,50	130
4500173510	ELEKTRONİKÇİ TİP KLEMENS DÜZ UÇLU TORNAVİDA 3.5X100	19,15	130
4500174100	ELEKTRONİKÇİ TİP KLEMENS DÜZ UÇLU TORNAVİDA 4X100	19,15	130
4500174125	ELEKTRONİKÇİ TİP KLEMENS DÜZ UÇLU TORNAVİDA 4X125	25,75	130
4500174150	ELEKTRONİKÇİ TİP KLEMENS DÜZ UÇLU TORNAVİDA 4X150	28,05	130
4501173150	ELTA ELEKTRONİKÇİ TİP KLEMENS DÜZ UÇLU TORNAVİDA 3X150	15,10	193
4501174150	ELTA ELEKTRONİKÇİ TİP KLEMENS DÜZ UÇLU TORNAVİDA 4X150	16,05	193
4520180360	ELEKTRONİKÇİ TİP KLEMENS YILDIZ UÇLU TORNAVİDA 3X60	16,05	130
4520180480	ELEKTRONİKÇİ TİP KLEMENS YILDIZ UÇLU TORNAVİDA 4X80	23,05	130
4520184150	ELEKTRONİKÇİ TİP KLEMENS YILDIZ UÇLU TORNAVİDA 4X150	30,80	130
4530001006	ELEKTRONİKÇİ TİP KLEMENS TORX UÇLU TORNAVİDA TAKIMI 6 PARÇA	113,90	131
4530170560	ELEKTRONİKÇİ TİP KLEMENS TORX UÇLU TORNAVİDA T5X60	18,55	131
4530170660	ELEKTRONİKÇİ TİP KLEMENS TORX UÇLU TORNAVİDA T6X60	18,55	131
4530170760	ELEKTRONİKÇİ TİP KLEMENS TORX UÇLU TORNAVİDA T7X60	19,20	131
4530170860	ELEKTRONİKÇİ TİP KLEMENS TORX UÇLU TORNAVİDA T8X60	19,20	131

KOD	ÜRÜN	FİYAT	SAYFA
4530170960	ELEKTRONİKÇİ TİP KLEMENS TORX UÇLU TORNAVİDA T9X60	19,20	131
4530171060	ELEKTRONİKÇİ TİP KLEMENS TORX UÇLU TORNAVİDA T10X60	19,20	131
4540190190	KLİPİS SÖKME TORNAVİDASI	57,20	131
4550170135	ELEKTRİK KONTROL KALEMİ DÜZ UÇLU 135 MM	17,80	123
4550170190	ELEKTRİK KONTROL KALEMİ DÜZ UÇLU 190 MM	22,45	123
4552170190	ELTA ELEKTRİK KONTROL KALEMİ 190 MM	17,05	193
4555170165	MASTER KONTROL KALEMİ DÜZ UÇLU 165 MM	24,55	123
4560180135	ELEKTRİK KONTROL KALEMİ YILDIZ UÇLU 135 MM	19,45	123
4560180190	ELEKTRİK KONTROL KALEMİ YILDIZ UÇLU 190 MM	27,00	123
4565170135	OTO KONTROL KALEMİ 135 MM	48,00	123
4765190040	T TİPİ LOKMA UÇLU TORNAVİDA 4 MM	36,60	132
4765190050	T TİPİ LOKMA UÇLU TORNAVİDA 5 MM	36,60	132
4765190055	T TİPİ LOKMA UÇLU TORNAVİDA 5.5 MM	36,60	132
4765190060	T TİPİ LOKMA UÇLU TORNAVİDA 6 MM	36,60	132
4765190070	T TİPİ LOKMA UÇLU TORNAVİDA 7 MM	39,05	132
4765190080	T TİPİ LOKMA UÇLU TORNAVİDA 8 MM	39,05	132
4765190090	T TİPİ LOKMA UÇLU TORNAVİDA 9 MM	43,30	132
4765190100	T TİPİ LOKMA UÇLU TORNAVİDA 10 MM	43,30	132
4765190110	T TİPİ LOKMA UÇLU TORNAVİDA 11 MM	47,90	132
4765190120	T TİPİ LOKMA UÇLU TORNAVİDA 12 MM	49,45	132
4765190130	T TİPİ LOKMA UÇLU TORNAVİDA 13 MM	51,70	132
4765190140	T TİPİ LOKMA UÇLU TORNAVİDA 14 MM	60,15	132
4770008108	LOKMA UÇLU TORNAVİDA SETİ 8 PARÇA	419,65	132
4770190040	LOKMA UÇLU TORNAVİDA 4 MM	43,95	132
4770190050	LOKMA UÇLU TORNAVİDA 5 MM	43,95	132
4770190055	LOKMA UÇLU TORNAVİDA 5.5 MM	43,95	132
4770190060	LOKMA UÇLU TORNAVİDA 6 MM	43,95	132
4770190070	LOKMA UÇLU TORNAVİDA 7 MM	47,20	132
4770190080	LOKMA UÇLU TORNAVİDA 8 MM	47,20	132
4770190090	LOKMA UÇLU TORNAVİDA 9 MM	50,90	132
4770190100	LOKMA UÇLU TORNAVİDA 10 MM	50,90	132
4770190110	LOKMA UÇLU TORNAVİDA 11 MM	55,60	132
4770190120	LOKMA UÇLU TORNAVİDA 12 MM	59,65	132
4770190130	LOKMA UÇLU TORNAVİDA 13 MM	64,25	132
4770190140	LOKMA UÇLU TORNAVİDA 14 MM	71,05	132
4771190090	ELTA LOKMA UÇLU TORNAVİDA 9 MM	31,40	193
4771190110	ELTA LOKMA UÇLU TORNAVİDA 11 MM	34,65	193
4772190040	SÜNGÜSÜ İZOLELİ LOKMA UÇLU TORNAVİDA 4 MM	54,30	132
4772190050	SÜNGÜSÜ İZOLELİ LOKMA UÇLU TORNAVİDA 5 MM	54,30	132
4772190060	SÜNGÜSÜ İZOLELİ LOKMA UÇLU TORNAVİDA 6 MM	54,30	132
4772190070	SÜNGÜSÜ İZOLELİ LOKMA UÇLU TORNAVİDA 7 MM	58,30	132
4772190080	SÜNGÜSÜ İZOLELİ LOKMA UÇLU TORNAVİDA 8 MM	58,30	132
4772190090	SÜNGÜSÜ İZOLELİ LOKMA UÇLU TORNAVİDA 9 MM	62,95	132
4772190100	SÜNGÜSÜ İZOLELİ LOKMA UÇLU TORNAVİDA 10 MM	62,95	132
4772190110	SÜNGÜSÜ İZOLELİ LOKMA UÇLU TORNAVİDA 11 MM	68,75	132
4772190120	SÜNGÜSÜ İZOLELİ LOKMA UÇLU TORNAVİDA 12 MM	73,90	132
4772190130	SÜNGÜSÜ İZOLELİ LOKMA UÇLU TORNAVİDA 13 MM	75,00	132
4772190140	SÜNGÜSÜ İZOLELİ LOKMA UÇLU TORNAVİDA 14 MM	87,90	132
4773008108	1000V SÜNGÜSÜ İZOLELİ LOKMA UÇLU TORNAVİDA SETİ 8 PARÇA	594,90	133
4773190040	1000V SÜNGÜSÜ İZOLELİ LOKMA UÇLU TORNAVİDA 4 MM	62,35	133
4773190050	1000V SÜNGÜSÜ İZOLELİ LOKMA UÇLU TORNAVİDA 5 MM	62,35	133
4773190055	1000V SÜNGÜSÜ İZOLELİ LOKMA UÇLU TORNAVİDA 5.5 MM	62,35	133
4773190060	1000V SÜNGÜSÜ İZOLELİ LOKMA UÇLU TORNAVİDA 6MM	62,35	133
4773190070	1000V SÜNGÜSÜ İZOLELİ LOKMA UÇLU TORNAVİDA 7MM	66,85	133
4773190080	1000V SÜNGÜSÜ İZOLELİ LOKMA UÇLU TORNAVİDA 8MM	66,85	133
4773190090	1000V SÜNGÜSÜ İZOLELİ LOKMA UÇLU TORNAVİDA 9MM	72,20	133
4773190100	1000V SÜNGÜSÜ İZOLELİ LOKMA UÇLU TORNAVİDA 10MM	72,20	133
4773190110	1000V SÜNGÜSÜ İZOLELİ LOKMA UÇLU TORNAVİDA 11MM	78,80	133
4773190120	1000V SÜNGÜSÜ İZOLELİ LOKMA UÇLU TORNAVİDA 12MM	84,55	133
4773190130	1000V SÜNGÜSÜ İZOLELİ LOKMA UÇLU TORNAVİDA 13MM	91,10	133
4773190140	1000V SÜNGÜSÜ İZOLELİ LOKMA UÇLU TORNAVİDA 14 MM	100,75	133
4775008107	TORX UÇLU TORNAVİDA SETİ 7 PARÇA	218,80	133
4775180010	TORX UÇLU TORNAVİDA T 10 MM	23,80	133
4775180015	TORX UÇLU TORNAVİDA T 15 MM	23,80	133
4775180020	TORX UÇLU TORNAVİDA T 20 MM	26,40	133
4775180025	TORX UÇLU TORNAVİDA T 25 MM	30,60	133
4775180027	TORX UÇLU TORNAVİDA T 27 MM	33,80	133

KOD	ÜRÜN	FİYAT	SAYFA	KOD	ÜRÜN	FİYAT	SAYFA
4775180030	TORX UCLU TORNAVIDA T 30 MM	35,85	133	4830210025	TORX BİTS UÇ T 25 (25 MM)	5,45	137
4775180040	TORX UCLU TORNAVIDA T 40 MM	44,55	133	4830210027	TORX BİTS UÇ T 27 (25 MM)	5,45	137
4775180045	TORX UCLU TORNAVIDA T 45 MM	50,35	133	4830210030	TORX BİTS UÇ T 30 (25 MM)	5,45	137
4776008107	DELİKLİ TORX UÇLU TORNAVIDA SETİ 7 PARÇA	273,45	134	4830210040	TORX BİTS UÇ T 40 (25 MM)	5,45	137
4776180009	DELİKLİ TORX UÇLU TORNAVIDA TR 09	28,75	134	4830210125	TORX BİTS UÇ T 25 (50 MM)	6,85	137
4776180010	DELİKLİ TORX UÇLU TORNAVIDA TR 10	29,70	134	4830210127	TORX BİTS UÇ T 27 (50 MM)	6,85	137
4776180015	DELİKLİ TORX UÇLU TORNAVIDA TR 15	29,70	134	4830210130	TORX BİTS UÇ T 30 (50 MM)	6,85	137
4776180020	DELİKLİ TORX UÇLU TORNAVIDA TR 20	33,15	134	4830210140	TORX BİTS UÇ T 40 (50 MM)	6,85	137
4776180025	DELİKLİ TORX UÇLU TORNAVIDA TR 25	38,25	134	4831210025	ELTA TORX BİTS UÇ T25 (25 MM)	2,50	193
4776180027	DELİKLİ TORX UÇLU TORNAVIDA TR 27	42,20	134	4831210027	ELTA TORX BİTS UÇ T27 (25 MM)	2,50	193
4776180030	DELİKLİ TORX UÇLU TORNAVIDA TR 30	44,85	134	4831210030	ELTA TORX BİTS UÇ T30 (25 MM)	2,50	193
4776180040	DELİKLİ TORX UÇLU TORNAVIDA TR 40	55,60	134	4831210040	ELTA TORX BİTS UÇ T40 (25 MM)	2,50	193
4780196120	MANYETİK BİTS TUTUCU TORNAVIDA UZUN 6.3X120	53,85	134	4831210125	ELTA TORX BİTS UÇ T25 (50 MM)	4,20	193
4783196120	1000V SÜNGÜSÜ İZOLELİ MANYETİK BİTS TUTUCU TORNAVIDA 6.3x120	70,10	134	4831210127	ELTA TORX BİTS UÇ T27 (50 MM)	4,20	193
4784196346	1/4" AVUÇ İÇİ BİTS TUTUCU	109,30	138	4831210140	ELTA TORX BİTS UÇ T40 (50 MM)	4,20	193
4785196330	MANYETİK BİTS TUTUCU TORNAVIDA KISA 6.3X30	30,85	134	4850000713	UZUN BİTS UÇ TAKIM 13 PARÇA (75 MM)	109,55	138
4788196160	MANYETİK BİTS TUTUCU TORNAVIDA FLEXIBLEE 6.3X170	117,60	135	4850001013	UZUN BİTS UÇ TAKIM 13 PARÇA (100 MM)	163,50	138
4790266360	ÜNİVERSAL BİTS ADAPTÖRÜ MANYETİK 6.3X60	23,65	134	4850001513	UZUN BİTS UÇ TAKIM 13 PARÇA (150 MM)	234,05	138
4795190010	T TİPİ MANYETİK BİTS TUTUCU TORNAVIDA 6.3X130	52,45	135	4860200745	DÜZ BİTS UÇ 0.6X4.5 (75 MM)	8,10	136
4800008106	6'LI BİTS SET (25 MM)	23,10	135	4860200755	DÜZ BİTS UÇ 0.8X5.5 (75 MM)	8,10	136
4800008110	10'LU BİTS SET (25 MM)	42,80	135	4860200765	DÜZ BİTS UÇ 1.2X6.5 (75 MM)	8,10	136
4800008131	31'LI BİTS TAKIM (PLASTİK KUTULU)	139,15	135	4860201045	DÜZ BİTS UÇ 0.6X4.5 (100 MM)	12,10	136
4805205010	1/4" M-1/4" M BİTS UÇ LOKMA ADAPTÖRÜ 50MM (MAKİNA KULLANIMINA UYGUN)	9,70	135	4860201055	DÜZ BİTS UÇ 0.8X5.5 (100 MM)	12,10	136
4805205011	1/4" M-1/2" M BİTS UÇ LOKMA ADAPTÖRÜ 50MM (MAKİNA KULLANIMINA UYGUN)	19,75	135	4860201065	DÜZ BİTS UÇ 1.2X6.5 (100 MM)	12,10	136
4810000645	DÜZ BİTS UÇ SET 0.6X4.5 (25 MM)	33,50	136	4860201545	DÜZ BİTS UÇ 0.6X4.5 (150 MM)	17,35	136
4810000855	DÜZ BİTS UÇ SET 0.8X5.5 (25 MM)	33,50	136	4860201555	DÜZ BİTS UÇ 0.8X5.5 (150 MM)	17,35	136
4810001265	DÜZ BİTS UÇ SET 1.2X6.5 (25 MM)	33,50	136	4860201565	DÜZ BİTS UÇ 1.2X6.5 (150 MM)	17,35	136
4810200645	DÜZ BİTS UÇ 0.6X4.5 (25 MM)	3,35	136	4870210701	YILDIZ BİTS UÇ PH 1 (75 MM)	8,20	136
4810200855	DÜZ BİTS UÇ 0.8X5.5 (25 MM)	3,35	136	4870210702	YILDIZ BİTS UÇ PH 2 (75 MM)	8,20	136
4810201265	DÜZ BİTS UÇ 1.2X6.5 (25 MM)	3,35	136	4870210703	YILDIZ BİTS UÇ PH 3 (75 MM)	8,20	136
4810205265	DÜZ BİTS UÇ 1.2X6.5 (50MM)	5,30	136	4870211001	YILDIZ BİTS UÇ PH 1 (100 MM)	12,55	136
4810205645	DÜZ BİTS UÇ 0.6X4.5 (50MM)	5,30	136	4870211002	YILDIZ BİTS UÇ PH 2 (100 MM)	12,55	136
4810205855	DÜZ BİTS UÇ 0.8X5.5 (50MM)	5,30	136	4870211003	YILDIZ BİTS UÇ PH 3 (100 MM)	12,55	136
4811200645	ELTA DÜZ BİTS UÇ 0.6X4.5 (25MM)	2,00	193	4870211501	YILDIZ BİTS UÇ PH 1 (150 MM)	17,80	136
4811200855	ELTA DÜZ BİTS UÇ 0.8X5.5 (25 MM)	2,00	193	4870211502	YILDIZ BİTS UÇ PH 2 (150 MM)	17,80	136
4811201265	ELTA DÜZ BİTS UÇ 1.2X6.5 (25 MM)	2,00	193	4870211503	YILDIZ BİTS UÇ PH 3 (150 MM)	17,80	136
4811205265	ELTA DÜZ BİTS UÇ 1.2X6.5 (50 MM)	3,05	193	4880210701	POZİDRİV BİTS UÇ Pz 1 (75 MM)	8,35	137
4811205645	ELTA DÜZ BİTS UÇ 0.6X4.5 (50 MM)	3,05	193	4880210702	POZİDRİV BİTS UÇ Pz 2 (75 MM)	8,35	137
4811205855	ELTA DÜZ BİTS UÇ 0.8X5.5 (50 MM)	3,05	193	4880210703	POZİDRİV BİTS UÇ Pz 3 (75 MM)	8,35	137
4815006107	DEĞİŞKEN BİTS UÇLU TORNAVIDA SET (7 Parça)	65,25	135	4880211001	POZİDRİV BİTS UÇ Pz 1 (100 MM)	12,65	137
4820000001	YILDIZ BİTS UÇ SET PH 1 (25 MM)	36,50	136	4880211002	POZİDRİV BİTS UÇ Pz 2 (100 MM)	12,65	137
4820000002	YILDIZ BİTS UÇ SET PH 2 (25 MM)	36,50	136	4880211003	POZİDRİV BİTS UÇ Pz 3 (100 MM)	12,65	137
4820000003	YILDIZ BİTS UÇ SET PH 3 (25 MM)	36,50	136	4880211501	POZİDRİV BİTS UÇ Pz 1 (150 MM)	18,20	137
4820210001	YILDIZ BİTS UÇ PH 1 (25 MM)	3,65	136	4880211502	POZİDRİV BİTS UÇ Pz 2 (150 MM)	18,20	137
4820210002	YILDIZ BİTS UÇ PH 2 (25 MM)	3,65	136	4880211503	POZİDRİV BİTS UÇ Pz 3 (150 MM)	18,20	137
4820210003	YILDIZ BİTS UÇ PH 3 (25 MM)	3,65	136	4885210725	TORX BİTS UÇ T 25 (75 MM)	8,90	137
4820210011	YILDIZ BİTS UÇ PH 1 (50 MM)	5,45	136	4885210727	TORX BİTS UÇ T 27 (75 MM)	8,90	137
4820210012	YILDIZ BİTS UÇ PH 2 (50 MM)	5,45	136	4885210730	TORX BİTS UÇ T 30 (75 MM)	8,90	137
4820210013	YILDIZ BİTS UÇ PH 3 (50 MM)	5,45	136	4885210740	TORX BİTS UÇ T 40 (75 MM)	8,90	137
4821210001	ELTA YILDIZ BİTS UÇ PH1 (25 MM)	1,80	193	4885211025	TORX BİTS UÇ T 25 (100 MM)	12,90	137
4821210002	ELTA YILDIZ BİTS UÇ PH2 (25MM)	1,80	193	4885211027	TORX BİTS UÇ T 27 (100 MM)	12,90	137
4821210003	ELTA YILDIZ BİTS UÇ PH3 (25 MM)	1,80	193	4885211030	TORX BİTS UÇ T 30 (100 MM)	12,90	137
4821210011	ELTA YILDIZ BİTS UÇ PH1 (50 MM)	3,70	193	4885211040	TORX BİTS UÇ T 40 (100 MM)	12,90	137
4821210013	ELTA YILDIZ BİTS UÇ PH3 (50 MM)	3,70	193	4885211525	TORX BİTS UÇ T 25 (150 MM)	18,50	137
4825000001	POZİDRİV BİTS SET Pz 1 (25 MM)	39,50	137	4885211527	TORX BİTS UÇ T 27 (150 MM)	18,50	137
4825000002	POZİDRİV BİTS SET Pz 2 (25 MM)	39,50	137	4885211530	TORX BİTS UÇ T 30 (150 MM)	18,50	137
4825000003	POZİDRİV BİTS SET Pz 3 (25 MM)	39,50	137	4885211540	TORX BİTS UÇ T 40 (150 MM)	18,50	137
4825210001	POZİDRİV BİTS UÇ Pz 1 (25 MM)	3,95	137	4900003110	ALLEN ANAHTAR TAKIMI 10 PARÇA	69,05	139
4825210002	POZİDRİV BİTS UÇ Pz 2 (25 MM)	3,95	137	4900003112	ALLEN ANAHTAR TAKIMI 12 PARÇA	91,90	139
4825210003	POZİDRİV BİTS UÇ Pz 3 (25 MM)	3,95	137	4900220015	ALLEN ANAHTAR ALTI KÖŞE 1.5 MM	2,00	139
4825210011	POZİDRİV BİTS UÇ PZ 1 (50 MM)	5,75	137	4900220025	ALLEN ANAHTAR ALTI KÖŞE 2 MM	2,35	139
4825210012	POZİDRİV BİTS UÇ PZ 2 (50 MM)	5,75	137	4900220025	ALLEN ANAHTAR ALTI KÖŞE 2.5 MM	2,90	139
4825210013	POZİDRİV BİTS UÇ PZ 3 (50 MM)	5,75	137	4900220030	ALLEN ANAHTAR ALTI KÖŞE 3 MM	3,20	139
4830000025	TORX BİTS UÇ SET T 25 (25 MM)	54,50	137	4900220035	ALLEN ANAHTAR ALTI KÖŞE 3.5 MM	3,95	139
4830000027	TORX BİTS UÇ SET T 27 (25 MM)	54,50	137	4900220040	ALLEN ANAHTAR ALTI KÖŞE 4 MM	4,05	139
4830000030	TORX BİTS UÇ SET T 30 (25 MM)	54,50	137	4900220050	ALLEN ANAHTAR ALTI KÖŞE 5 MM	4,70	139
4830000040	TORX BİTS UÇ SET T 40 (25 MM)	54,50	137	4900220060	ALLEN ANAHTAR ALTI KÖŞE 6 MM	6,25	139

KOD	ÜRÜN	FİYAT	SAYFA
4900220070	ALLEN ANAHTAR ALTI KÖŞE 7 MM	9,20	139
4900220080	ALLEN ANAHTAR ALTI KÖŞE 8 MM	9,70	139
4900220090	ALLEN ANAHTAR ALTI KÖŞE 9 MM	11,95	139
4900220100	ALLEN ANAHTAR ALTI KÖŞE 10 MM	14,75	139
4900220120	ALLEN ANAHTAR ALTI KÖŞE 12 MM	18,90	139
4900220140	ALLEN ANAHTAR ALTI KÖŞE 14 MM	32,30	139
4900220160	ALLEN ANAHTAR ALTI KÖŞE 16 MM	59,70	139
4900220170	ALLEN ANAHTAR ALTI KÖŞE 17 MM	64,35	139
4900220190	ALLEN ANAHTAR ALTI KÖŞE 19 MM	79,60	139
4900220220	ALLEN ANAHTAR ALTI KÖŞE 22 MM	124,05	139
4900220240	ALLEN ANAHTAR ALTI KÖŞE 24 MM	167,45	139
4901003110	ALLEN ANAHTAR TAKIMI ALTI KÖŞE SAE 10 PARÇA	100,20	139
4901003112	ALLEN ANAHTAR TAKIMI ALTI KÖŞE SAE 12 PARÇA	175,40	139
4901221111	ALLEN ANAHTAR ALTI KÖŞE 7/16 SAE	24,25	139
4901221270	ALLEN ANAHTAR ALTI KÖŞE 1/2 SAE	30,60	139
4901221428	ALLEN ANAHTAR ALTI KÖŞE 9/16 SAE	44,60	139
4901221587	ALLEN ANAHTAR ALTI KÖŞE 5/8 SAE	69,35	139
4901221905	ALLEN ANAHTAR ALTI KÖŞE 3/4 SAE	97,10	139
4901221984	ALLEN ANAHTAR ALTI KÖŞE 5/64 SAE	3,85	139
4901222381	ALLEN ANAHTAR ALTI KÖŞE 3/32 SAE	4,20	139
4901223125	ALLEN ANAHTAR ALTI KÖŞE 1/8 SAE	5,10	139
4901223968	ALLEN ANAHTAR ALTI KÖŞE 5/32 SAE	6,25	139
4901224762	ALLEN ANAHTAR ALTI KÖŞE 3/16 SAE	6,40	139
4901225556	ALLEN ANAHTAR ALTI KÖŞE 7/32 SAE	8,60	139
4901226350	ALLEN ANAHTAR ALTI KÖŞE 1/4 SAE	10,50	139
4901227937	ALLEN ANAHTAR ALTI KÖŞE 5/16 SAE	13,05	139
4901229825	ALLEN ANAHTAR ALTI KÖŞE 3/8 SAE	18,00	139
4903003110	ALLEN ANAHTAR TAKIMI ALTI KÖŞE UZUN BOY 10 PARÇA	130,45	140
4903003112	ALLEN ANAHTAR TAKIMI ALTI KÖŞE UZUN BOY 12 PARÇA	173,95	140
4903220020	ALLEN ANAHTAR ALTI KÖŞE UZUN BOY 2 MM	4,20	140
4903220025	ALLEN ANAHTAR ALTI KÖŞE UZUN BOY 2.5 MM	4,95	140
4903220030	ALLEN ANAHTAR ALTI KÖŞE UZUN BOY 3 MM	5,65	140
4903220035	ALLEN ANAHTAR ALTI KÖŞE UZUN BOY 3.5 MM	6,95	140
4903220040	ALLEN ANAHTAR ALTI KÖŞE UZUN BOY 4 MM	7,10	140
4903220050	ALLEN ANAHTAR ALTI KÖŞE UZUN BOY 5 MM	7,45	140
4903220060	ALLEN ANAHTAR ALTI KÖŞE UZUN BOY 6 MM	12,10	140
4903220070	ALLEN ANAHTAR ALTI KÖŞE UZUN BOY 7 MM	18,00	140
4903220080	ALLEN ANAHTAR ALTI KÖŞE UZUN BOY 8 MM	18,90	140
4903220090	ALLEN ANAHTAR ALTI KÖŞE UZUN BOY 9 MM	23,25	140
4903220100	ALLEN ANAHTAR ALTI KÖŞE UZUN BOY 10 MM	28,85	140
4903220120	ALLEN ANAHTAR ALTI KÖŞE UZUN BOY 12 MM	36,55	140
4903220140	ALLEN ANAHTAR ALTI KÖŞE UZUN BOY 14 MM	63,05	140
4903220160	ALLEN ANAHTAR ALTI KÖŞE UZUN BOY 16 MM	102,05	140
4903220170	ALLEN ANAHTAR ALTI KÖŞE UZUN BOY 17 MM	111,15	140
4903220190	ALLEN ANAHTAR ALTI KÖŞE UZUN BOY 19 MM	164,70	140
4905007108	YUVARLAK BAŞLI ALLEN ANAHTAR TAKIMI 8 PARÇA	96,30	140
4905220020	YUVARLAK BAŞLI ALLEN ANAHTAR 2 MM	4,75	140
4905220025	YUVARLAK BAŞLI ALLEN ANAHTAR 2.5 MM	5,70	140
4905220030	YUVARLAK BAŞLI ALLEN ANAHTAR 3 MM	6,50	140
4905220040	YUVARLAK BAŞLI ALLEN ANAHTAR 4 MM	8,10	140
4905220050	YUVARLAK BAŞLI ALLEN ANAHTAR 5 MM	8,50	140
4905220060	YUVARLAK BAŞLI ALLEN ANAHTAR 6 MM	12,80	140
4905220080	YUVARLAK BAŞLI ALLEN ANAHTAR 8 MM	19,70	140
4905220100	YUVARLAK BAŞLI ALLEN ANAHTAR 10 MM	30,25	140
4906003109	YUVARLAK BAŞLI ALLEN ANAHTAR TAKIMI ALTI KÖŞE UZUN BOY 9 PARÇA	134,85	141
4906220015	YUVARLAK BAŞLI ALLEN ANAHTAR UZUN BOY 1.5 MM	6,30	141
4906220020	YUVARLAK BAŞLI ALLEN ANAHTAR UZUN BOY 2 MM	8,45	141
4906220025	YUVARLAK BAŞLI ALLEN ANAHTAR UZUN BOY 2.5 MM	9,15	141
4906220030	YUVARLAK BAŞLI ALLEN ANAHTAR UZUN BOY 3 MM	9,95	141
4906220040	YUVARLAK BAŞLI ALLEN ANAHTAR UZUN BOY 4 MM	11,30	141
4906220050	YUVARLAK BAŞLI ALLEN ANAHTAR UZUN BOY 5 MM	14,25	141
4906220060	YUVARLAK BAŞLI ALLEN ANAHTAR UZUN BOY 6 MM	16,35	141
4906220080	YUVARLAK BAŞLI ALLEN ANAHTAR UZUN BOY 8 MM	24,25	141
4906220100	YUVARLAK BAŞLI ALLEN ANAHTAR UZUN BOY 10 MM	34,85	141
4908003107	ELTA ALLEN ANAHTAR TAKIMI ALTI KÖŞE 7 PARÇA	21,10	194
4908003109	ELTA ALLEN ANAHTAR TAKIMI ALTI KÖŞE 9 PARÇA	41,00	194

KOD	ÜRÜN	FİYAT	SAYFA
4908003110	ELTA ALLEN ANAHTAR TAKIMI ALTI KÖŞE 10 PARÇA	58,55	194
4908220015	ELTA ALLEN ANAHTAR ALTI KÖŞE 1.5 MM	1,65	194
4908220020	ELTA ALLEN ANAHTAR ALTI KÖŞE 2 MM	2,05	194
4908220025	ELTA ALLEN ANAHTAR ALTI KÖŞE 2.5 MM	2,50	194
4908220030	ELTA ALLEN ANAHTAR ALTI KÖŞE 3 MM	2,85	194
4908220035	ELTA ALLEN ANAHTAR ALTI KÖŞE 3.5 MM	3,05	194
4908220040	ELTA ALLEN ANAHTAR ALTI KÖŞE 4 MM	3,55	194
4908220050	ELTA ALLEN ANAHTAR ALTI KÖŞE 5 MM	3,70	194
4908220060	ELTA ALLEN ANAHTAR ALTI KÖŞE 6 MM	4,80	194
4908220070	ELTA ALLEN ANAHTAR ALTI KÖŞE 7 MM	6,80	194
4908220080	ELTA ALLEN ANAHTAR ALTI KÖŞE 8 MM	7,90	194
4908220090	ELTA ALLEN ANAHTAR ALTI KÖŞE 9 MM	11,15	194
4908220100	ELTA ALLEN ANAHTAR ALTI KÖŞE 10 MM	12,00	194
4908220120	ELTA ALLEN ANAHTAR ALTI KÖŞE 12 MM	17,55	194
4908220140	ELTA ALLEN ANAHTAR ALTI KÖŞE 14 MM	26,30	194
4908220170	ELTA ALLEN ANAHTAR ALTI KÖŞE 17 MM	46,25	194
4908220190	ELTA ALLEN ANAHTAR ALTI KÖŞE 19 MM	60,35	194
4909008108	T TİPİ TORX ALLEN ANAHTAR TAKIMI 8 PARÇA	368,30	142
4909220009	T TİPİ TORX ALLEN ANAHTAR T 9	41,50	142
4909220010	T TİPİ TORX ALLEN ANAHTAR T 10	42,30	142
4909220015	T TİPİ TORX ALLEN ANAHTAR T 15	43,20	142
4909220020	T TİPİ TORX ALLEN ANAHTAR T 20	43,55	142
4909220025	T TİPİ TORX ALLEN ANAHTAR T 25	44,55	142
4909220027	T TİPİ TORX ALLEN ANAHTAR T 27	49,50	142
4909220030	T TİPİ TORX ALLEN ANAHTAR T 30	50,90	142
4909220040	T TİPİ TORX ALLEN ANAHTAR T 40	52,80	142
4910007108	TORX ALLEN ANAHTAR TAKIMI 8 PARÇA	150,90	141
4910220006	TORX ALLEN ANAHTAR T 6	17,35	141
4910220007	TORX ALLEN ANAHTAR T 7	17,35	141
4910220008	TORX ALLEN ANAHTAR T 8	17,35	141
4910220009	TORX ALLEN ANAHTAR T 9	17,45	141
4910220010	TORX ALLEN ANAHTAR T 10	17,45	141
4910220015	TORX ALLEN ANAHTAR T 15	18,00	141
4910220020	TORX ALLEN ANAHTAR T 20	18,80	141
4910220025	TORX ALLEN ANAHTAR T 25	18,80	141
4910220027	TORX ALLEN ANAHTAR T 27	18,80	141
4910220030	TORX ALLEN ANAHTAR T 30	20,15	141
4910220040	TORX ALLEN ANAHTAR T 40	21,45	141
4910220045	TORX ALLEN ANAHTAR T 45	26,30	141
4910220050	TORX ALLEN ANAHTAR T 50	30,00	141
4910220055	TORX ALLEN ANAHTAR T 55	41,60	141
4910220060	TORX ALLEN ANAHTAR T 60	57,35	141
4911220006	ELTA TORX ALLEN ANAHTAR T 6	8,90	194
4911220007	ELTA TORX ALLEN ANAHTAR T 7	8,90	194
4911220008	ELTA TORX ALLEN ANAHTAR T 8	8,90	194
4911220009	ELTA TORX ALLEN ANAHTAR T 9	9,80	194
4911220015	ELTA TORX ALLEN ANAHTAR T 15	10,10	194
4911220020	ELTA TORX ALLEN ANAHTAR T 20	10,55	194
4911220025	ELTA TORX ALLEN ANAHTAR T 25	10,55	194
4911220027	ELTA TORX ALLEN ANAHTAR T 27	10,55	194
4911220030	ELTA TORX ALLEN ANAHTAR T 30	11,35	194
4911220040	ELTA TORX ALLEN ANAHTAR T 40	12,00	194
4911220045	ELTA TORX ALLEN ANAHTAR T 45	14,75	194
4911220050	ELTA TORX ALLEN ANAHTAR T 50	16,80	194
4911220055	ELTA TORX ALLEN ANAHTAR T 55	23,40	194
4911220060	ELTA TORX ALLEN ANAHTAR T 60	32,30	194
4912000007	KASET ALLEN ANAHTAR TAKIMI 7 PARÇA (1,5MM-6MM)	91,00	142
4912003107	KASET ALLEN ANAHTAR TAKIMI 7 PARÇA (2,5MM-10MM)	135,15	142
4915006106	ELTA KASET ALLEN ANAHTAR TAKIMI 6 PARÇA MM	91,00	194
4920008108	T TİPİ ALLEN ANAHTAR TAKIMI 8 PARÇA	293,95	143
4920220025	T TİPİ ALLEN ANAHTAR 2.5 MM	25,60	143
4920220030	T TİPİ ALLEN ANAHTAR 3 MM	26,10	143
4920220040	T TİPİ ALLEN ANAHTAR 4 MM	29,25	143
4920220050	T TİPİ ALLEN ANAHTAR 5 MM	31,25	143
4920220060	T TİPİ ALLEN ANAHTAR 6 MM	35,70	143
4920220070	T TİPİ ALLEN ANAHTAR 7 MM	37,50	143
4920220080	T TİPİ ALLEN ANAHTAR 8 MM	41,85	143

KOD	ÜRÜN	FİYAT	SAYFA	KOD	ÜRÜN	FİYAT	SAYFA
4920220100	T TİPİ ALLEN ANAHTAR 10 MM	66,70	143	5540244120	NOKTA ZIMBA 4X120	31,65	148
4921008108	T TİPİ YUVARLAK BAŞLI ALLEN ANAHTAR TAKIMI 8 PARÇA	379,10	143	5540245120	NOKTA ZIMBA 5x120	37,25	148
4921220025	T TİPİ YUVARLAK BAŞLI ALLEN ANAHTAR 2.5 MM	33,25	143	5540245150	NOKTA ZIMBA 5X150	41,25	148
4921220030	T TİPİ YUVARLAK BAŞLI ALLEN ANAHTAR 3 MM	33,65	143	5545240002	KONİK PİM ZIMBA 2 MM	28,20	148
4921220040	T TİPİ YUVARLAK BAŞLI ALLEN ANAHTAR 4 MM	37,80	143	5545240003	KONİK PİM ZIMBA 3 MM	30,70	148
4921220050	T TİPİ YUVARLAK BAŞLI ALLEN ANAHTAR 5 MM	40,55	143	5545240004	KONİK PİM ZIMBA 4 MM	34,55	148
4921220060	T TİPİ YUVARLAK BAŞLI ALLEN ANAHTAR 6 MM	46,35	143	5545240005	KONİK PİM ZIMBA 5 MM	35,25	148
4921220070	T TİPİ YUVARLAK BAŞLI ALLEN ANAHTAR 7 MM	48,60	143	5545240006	KONİK PİM ZIMBA 6 MM	51,95	148
4921220080	T TİPİ YUVARLAK BAŞLI ALLEN ANAHTAR 8 MM	52,25	143	5545240007	KONİK PİM ZIMBA 7 MM	54,15	148
4921220100	T TİPİ YUVARLAK BAŞLI ALLEN ANAHTAR 10 MM	86,65	143	5545240008	KONİK PİM ZIMBA 8 MM	56,25	148
4922008108	ELTA T TİPİ ALLEN ANAHTAR TAKIMI 8 PARÇA MM	234,20	195	5545240009	KONİK PİM ZIMBA 9 MM	57,55	148
4922220025	ELTA T TİPİ ALLEN ANAHTAR 2.5 MM	21,15	195	5545240010	KONİK PİM ZIMBA 10 MM	58,70	148
4922220030	ELTA T TİPİ ALLEN ANAHTAR 3 MM	21,25	195	5545240012	KONİK PİM ZIMBA 12 MM	61,35	148
4922220040	ELTA T TİPİ ALLEN ANAHTAR 4 MM	21,45	195	5545240103	KONİK PİM ZIMBA KROM KAPLI 3 MM	32,10	148
4922220050	ELTA T TİPİ ALLEN ANAHTAR 5 MM	24,35	195	5546240002	ELTA KONİK PİM ZIMBA 2 MM	18,70	196
4922220060	ELTA T TİPİ ALLEN ANAHTAR 6 MM	26,75	195	5546240003	ELTA KONİK PİM ZIMBA 3 MM	18,70	196
4922220070	ELTA T TİPİ ALLEN ANAHTAR 7 MM	27,65	195	5546240004	ELTA KONİK PİM ZIMBA 4 MM	18,70	196
4922220080	ELTA T TİPİ ALLEN ANAHTAR 8 MM	33,35	195	5546240005	ELTA KONİK PİM ZIMBA 5 MM	18,70	196
4922220100	ELTA T TİPİ ALLEN ANAHTAR 10 MM	58,25	195	5546240006	ELTA KONİK PİM ZIMBA 6 MM	18,70	196
5010008106	ISKARPELA TAKIM 6 PARÇA	366,50	147	5546240007	ELTA KONİK PİM ZIMBA 7 MM	21,55	196
5010230006	ISKARPELA DÜZ 06 MM	44,90	147	5546240008	ELTA KONİK PİM ZIMBA 8 MM	21,55	196
5010230008	ISKARPELA DÜZ 08 MM	48,00	147	5546240009	ELTA KONİK PİM ZIMBA 9 MM	23,60	196
5010230010	ISKARPELA DÜZ 10 MM	50,75	147	5546240010	ELTA KONİK PİM ZIMBA 10 MM	23,60	196
5010230012	ISKARPELA DÜZ 12 MM	55,65	147	5550001006	DÜZ PİM ZIMBA TAKIMI 6 PARÇA	236,40	148
5010230014	ISKARPELA DÜZ 14 MM	57,55	147	5550240002	DÜZ PİM ZIMBA 2 MM	37,70	148
5010230016	ISKARPELA DÜZ 16 MM	61,55	147	5550240003	DÜZ PİM ZIMBA 3 MM	37,70	148
5010230018	ISKARPELA DÜZ 18 MM	66,75	147	5550240004	DÜZ PİM ZIMBA 4 MM	38,35	148
5010230020	ISKARPELA DÜZ 20 MM	74,25	147	5550240005	DÜZ PİM ZIMBA 5 MM	38,35	148
5010230022	ISKARPELA DÜZ 22 MM	80,45	147	5550240006	DÜZ PİM ZIMBA 6 MM	38,65	148
5010230024	ISKARPELA DÜZ 24 MM	86,90	147	5550240007	DÜZ PİM ZIMBA 7 MM	40,25	148
5010230026	ISKARPELA DÜZ 26 MM	90,05	147	5550240008	DÜZ PİM ZIMBA 8 MM	43,10	148
5010230030	ISKARPELA DÜZ 30 MM	96,15	147	5550240009	DÜZ PİM ZIMBA 9 MM	43,70	148
5011230006	ELTA ISKARPELA DÜZ 06 MM	37,25	195	5550240010	DÜZ PİM ZIMBA 10 MM	44,15	148
5011230008	ELTA ISKARPELA DÜZ 08 MM	39,40	195	5550240105	DÜZ PİM ZIMBA KROM KAPLI 5 MM	36,10	148
5011230010	ELTA ISKARPELA DÜZ 10 MM	41,70	195	5551240002	ELTA DÜZ PİM ZIMBA 2 MM	24,75	196
5011230012	ELTA ISKARPELA DÜZ 12 MM	45,75	195	5551240006	ELTA DÜZ PİM ZIMBA 6 MM	29,15	196
5011230014	ELTA ISKARPELA DÜZ 14 MM	47,35	195	5551240008	ELTA DÜZ PİM ZIMBA 8 MM	29,15	196
5011230016	ELTA ISKARPELA DÜZ 16 MM	50,55	195	5551240010	ELTA DÜZ PİM ZIMBA 10 MM	33,25	196
5011230018	ELTA ISKARPELA DÜZ 18 MM	54,90	195	5600006106	KESKİ ZIMBA TAKIMI 6 PARÇA	237,55	149
5011230020	ELTA ISKARPELA DÜZ 20 MM	60,90	195	5700002110	KAYIŞ ZIMBA TAKIMI 10 PARÇA	336,25	149
5011230022	ELTA ISKARPELA DÜZ 22 MM	66,20	195	5700002112	KAYIŞ ZIMBA TAKIMI 12 PARÇA	447,05	149
5011230024	ELTA ISKARPELA DÜZ 24 MM	71,35	195	5700240003	KAYIŞ ZIMBA 3 MM	24,20	149
5011230026	ELTA ISKARPELA DÜZ 26 MM	74,05	195	5700240004	KAYIŞ ZIMBA 4 MM	25,30	149
5011230030	ELTA ISKARPELA DÜZ 30 MM	78,95	195	5700240005	KAYIŞ ZIMBA 5 MM	27,50	149
5500230100	DÜZ KESKİ 100 MM	29,90	147	5700240006	KAYIŞ ZIMBA 6 MM	28,00	149
5500230125	DÜZ KESKİ 125 MM	35,95	147	5700240007	KAYIŞ ZIMBA 7 MM	30,85	149
5500230150	DÜZ KESKİ 150 MM	46,25	147	5700240008	KAYIŞ ZIMBA 8 MM	32,80	149
5500230175	DÜZ KESKİ 175 MM	52,20	147	5700240009	KAYIŞ ZIMBA 9 MM	36,60	149
5500230200	DÜZ KESKİ 200 MM	72,60	147	5700240010	KAYIŞ ZIMBA 10 MM	38,95	149
5500230250	DÜZ KESKİ 250 MM	89,35	147	5700240011	KAYIŞ ZIMBA 11 MM	41,90	149
5500230300	DÜZ KESKİ 300 MM	143,15	147	5700240012	KAYIŞ ZIMBA 12 MM	50,15	149
5500231250	DÜZ KESKİ KALKAN İZOLELİ 250 MM	113,70	147	5700240013	KAYIŞ ZIMBA 13 MM	52,80	149
5500231300	DÜZ KESKİ KALKAN İZOLELİ 300 MM	165,75	147	5700240014	KAYIŞ ZIMBA 14 MM	58,00	149
5501230100	ELTA DÜZ KESKİ 100 MM	24,20	195	5700240015	KAYIŞ ZIMBA 15 MM	66,55	149
5501230125	ELTA DÜZ KESKİ 125 MM	27,45	195	5700240016	KAYIŞ ZIMBA 16 MM	72,85	149
5501230150	ELTA DÜZ KESKİ 150 MM	36,25	195	5700240017	KAYIŞ ZIMBA 17 MM	79,65	149
5501230175	ELTA DÜZ KESKİ 175 MM	40,80	195	5700240018	KAYIŞ ZIMBA 18 MM	86,90	149
5501230200	ELTA DÜZ KESKİ 200 MM	52,15	195	5700240019	KAYIŞ ZIMBA 19 MM	94,45	149
5501230250	ELTA DÜZ KESKİ 250 MM	64,10	195	5700240020	KAYIŞ ZIMBA 20 MM	100,60	149
5501230300	ELTA DÜZ KESKİ 300 MM	102,70	195	5700241021	KAYIŞ ZIMBA 21 MM	100,80	149
5510230125	TESVİYECİ DÜZ KESKİ 125 MM	40,95	148	5700241022	KAYIŞ ZIMBA 22 MM	102,15	149
5510230150	TESVİYECİ DÜZ KESKİ 150 MM	51,20	148	5700241023	KAYIŞ ZIMBA 23 MM	103,70	149
5520230125	TIRNAK KESKİ 130 MM	45,95	148	5700241024	KAYIŞ ZIMBA 24 MM	110,40	149
5520230150	TIRNAK KESKİ 150 MM	54,80	148	5700241025	KAYIŞ ZIMBA 25 MM	116,20	149
5521230125	ELTA TIRNAK KESKİ 125 MM	23,65	196	5700241026	KAYIŞ ZIMBA 26 MM	122,50	149
5521230150	ELTA TIRNAK KESKİ 150 MM	31,55	196	5700241029	KAYIŞ ZIMBA 29 MM	139,20	149
5540240412	NOKTA ZIMBA KROM KAPLI 4X120	31,25	148	5700241030	KAYIŞ ZIMBA 30 MM	141,15	149

KOD	ÜRÜN	FİYAT	SAYFA
5700241032	KAYIŞ ZIMBA 32 MM	149,30	149
5701240003	ELTA KAYIŞ ZIMBA 03 MM	17,30	196
5701240004	ELTA KAYIŞ ZIMBA 04 MM	18,15	196
5701240005	ELTA KAYIŞ ZIMBA 05 MM	19,70	196
5701240006	ELTA KAYIŞ ZIMBA 06 MM	20,10	196
5701240007	ELTA KAYIŞ ZIMBA 07 MM	22,10	196
5701240008	ELTA KAYIŞ ZIMBA 08 MM	23,60	196
5701240009	ELTA KAYIŞ ZIMBA 09 MM	26,25	196
5701240010	ELTA KAYIŞ ZIMBA 10 MM	28,00	196
5701240011	ELTA KAYIŞ ZIMBA 11 MM	30,00	196
5701240012	ELTA KAYIŞ ZIMBA 12 MM	35,95	196
5701240013	ELTA KAYIŞ ZIMBA 13 MM	37,95	196
5701240014	ELTA KAYIŞ ZIMBA 14 MM	41,55	196
5701240015	ELTA KAYIŞ ZIMBA 15 MM	47,70	196
5701240016	ELTA KAYIŞ ZIMBA 16 MM	52,20	196
5701240017	ELTA KAYIŞ ZIMBA 17 MM	57,10	196
5701240018	ELTA KAYIŞ ZIMBA 18 MM	58,80	196
5701240019	ELTA KAYIŞ ZIMBA 19 MM	67,75	196
5701240020	ELTA KAYIŞ ZIMBA 20 MM	72,15	196
5800250001	100 GR TESVİYECİ ÇEKİÇ YEDEK SAP KAMALI	17,45	201
5800250002	200 GR TESVİYECİ ÇEKİÇ YEDEK SAP KAMALI	17,50	201
5800250003	300 GR TESVİYECİ ÇEKİÇ YEDEK SAP KAMALI	19,55	201
5800250005	500 GR TESVİYECİ ÇEKİÇ YEDEK SAP KAMALI	21,95	201
5800250010	1000 GR TESVİYECİ ÇEKİÇ YEDEK SAP KAMALI	28,50	201
5800250015	1500 GR TESVİYECİ ÇEKİÇ YEDEK SAP KAMALI	32,10	201
5800250020	2000 GR TESVİYECİ ÇEKİÇ YEDEK SAP KAMALI	34,60	201
5800250100	TESVİYECİ ÇEKİÇ 100 GR	52,65	150
5800250200	TESVİYECİ ÇEKİÇ 200 GR	57,35	150
5800250300	TESVİYECİ ÇEKİÇ 300 GR	69,50	150
5800250500	TESVİYECİ ÇEKİÇ 500 GR	80,45	150
5800251000	TESVİYECİ ÇEKİÇ 1000 GR	112,35	150
5800251500	TESVİYECİ ÇEKİÇ 1500 GR	152,70	150
5800252000	TESVİYECİ ÇEKİÇ 2000 GR	187,80	150
5801250100	ELTA TESVİYECİ ÇEKİÇ 100 GR	32,40	196
5801250200	ELTA TESVİYECİ ÇEKİÇ 200 GR	43,60	196
5801250500	ELTA TESVİYECİ ÇEKİÇ 500 GR	67,20	196
5801251000	ELTA TESVİYECİ ÇEKİÇ 1000 GR	103,05	196
5801251500	ELTA TESVİYECİ ÇEKİÇ 1500 GR	140,15	196
5801252000	ELTA TESVİYECİ ÇEKİÇ 2000 GR	172,40	196
5810251000	EMNİYET ÇEKİCİ 1000 GR	151,65	150
5810251500	EMNİYET ÇEKİCİ 1500 GR	209,85	150
5810252000	EMNİYET ÇEKİCİ 2000 GR	259,20	150
5850250030	PLASTİK ÇEKİÇ 30 MM	71,20	150
5850250040	PLASTİK ÇEKİÇ 40 MM	86,65	150
5850250050	PLASTİK ÇEKİÇ 50 MM	108,30	150
5850250130	30MM PLASTİK ÇEKİÇ YEDEK BAŞLIK	16,95	201
5850250140	40MM PLASTİK ÇEKİÇ YEDEK BAŞLIK	24,20	201
5850250150	50MM PLASTİK ÇEKİÇ YEDEK BAŞLIK	34,65	201
5851250030	ELTA PLASTİK ÇEKİÇ 30 MM	51,80	197
5851250130	ELTA PLASTİK ÇEKİÇ YEDEK BAŞLIK 30 MM	11,95	203
5851250140	ELTA PLASTİK ÇEKİÇ YEDEK BAŞLIK 40 MM	17,20	203
5865250001	1000 GR MADIRGA YEDEK SAP KAMALI	20,55	201
5865250002	1500 GR MADIRGA YEDEK SAP KAMALI	22,55	201
5865251000	MADIRGA 1000 GR	138,95	151
5865251500	MADIRGA 1500 GR	166,00	151
5870250400	LASTİK ÇEKİÇ 400 GR	145,80	150
5884260003	ELTA PLASTİK ŞERİT METRE 3 M	17,75	197
5884260005	ELTA PLASTİK ŞERİT METRE 5 M	25,60	197
5891260830	ELTA TESTERE KOLU 300 mm	63,50	197
6195260260	PERÇİN TABANCASI 260 MM	169,05	157
6205270240	ALÜMİNYUM VE SAC KESME MAKASI 240 MM (SAĞ)	124,00	167
6206270240	ALÜMİNYUM VE SAC KESME MAKASI 240 MM (SOL)	124,00	167
6207270240	ALÜMİNYUM VE SAC KESME MAKASI 240 MM (DÜZ)	124,00	167
6210270250	KAPORTACI MAKASI 250 MM (SAG)	155,00	168
6210270275	KAPORTACI MAKASI 275 MM (SAĞ)	169,55	168
6210270300	KAPORTACI MAKASI 300 MM (SAG)	203,25	168
6211270250	KAPORTACI MAKASI 250 MM (SOL)	155,00	168

KOD	ÜRÜN	FİYAT	SAYFA
6211270275	KAPORTACI MAKASI 275 MM (SOL)	169,55	168
6211270300	KAPORTACI MAKASI 300 MM (SOL)	203,25	168
6220260500	SPIRALLİ MIKNATIS 500 GR	99,30	157
6220261000	SPIRALLİ MIKNATIS 1000 GR	105,15	157
6225260200	MADENİ YAĞDANLIK FLEXIBLE UÇLU 200 cc	58,50	157
6225260300	MADENİ YAĞDANLIK FLEXIBLE UÇLU 300 cc	65,85	157
6225260500	MADENİ YAĞDANLIK FLEXIBLE UÇLU 500 cc	72,25	157
6230260300	GRES POMPASI (300 CC)	101,50	159
6230260500	GRES POMPASI (500 CC)	119,05	159
6230262500	GRES POMPASI UCU (300 CC VE 500 CC)	10,10	202
6230263300	300 CC GRES POMPASI HORTUMU	13,20	202
6230263500	500 CC GRES POMPASI HORTUMU	24,25	202
6235190220	SÜBAP AYAR TORNAVİDASI 220 MM	36,60	159
6240260810	TAPA ANAHTARI İKİ AĞIZ 8x10 MM	53,45	159
6350260300	LEVYE OLUKLU 300 MM	50,75	159
6350260400	LEVYE OLUKLU 400 MM	63,95	159
6350260500	LEVYE OLUKLU 500 MM	89,00	159
6350260600	LEVYE OLUKLU 600 MM	108,65	159
6351260400	ELTA LEVYE OLUKLU 400 MM	45,65	197
6351260500	ELTA LEVYE OLUKLU 500 MM	64,75	197
6351260600	ELTA LEVYE OLUKLU 600 MM	87,20	197
6360260600	LEVYE OLUKLU KIVRIK UÇLU 600 MM	120,05	159
6370260100	YAĞ FİLTRESİ SÖKECEĞİ 75-100 MM	79,30	159
6371263120	ÜÇ AYAKLI YAĞ FİLTRE SÖKECEĞİ 63-120 MM	151,25	159
6375266510	ÇİFT YÖNLÜ ÜÇ AYAKLI YAĞ FİLTRESİ SÖKECEĞİ (SÖKME TAKMA) 75-120 MM	277,50	160
6380260016	ÇİFT ZİNCİRLİ YAĞ FİLTRESİ SÖKECEĞİ 60x160 MM	708,60	160
6400250001	400 GR KESER SAPI	21,95	201
6400250600	KESER 400 GR	153,20	151
6401250600	USTA KESERİ 400 GR	153,20	151
6410250001	NACAK SAP (KAMALI)	66,50	201
6410250800	NACAK 800 GR	277,50	151
6710270230	BAG MAKASI 230 MM (LÜKS)	119,50	170
6712270210	ELMA MAKASI 210 MM	211,40	170
6715270225	BAĞ MAKASI 225 MM (COMFORT TİP)	182,00	170
6720270220	BAĞ MAKASI 220 MM (HAFİF TİP)	211,05	170
6721270205	ELTA BAĞ MAKASI (LÜX) 205 MM	85,25	197
6722270220	ELTA BAĞ MAKASI (HAFİF TİP) 220 MM	123,00	197
6730270550	ELTA ÇİM KESME MAKASI (DÜZ AĞIZ) 550 MM	105,30	198
6731270650	ELTA ÇİM KESME MAKASI (EĞRİ AĞIZ) 650 MM	188,20	198
6735270300	DAL BUDAMA TESTERESİ 300 MM	160,55	156
6735271300	DAL BUDAMA TESTERESİ YEDEK BIÇAK 300 MM	117,30	202
6740270140	KOMBİNE MAKAS 140 MM	121,95	169
6740270190	KOMBİNE MAKAS 190 MM	138,15	169
6760270125	NARENÇİYE MAKASI 125 MM	95,10	170
6800270180	KUYUMCU MAKASI DÜZ 180 MM	143,45	169
6801270180	KUYUMCU MAKASI EĞRİ 180 MM	156,90	169
6815270200	TEL KESME MAKASI 200 MM	63,95	169
6820270200	TENEKECİ MAKASI 200 MM	107,90	168
6820270250	TENEKECİ MAKASI 250 MM	137,80	168
6820270300	TENEKECİ MAKASI 300 MM	150,20	168
6821270250	TENEKECİ MAKASI 250 MM YAYLI	149,65	168
6821270300	TENEKECİ MAKASI 300 MM YAYLI	163,75	168
6850280322	MINİ BORU KESİCİ (BAKIR VE ALÜMİNYUM İÇİN)	94,80	171
6850281322	MINİ-STANDART-TELESKOPIK BORU KESİCİ YEDEK BIÇAĞI	26,00	202
6855280330	STANDART BORU KESİCİ (BAKIR VE ALÜMİNYUM İÇİN)	131,25	171
6860280635	TELESKOPIK BORU KESİCİ (BAKIR VE ALÜMİNYUM İÇİN)	279,15	171
6865280150	PROFESYONEL BORU KESİCİ YEDEK BIÇAĞI	53,90	202
6865281050	PROFESYONEL BORU KESİCİ (ÇELİK İÇİN)	704,65	171
7010006105	ÇEKİTİRME SEHPASI DOLU (5 PARÇA)	3.206,60	175
7010290810	STANDART ÇEKİTİRME 8X10 (İKİ KOLLU)	330,50	175
7010290822	STANDART ÇEKİTİRME YEDEK KOL (8X10-12X10)	59,65	203
7010290833	STANDART ÇEKİTİRME BAĞLANTI PARÇASI (8X10-12X10)	30,05	203
7010290844	STANDART ÇEKİTİRME YEDEK MİL (8X10-12X10)	54,55	203
7010291210	STANDART ÇEKİTİRME 12X10 (İKİ KOLLU)	353,40	175
7010291615	STANDART ÇEKİTİRME 16X15 (İKİ KOLLU)	602,50	175
7010291622	STANDART ÇEKİTİRME YEDEK KOL (16X15-20X15)	103,80	203
7010291633	STANDART ÇEKİTİRME BAĞLANTI PARÇASI (16X15-20X15)	51,95	203

KOD	ÜRÜN	FİYAT	SAYFA	KOD	ÜRÜN	FİYAT	SAYFA
7010291644	STANDART ÇEKTİRME YEDEK MİL (16X15-20X15)	104,25	203	7120294350	İÇ RULMAN ÇEKTİRME PENSLERİ 43-50 MODEL A	554,20	178
7010292015	STANDART ÇEKTİRME 20X15 (İKİ KOLLU)	659,05	175	7120294555	İÇ RULMAN ÇEKTİRME PENSLERİ 45-55 MODEL A	587,85	178
7010292033	STANDART ÇEKTİRME UZATMA PARÇASI 200 MM (8X10-12X10)	79,30	203	7120295060	İÇ RULMAN ÇEKTİRME PENSLERİ 50-60 MODEL A	636,10	178
7010292520	STANDART ÇEKTİRME 25X20 (İKİ KOLLU)	1.138,30	175	7120296013	İÇ RULMAN ÇEKTİRME KOLLARI 60-130	627,30	178
7010292522	STANDART ÇEKTİRME YEDEK KOL (25X20-35X20-52X20-37X20)	182,00	203	7122290560	DIŞ RULMAN ÇEKTİRME ÇENELERİ 05-60	469,90	179
7010292533	STANDART ÇEKTİRME BAĞLANTI PARÇASI (25X20-35X20-52X20-37X20)	91,00	203	7122291036	DIŞ RULMAN ÇEKTİRME KOLLARI 100-360	4.039,65	179
7010292544	STANDART ÇEKTİRME YEDEK MİL (25X20)	179,35	203	7122291275	DIŞ RULMAN ÇEKTİRME ÇENELERİ 12-75	588,70	179
7010293033	STANDART ÇEKTİRME UZATMA PARÇASI 300 MM (16X15-20X15)	138,05	203	7122291443	DIŞ RULMAN ÇEKTİRME KOLLARI 140-435	7.895,65	179
7010293520	STANDART ÇEKTİRME 35X20 (İKİ KOLLU)	1.382,50	175	7122292211	DIŞ RULMAN ÇEKTİRME ÇENELERİ 22-115	919,30	179
7010293544	STANDART ÇEKTİRME YEDEK MİL (35X20-37X20)	233,65	203	7122292515	DIŞ RULMAN ÇEKTİRME ÇENELERİ 25-155	1.439,05	179
7010294033	STANDART ÇEKTİRME UZATMA PARÇASI 400 MM (25X20-35X20-52X20-37X20)	204,25	203	7122293022	DIŞ RULMAN ÇEKTİRME ÇENELERİ 30-220	3.932,90	179
7010295220	STANDART ÇEKTİRME 52X20 (İKİ KOLLU)	2.032,30	175	7122294011	DIŞ RULMAN ÇEKTİRME KOLLARI 40-115	875,85	179
7010295244	STANDART ÇEKTİRME YEDEK MİL (52X20)	233,65	203	7122294028	DIŞ RULMAN ÇEKTİRME ÇENELERİ 40-280	8.784,25	179
7010316105	ÇEKTİRME SEHPASI (BOŞ)	122,85	206	7122295520	DIŞ RULMAN ÇEKTİRME KOLLARI 55-205	1.386,45	179
7020293720	STANDART ÇEKTİRME 37X20 (ÜÇ KOLLU)	2.551,25	175	7122299026	DIŞ RULMAN ÇEKTİRME KOLLARI 90-260	1.962,90	179
7020295220	STANDART ÇEKTİRME 52X20 (ÜÇ KOLLU)	3.517,05	175	7125290045	45 MM ROTİL ÇEKTİRME (ÇATAL)	570,85	179
7030290808	MASTER ÇEKTİRME 8X8 (İKİ KOLLU)	133,05	176	7126290018	18 MM ROTİL ÇEKTİRME	271,70	179
7030290822	MASTER ÇEKTİRME YEDEK KOL (8X8)	32,60	203	7126290025	25 MM ROTİL ÇEKTİRME	372,50	179
7030290844	MASTER ÇEKTİRME YEDEK MİL 8X8	44,30	203	7126290029	29 MM ROTİL ÇEKTİRME	495,50	179
7030291212	MASTER ÇEKTİRME 12X12 (İKİ KOLLU)	274,45	176	7126290040	40 MM ROTİL ÇEKTİRME	699,55	179
7030291222	MASTER ÇEKTİRME YEDEK KOL (12X12)	45,25	203	7126290045	45 MM ROTİL ÇEKTİRME	883,20	179
7030291244	MASTER ÇEKTİRME YEDEK MİL 12X12	65,25	203	7300301012	İŞKENCE 100x12 (MARANGOZ MENGENESİ PLASTİK AĞIZLI)	309,50	164
7030291616	MASTER ÇEKTİRME 16X16 (İKİ KOLLU)	413,05	176	7300303012	İŞKENCE 30x12 (MARANGOZ MENGENESİ PLASTİK AĞIZLI)	188,75	164
7030291622	MASTER ÇEKTİRME YEDEK KOL (16X16)	80,85	203	7300304012	İŞKENCE 40x12 (MARANGOZ MENGENESİ PLASTİK AĞIZLI)	238,90	164
7030291644	MASTER ÇEKTİRME YEDEK MİL 16X16	72,05	203	7300305012	İŞKENCE 50x12 (MARANGOZ MENGENESİ PLASTİK AĞIZLI)	244,90	164
7030292320	MASTER ÇEKTİRME 23X20 (İKİ KOLLU)	561,60	176	7300306012	İŞKENCE 60x12 (MARANGOZ MENGENESİ PLASTİK AĞIZLI)	255,65	164
7030292322	MASTER ÇEKTİRME YEDEK KOL (23X20)	110,00	203	7300308012	İŞKENCE 80x12 (MARANGOZ MENGENESİ PLASTİK AĞIZLI)	271,15	164
7030292344	MASTER ÇEKTİRME YEDEK MİL 23X20	98,75	203	7300316150	İŞKENCE SEHPASI (BOŞ)	502,85	206
7040290808	MASTER ÇEKTİRME 8X8 (ÜÇ KOLLU)	254,95	176	7310301005	MİNİ İŞKENCE 10x5	72,25	164
7040291212	MASTER ÇEKTİRME 12X12 (ÜÇ KOLLU)	373,15	176	7310301505	MİNİ İŞKENCE 15x5	76,15	164
7040291616	MASTER ÇEKTİRME 16X16 (ÜÇ KOLLU)	548,75	176	7310302005	MİNİ İŞKENCE 20x5	78,95	164
7040292320	MASTER ÇEKTİRME 23X20 (ÜÇ KOLLU)	738,90	176	7310302505	MİNİ İŞKENCE 25x5	82,30	164
7050290422	BATARYA ÇEKTİRME YEDEK KOL 6X4	25,40	203	7310303005	MİNİ İŞKENCE 30x5	85,20	164
7050290444	BATARYA ÇEKTİRME YEDEK MİL 6X4	37,75	203	7400000100	DÖVME ÇELİK MENGENE (DÖNER TABLA DAHİL) 100 MM	1.126,00	163
7050290604	BATARYA ÇEKTİRME 6X4 (İKİ KOLLU)	148,10	176	7400000125	DÖVME ÇELİK MENGENE (DÖNER TABLA DAHİL) 125 MM	1.536,05	163
7050290606	BATARYA ÇEKTİRME 6X6 (İKİ KOLLU)	152,70	176	7400000150	DÖVME ÇELİK MENGENE (DÖNER TABLA DAHİL) 150 MM	1.942,55	163
7050290622	BATARYA ÇEKTİRME YEDEK KOL 6X6	28,35	203	7400000175	DÖVME ÇELİK MENGENE (DÖNER TABLA DAHİL) 175 MM	2.349,05	163
7050290644	BATARYA ÇEKTİRME YEDEK MİL 6X6	42,20	203	7400300100	DÖVME ÇELİK MENGENE 100 MM	869,90	163
7050290808	BATARYA ÇEKTİRME 8X8 (İKİ KOLLU)	160,35	176	7400300125	DÖVME ÇELİK MENGENE 125 MM	1.197,65	163
7050290822	BATARYA ÇEKTİRME YEDEK KOL 8X8	32,60	203	7400300150	DÖVME ÇELİK MENGENE 150 MM	1.531,75	163
7050290844	BATARYA ÇEKTİRME YEDEK MİL 8X8	53,15	203	7400300175	DÖVME ÇELİK MENGENE 175 MM	1.884,60	163
7060290604	BATARYA ÇEKTİRME 6X4 (ÜÇ KOLLU)	192,25	176	7401300100	MENGENE DÖNER TABLASI 100 MM	256,10	163
7060290606	BATARYA ÇEKTİRME 6X6 (ÜÇ KOLLU)	242,40	176	7401300125	MENGENE DÖNER TABLASI 125 MM	338,40	163
7060290808	BATARYA ÇEKTİRME 8X8 (ÜÇ KOLLU)	281,20	176	7401300150	MENGENE DÖNER TABLASI 150 MM	410,80	163
7070292013	S TİPİ ÇEKTİRME 20X13 (İKİ KOLLU)	364,75	177	7401300175	MENGENE DÖNER TABLASI 175 MM	464,45	163
7070292022	S TİPİ ÇEKTİRME YEDEK KOL 20X13	65,35	203	8001316012	ÇATAL ANAHTAR SEHPASI (BOŞ)	65,25	207
7070292044	S TİPİ ÇEKTİRME YEDEK MİL 20X13	91,10	203	8002316012	YILDIZ ANAHTAR SEHPASI (BOŞ)	81,35	207
7080292013	S TİPİ ÇEKTİRME 20X13 (ÜÇ KOLLU)	470,40	177	8004316004	DÖVME ÇELİK MENGENE SEHPASI (BOŞ)	623,35	207
7090292222	ÜNİVERSAL ÇEKTİRME 22X22 (İKİ KOLLU)	405,30	177	8010316001	İZELTAS TEŞHİR PANOSU	1.696,50	208
7090292244	ÜNİVERSAL ÇEKTİRME YEDEK MİL 22X22	95,90	203	8011316001	ELTA TEŞHİR PANOSU	1.404,00	198
7090292322	ÜNİVERSAL ÇEKTİRME YEDEK KOL 22X22	72,60	203	8015316001	TEKERLİKLİ ÜÇGEN TEŞHİR STANDI	883,95	207
7100292222	ÜNİVERSAL ÇEKTİRME 22X22 (ÜÇ KOLLU)	531,30	177	8160326001	TAKIM DOLABI (BOŞ) 250X643X943	1.633,50	27
7120290507	İÇ RULMAN ÇEKTİRME PENSLERİ 5-7 MODEL A	303,85	178	8210326001	VAGON SERİSİ TAKIM DOLABI	2.130,85	26
7120290709	İÇ RULMAN ÇEKTİRME PENSLERİ 7-9 MODEL A	303,85	178	8235001072	PARTNER SERİSİ DOLAP 1. ÇEKMECE İÇİ 69 PARÇA	1.967,40	20
7120290912	İÇ RULMAN ÇEKTİRME PENSLERİ 9-12 MODEL A	281,60	178	8235002031	PARTNER SERİSİ DOLAP 2. ÇEKMECE İÇİ 31 PARÇA	898,10	21
7120291013	İÇ RULMAN ÇEKTİRME PENSLERİ 10-13 MODEL A	281,60	178	8235003017	PARTNER SERİSİ DOLAP 3. ÇEKMECE İÇİ 17 PARÇA	846,85	21
7120291317	İÇ RULMAN ÇEKTİRME PENSLERİ 13-17 MODEL A	281,60	178	8235006121	PARTNER SERİSİ TAKIM DOLABI 5 ÇEKMECELİ KIRMIZI (DOLU-118)	6.842,45	19
7120291419	İÇ RULMAN ÇEKTİRME PENSLERİ 14-19 MODEL A	288,45	178	8235325005	PARTNER SERİSİ TAKIM DOLABI 5 ÇEKMECELİ MAVİ (BOŞ)	3.130,10	19
7120291621	İÇ RULMAN ÇEKTİRME PENSLERİ 16-21 MODEL A	288,45	178	8235326005	PARTNER SERİSİ TAKIM DOLABI 5 ÇEKMECELİ KIRMIZI (BOŞ)	3.130,10	19
7120291823	İÇ RULMAN ÇEKTİRME PENSLERİ 18-23 MODEL A	345,30	178	8235327005	PARTNER SERİSİ TAKIM DOLABI 5 ÇEKMECELİ SİYAH (BOŞ)	3.130,10	19
7120292025	İÇ RULMAN ÇEKTİRME PENSLERİ 20-25 MODEL A	364,55	178	8241001030	PRO DOLAP 1. ÇEKMECE İÇİ 30 PARÇA	905,60	12
7120292530	İÇ RULMAN ÇEKTİRME PENSLERİ 25-30 MODEL A	379,70	178	8241001209	PRO SERİSİ TAKIM DOLABI ÇEKMECELİ KIRMIZI (DOLU - 206)	11.918,30	11
7120292540	İÇ RULMAN ÇEKTİRME PENSLERİ 25-40 MODEL B	615,40	178	8241002072	PRO DOLAP 2. ÇEKMECE İÇİ 69 PARÇA	1.756,30	12
7120293037	İÇ RULMAN ÇEKTİRME PENSLERİ 30-37 MODEL A	439,95	178	8241003051	PRO DOLAP 3. ÇEKMECE İÇİ 51 PARÇA	808,50	12
7120293542	İÇ RULMAN ÇEKTİRME PENSLERİ 35-42 MODEL A	462,35	178	8241004027	PRO DOLAP 4. ÇEKMECE İÇİ 27 PARÇA	1.338,75	13
7120293575	İÇ RULMAN ÇEKTİRME KOLLARI 35-75	309,60	178	8241005010	PRO DOLAP 5. ÇEKMECE İÇİ 10 PARÇA	1.211,05	13
7120293845	İÇ RULMAN ÇEKTİRME PENSLERİ 38-45 MODEL A	487,40	178	8241006018	PRO DOLAP 6. ÇEKMECE İÇİ 18 PARÇA	656,95	13

KOD	ÜRÜN	FİYAT	SAYFA
8241321005	PRO SERİSİ TAKIM DOLABI 5 ÇEKMECELİ GRİ GÖVDE - KIRMIZI ÇEKMECE	3.850,35	11
8241321006	PRO SERİSİ TAKIM DOLAB 6 ÇEKMECELİ GRİ GÖVDE - KIRMIZI ÇEKMECE	4.160,70	11
8241321007	PRO SERİSİ TAKIM DOLAB 7 ÇEKMECELİ GRİ GÖVDE - KIRMIZI ÇEKMECE	4.916,90	11
8241321008	PRO SERİSİ TAKIM DOLAB 8 ÇEKMECELİ GRİ GÖVDE - KIRMIZI ÇEKMECE	5.241,15	11
8241322005	PRO SERİSİ TAKIM DOLAB 5 ÇEKMECELİ GRİ GÖVDE - MAVİ ÇEKMECE	3.850,35	11
8241322006	PRO SERİSİ TAKIM DOLAB 6 ÇEKMECELİ GRİ GÖVDE - MAVİ ÇEKMECE	4.160,70	11
8241322007	PRO SERİSİ TAKIM DOLAB 7 ÇEKMECELİ GRİ GÖVDE - MAVİ ÇEKMECE	4.916,90	11
8241322008	PRO SERİSİ TAKIM DOLAB 8 ÇEKMECELİ GRİ GÖVDE - MAVİ ÇEKMECE	5.241,15	11
8241323005	PRO SERİSİ TAKIM DOLAB 5 ÇEKMECELİ GRİ GÖVDE - GRİ ÇEKMECE	3.850,35	11
8241323006	PRO SERİSİ TAKIM DOLAB 6 ÇEKMECELİ GRİ GÖVDE - GRİ ÇEKMECE	4.160,70	11
8241323007	PRO SERİSİ TAKIM DOLAB 7 ÇEKMECELİ GRİ GÖVDE - GRİ ÇEKMECE	4.916,90	11
8241323008	PRO SERİSİ TAKIM DOLAB 8 ÇEKMECELİ GRİ GÖVDE - GRİ ÇEKMECE	5.241,15	11
8242001030	GARAJ SERİSİ DOLAP 1. ÇEKMECE İÇİ 30 PARÇA	905,60	16
8242001142	GARAJ SERİSİ TAKIM DOLABI 7 ÇEKMECELİ KIRMIZI (DOLU -139)	9.780,60	15
8242002072	GARAJ SERİSİ DOLAP 2. ÇEKMECE İÇİ 69 PARÇA	1.756,30	16
8242003010	GARAJ SERİSİ DOLAP 3. ÇEKMECE İÇİ 10 PARÇA	1.211,05	17
8242004018	GARAJ SERİSİ DOLAP 4. ÇEKMECE İÇİ 18 PARÇA	656,95	17
8242005011	GARAJ SERİSİ DOLAP 5. ÇEKMECE İÇİ 11 PARÇA	519,20	17
8242008142	GARAJ SERİSİ TAKIM DOLABI 8 ÇEKMECELİ KIRMIZI (DOLU -139)	10.243,20	15
8242321005	GARAJ SERİSİ TAKIM DOLABI 5 ÇEKMECELİ KIRMIZI GÖVDE - GRİ ÇEKMECE	3.440,40	15
8242321006	GARAJ SERİSİ TAKIM DOLABI 6 ÇEKMECELİ KIRMIZI GÖVDE - GRİ ÇEKMECE	4.049,60	15
8242321007	GARAJ SERİSİ TAKIM DOLABI 7 ÇEKMECELİ KIRMIZI GÖVDE - GRİ ÇEKMECE	4.731,50	15
8242321008	GARAJ SERİSİ TAKIM DOLABI 8 ÇEKMECELİ KIRMIZI GÖVDE - GRİ ÇEKMECE	5.194,10	15
8242322005	GARAJ SERİSİ TAKIM DOLABI 5 ÇEKMECELİ MAVİ GÖVDE - GRİ ÇEKMECE	3.440,40	15
8242322006	GARAJ SERİSİ TAKIM DOLABI 6 ÇEKMECELİ MAVİ GÖVDE - GRİ ÇEKMECE	4.049,60	15
8242322007	GARAJ SERİSİ TAKIM DOLABI 7 ÇEKMECELİ MAVİ GÖVDE - GRİ ÇEKMECE	4.731,50	15
8242322008	GARAJ SERİSİ TAKIM DOLABI 8 ÇEKMECELİ MAVİ GÖVDE - GRİ ÇEKMECE	5.194,10	15
8242323005	GARAJ SERİSİ TAKIM DOLABI 5 ÇEKMECELİ GRİ GÖVDE - GRİ ÇEKMECE	3.440,40	15
8242323006	GARAJ SERİSİ TAKIM DOLABI 6 ÇEKMECELİ GRİ GÖVDE - GRİ ÇEKMECE	4.049,60	15
8242323007	GARAJ SERİSİ TAKIM DOLABI 7 ÇEKMECELİ GRİ GÖVDE - GRİ ÇEKMECE	4.731,50	15
8242323008	GARAJ SERİSİ TAKIM DOLABI 8 ÇEKMECELİ GRİ GÖVDE - GRİ ÇEKMECE	5.194,10	15
8243001030	EKO SERİSİ DOLAP 1. ÇEKMECE İÇİ 30 PARÇA	849,80	23
8243001096	EKO SERİSİ TAKIM DOLABI 5 ÇEKMECELİ KIRMIZI (DOLU - 93 -)	5.242,10	22
8243002052	EKO SERİSİ DOLAP 2. ÇEKMECE İÇİ 49 PARÇA	1.226,00	23
8243003013	EKO SERİSİ DOLAP 3. ÇEKMECE İÇİ 13 PARÇA	882,90	23
8243007096	EKO SERİSİ TAKIM DOLABI 7 ÇEKMECELİ KIRMIZI (DOLU - 93 -)	6.019,95	22
8243321005	EKO SERİSİ TAKIM DOLABI 5 ÇEKMECELİ KIRMIZI GÖVDE - GRİ ÇEKMECE	2.283,40	22
8243321007	EKO SERİSİ TAKIM DOLABI 7 ÇEKMECELİ KIRMIZI GÖVDE - GRİ ÇEKMECE	3.061,25	22
8243322005	EKO SERİSİ TAKIM DOLABI 5 ÇEKMECELİ MAVİ GÖVDE - GRİ ÇEKMECE	2.283,40	22
8243322007	EKO SERİSİ TAKIM DOLABI 7 ÇEKMECELİ MAVİ GÖVDE - GRİ ÇEKMECE	3.061,25	22
8243323005	EKO SERİSİ TAKIM DOLABI 5 ÇEKMECELİ GRİ GÖVDE - GRİ ÇEKMECE	2.283,40	22
8243323007	EKO SERİSİ TAKIM DOLABI 7 ÇEKMECELİ GRİ GÖVDE - GRİ ÇEKMECE	3.061,25	22
8244001030	TREND SERİSİ DOLAP 1. ÇEKMECE İÇİ 30 PARÇA	849,80	25
8244002052	TREND SERİSİ DOLAP 2. ÇEKMECE İÇİ 49 PARÇA	1.226,00	25
8244003013	TREND SERİSİ DOLAP 3. ÇEKMECE İÇİ 13 PARÇA	882,90	25
8244005096	TREND SERİSİ TAKIM DOLABI 5 ÇEKMECELİ KIRMIZI (DOLU - 93 -)	5.251,30	24
8244007096	TREND SERİSİ TAKIM DOLABI 7 ÇEKMECELİ KIRMIZI (DOLU - 93 -)	5.345,80	24
8244321005	TREND SERİSİ TAKIM DOLABI 5 ÇEKMECELİ KIRMIZI GÖVDE - GRİ ÇEKMECE	2.292,60	24
8244321007	TREND SERİSİ TAKIM DOLABI 7 ÇEKMECELİ KIRMIZI GÖVDE - GRİ ÇEKMECE	2.387,10	24
8245001042	PREMIUM SERİSİ DOLAP 1. ÇEKMECE İÇİ 42 PARÇA	1.687,20	8
8245002094	PREMIUM SERİSİ DOLAP 2. ÇEKMECE İÇİ 91 PARÇA	1.983,00	8
8245003014	PREMIUM SERİSİ DOLAP 3. ÇEKMECE İÇİ 14 PARÇA	905,90	8
8245004043	PREMIUM SERİSİ DOLAP 4. ÇEKMECE İÇİ 43 PARÇA	976,00	9
8245005043	PREMIUM SERİSİ DOLAP 5. ÇEKMECE İÇİ 43 PARÇA	1.105,15	9
8245006009	PREMIUM SERİSİ DOLAP 6. ÇEKMECE İÇİ 9 PARÇA	2.290,75	9
8245007096	PREMIUM SERİSİ TAKIM DOLABI 7 ÇEKMECE (DOLU 242)	13.768,95	7
8245321005	PREMIUM SERİSİ TAKIM DOLABI 5 ÇEKMECE	3.723,95	7
8245321007	PREMIUM SERİSİ TAKIM DOLABI 7 ÇEKMECE	4.820,95	7
8320331001	ÇEKMECELİ ALET SANDIĞI KÜÇÜK BOY KIRMIZI BOŞ (285X450X322)	1.511,10	32
8320331002	ÇEKMECELİ ALET SANDIĞI ORTA BOY KIRMIZI BOŞ (285X550X322)	1.527,20	32
8320331003	ÇEKMECELİ ALET SANDIĞI BÜYÜK BOY KIRMIZI BOŞ (285X650X322)	1.543,20	32
8410336103	TAKIM ÇANTASI 3 GÖZLÜ KÜÇÜK	182,90	33
8410336203	TAKIM ÇANTASI 3 GÖZLÜ BÜYÜK	218,65	33
8420005028	TESİSATÇI TAKIM ÇANTASI 5 GÖZLÜ 28 PARÇA	1.931,85	35
8420005046	ELEKTRİKÇİ TAKIM ÇANTASI 5 GÖZLÜ 45 PARÇA	2.150,70	35
8420005063	MEKANİKÇİ TAKIM ÇANTASI 5 GÖZLÜ 62 PARÇA	1.966,60	35
8420336105	TAKIM ÇANTASI 5 GÖZLÜ KÜÇÜK	256,25	33

KOD	ÜRÜN	FİYAT	SAYFA
8420336205	TAKIM ÇANTASI 5 GÖZLÜ BÜYÜK	266,05	33
8420336305	TAKIM ÇANTASI 5 GÖZLÜ UZUN	303,15	33
8420336405	TAKIM ÇANTASI 5 GÖZLÜ UZUN 600 MM	408,40	33
8440001023	19" PLASTİK TAKIM ÇANTASI ELEKTRİKÇİ SET DOLU (23 PARÇA)	1.101,05	118
8440331016	PLASTİK TAKIM ÇANTASI 16"	70,20	36
8440331019	PLASTİK TAKIM ÇANTASI 19"	87,75	36
8440331022	PLASTİK TAKIM ÇANTASI 22"	146,25	36
8445331028	TEKERLEKLİ PLASTİK TAKIM ÇANTASI 28"	345,15	36
8500346001	SERVİS MASASI (PANOLU)	4.550,00	30
8501346001	SERVİS MASASI (PANOSUZ)	3.445,00	30
8502346001	DEMONTE SERVİS MASASI	3.289,00	31
8545341005	TAŞIMA ARABASI	2.111,30	29
8550346001	SERVİS ARABASI BÜYÜK BOY	1.497,70	29
8550348001	DEMONTE MİNİ SERVİS ARABASI	958,20	28
8550348002	DEMONTE MİNİ SERVİS ARABASI (KAPALI)	1.105,00	28
8705006113	HOBBY SET OTO TİPİ (13 PARÇA)	529,70	36
8786001003	DOĞADA SET (3 PARÇA)	557,55	37
8790008106	BAKIM ONARIM SETİ (5 PARÇA)	382,10	36
8793001014	BAKIM SETİ (14 PARÇA)	516,90	37
8795006005	1000V İZOLELİ ELEKTRİKÇİ SETİ (5 PARÇA)	504,20	118





*“Dünden bugüne her zaman daha iyisi,
her zaman daha yenisi...”*





**İZELTAŞ EL ALETLERİ
SANAYİ VE TİCARET A.Ş.**

Kemalpaşa Caddesi No: 303
İşikkent İzmir / TÜRKİYE

Sipariş Telefon
Phone for orders

DT: +90 232 472 13 92
T: +90 232 472 13 75
F: +90 232 472 13 78

Adana Bölge Müdürlüğü
Adana Office
+90 533 495 53 09

Ankara Bölge Müdürlüğü
Ankara Office
+90 533 603 47 29

İstanbul Bölge Müdürlüğü
İstanbul Office
+90 533 603 41 81
+90 535 461 54 87



info@izeltas.com.tr
izeltas.com.tr